



Optical Power and Energy Meter

PM400 Operating Manual



2019

Version: 1.1
Date: 19-Dec-2019

Contents

Foreword	3
1 General Information	4
1.1 Ordering Codes and Accessories	4
1.2 Requirements	4
2 Getting Started	5
2.1 Parts List	5
3 Operating Instruction	6
3.1 Operating Elements	6
3.2 Measurement Screens	8
3.2.1 Needle Screen	8
3.2.2 Numerical Display	8
3.2.3 Graph Display	9
3.2.4 Statistics Display	10
3.2.5 Positional Measurement with Sensors S44xC	10
3.3 Measurement Configuration	12
3.4 Spectral Correction	14
3.5 Delta Mode	15
3.6 Zeroing	15
3.7 Attenuation Correction	16
3.8 Data Handling	17
3.9 Subpanels	18
3.10 Main Menu	19
3.11 Charging the Battery	21
3.12 Analog and Auxiliary I/O	21
4 Computer Interface	22
4.1 Software Optical Power Monitor	22
4.2 Using the Instrument Drivers	22
5 Write Your Own Application	24
5.1 Windows XP 32bit	25
5.2 Windows Vista / 7 / 8 - 32bit	26
5.3 Windows Vista / 7 / 8 - 64bit	27
5.4 Simple LabVIEW Example using SCPI commands	29
5.5 SCPI Commands	33
5.5.1 An Introduction to the SCPI language	33
5.5.2 IEEE488.2 Common Commands	36
5.5.2.1 Command Summary	36
5.5.2.2 Command Reference	37
5.5.2.3 PM400 specific SCPI Command Reference	38

6	Maintenance and Service	45
6.1	Version Information _____	45
7	Appendix	46
7.1	Sensor Connector Pinning _____	46
7.2	Technical Data _____	48
7.3	Symbols and Abbreviations _____	51
7.4	Safety _____	52
7.5	Manufacturer Address _____	52
7.6	Certifications and Compliances _____	53
7.7	Warranty _____	54
7.8	Copyright and Exclusion of Reliability _____	54
7.9	Thorlabs Worldwide Contacts and WEEE Policy _____	55

We aim to develop and produce the best solutions for your applications in the field of optical measurement techniques. To help us to live up to your expectations and constantly improve our products, we need your ideas and suggestions. We and our international partners are looking forward to hearing from you.

Thorlabs GmbH

Warning

Sections marked by this symbol explain dangers that might result in personal injury or death. Always read the associated information carefully, before performing the indicated procedure.

Attention

Paragraphs preceded by this symbol explain hazards that could damage the instrument and the connected equipment or may cause loss of data.

Note

This manual also contains "NOTES" and "HINTS" written in this form.

Please read this advice carefully!

1 General Information

The PM400 Handheld Optical Power and Energy Meter is designed to measure the optical power of laser light or other monochromatic or near monochromatic light sources and the energy of pulsed light sources. Further the PM400 allows to process and display positional information from S44xC Thermal Position Sensors.

Measurements can be controlled either on the device screen or through remote control software. The remote control software Optical Power Monitor (OPM), including drivers and applications for LabVIEW™ and C, makes it easy to integrate the instrument in test and measurement systems. The software package can be downloaded from https://www.thorlabs.com/software_pages/ViewSoftwarePage.cfm?Code=OPM.

The space-saving, battery powered design is compatible with all Thorlabs “C-Series” Photodiode, Thermal Power, and Thermal Position, Pyroelectric sensors, and custom Photodiode, Thermal, and Pyroelectric detectors. Combined with a fast USB device interface, these features open a wide range of applications in Manufacturing, Quality Control, Quality Assurance, and R&D for stationary and field use.

Attention

Please find all safety information and warnings concerning this product in the [Safety](#)⁵² chapter in the Appendix.

1.1 Ordering Codes and Accessories

Ordering Code	Description
PM400	Handheld Power / Energy Meter Console

Included Accessories

- BNC-to-3.5-mm adapter for Analog output
- USB cable A to Mini-B

Optional Accessories

- PM400-PMA post-mount adapter – fix to back with two M3 screws
- PM400-AUX adapter card with GPIO ports and a sensor for ambient temperature and relative humidity measurement.
- TSP-TH external NTC (thermistor temperature sensor)

Please visit our homepage <http://www.thorlabs.com> for various accessories like fiber adapters, posts and post holders, data sheets and further information.

1.2 Requirements

The software Optical Power Monitor (OPM) for remote operation of the PM400 requires PC hardware and software environment as specified on the software [website](#).

2 Getting Started

Please inspect the shipping container for damage. Please do not cut through the cardboard. You might need the box for storage or for returns.

If the shipping container seems to be damaged, inspect the contents for completeness and test the PM400 mechanically and electrically. Keep the container for storage or in order to return the product in case of future problems.

Verify that you have received the following items within the package:

2.1 Parts List

1. PM400 Optical Power Meter Console
2. BNC-to-3.5-mm-Audio Adapter for Analog output
3. USB cable A to Mini-B
4. Quick Reference
5. Certificate of Calibration

3 Operating Instruction

- For first use, connect the PM400 to a suitable [charging device](#)^[21] and charge the battery for 4 hours.
- Connect the optical sensor (C-Series - red DSUB connector) to the [DSUB jack \(4\)](#)^[7] on the top of the device.
- Switch on the PM400.
- The PM400 starts in the last view that was used before shutdown.





3.1 Operating Elements

Front Panel



- 1 Capacitive Touchscreen Area for General Operation
- 2 Battery Charging Indicator
- 3 to 7 Additional Capacitive Touch Buttons for:
 - 3 [Spectral Correction](#)^[14] (enter operating wavelength)
 - 4 Delta mode
 - 5 Zeroing
 - 6 Device Main Menu
 - 7 Return / Reset

The capacitive touch screen allows gesture operation:

-  Click (short) for buttons, drop-downs etc.
-  Horizontal swipe (change view)
-  Horizontal scroll (graph control). Requires two fingers! ¹⁾
-  Zoom (graph control) either with thumb and index or index and middle finger. ¹⁾
-  Press > 2 seconds and release

¹⁾ These gestures are enabled only in the viewer mode of the graph display.

Top Panel

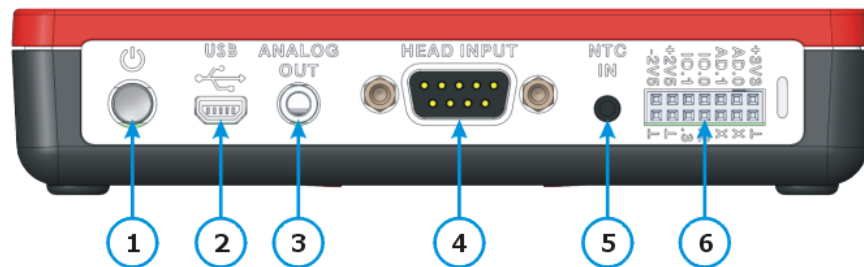

- 1 Device On / Off button
- 2 Mini-B USB connector for remote control, SD card access and charging (Charging via PC @ 0.5 A, charging via adapter @ 1 A)
- 3 Analog Output Signal
2P audio jack Ø 3.5 mm
- 4 9 Pin DSUB for connection of Thorlabs C-Series Power and Energy sensors; Custom detectors
- 5 Connector for External Temperature Sensor TSP-TH (NTC)
3P audio jack Ø 2.5 mm
- 6 Auxiliary connector DIL 14 pin for digital I/O and external environmental module to ambient temperature and humidity.

3.2 Measurement Screens

The PM400 display provides screens to control, display and analyse the measurement.

3.2.1 Needle Screen

Analog needle simulation with digital measurement value. The needle has a factor 10 zooming function. Further, there are indicators for the extreme values that can be set to the actual value by the reset key.

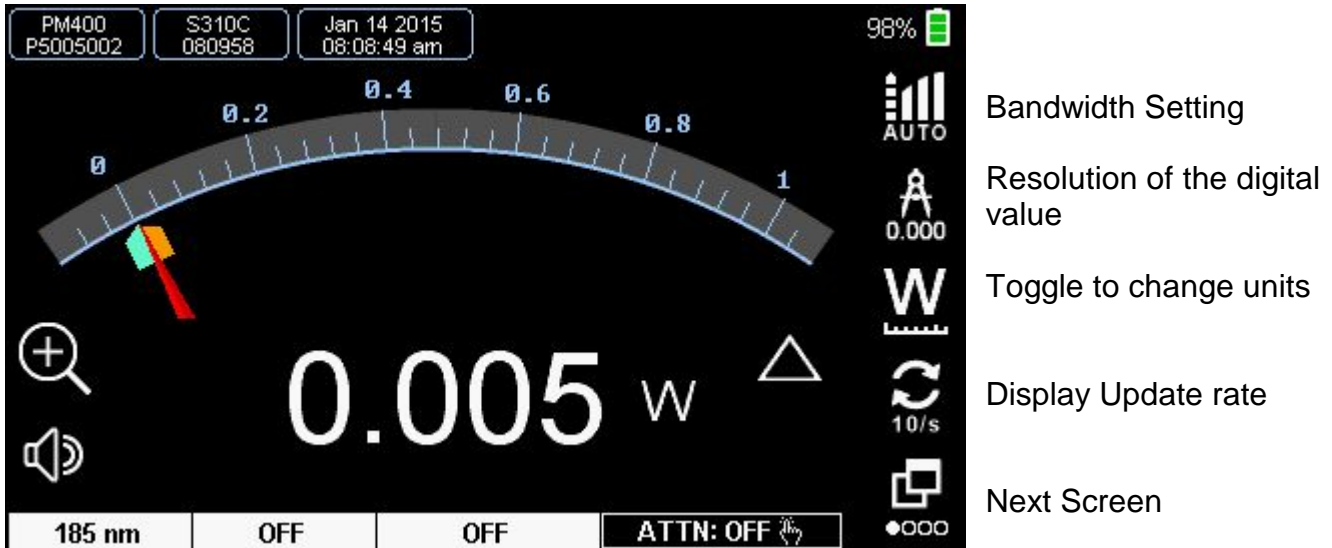

Needle Display - Thermal Sensor ((Zoomed Scale)

The lower display bar shows from left the [set wavelength](#)^[14], status of [Delta](#)^[15] measurement and the [Zero](#)^[15] compensation value.

3.2.2 Numerical Display

Numerical display with bar graph. This view has six additional small configurable displays with additional, sensor specific information.

The sub-display configuration is accessible by drop down menus.

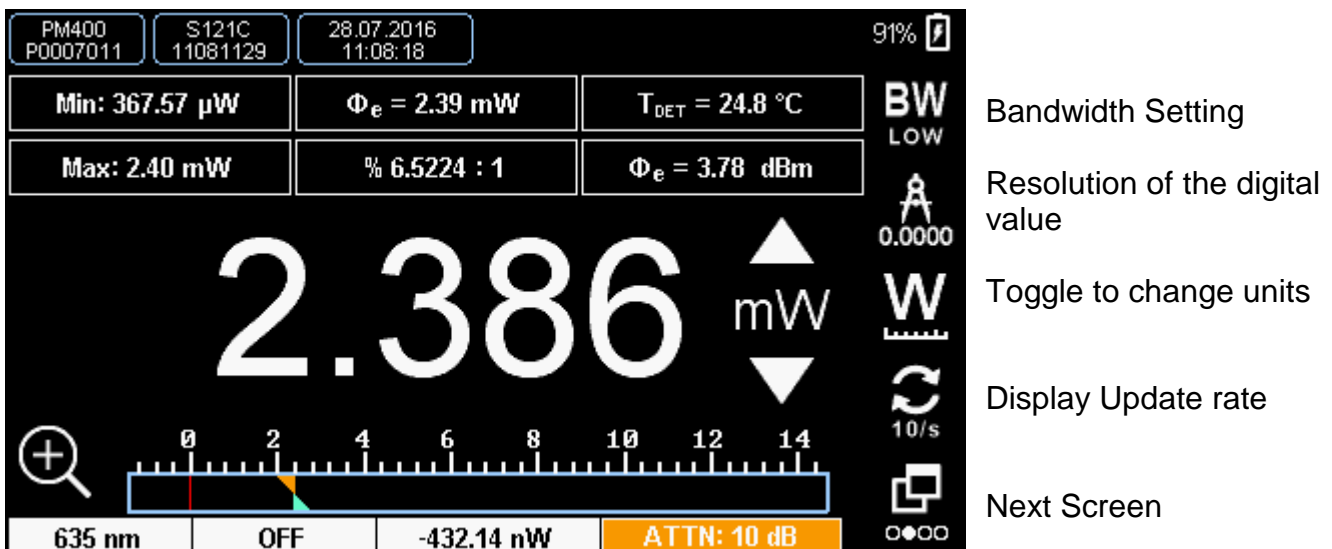

Numeric Display - Photodiode Sensor with External 10 dB Attenuator

The lower display bar shows from left the [set wavelength](#)^[14], status of [Delta](#)^[15] measurement and the [Zero](#)^[15] compensation value.

3.2.3 Graph Display

The graph display allows to capture measurements over time and to analyze the results.

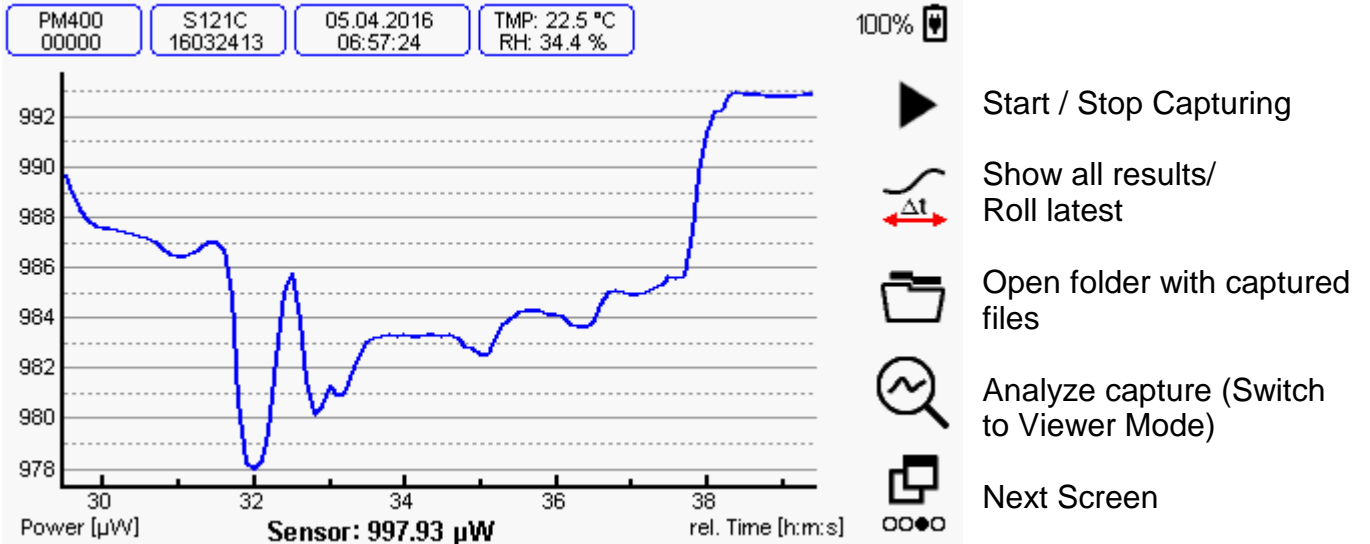

Graph Display in Capturing Mode

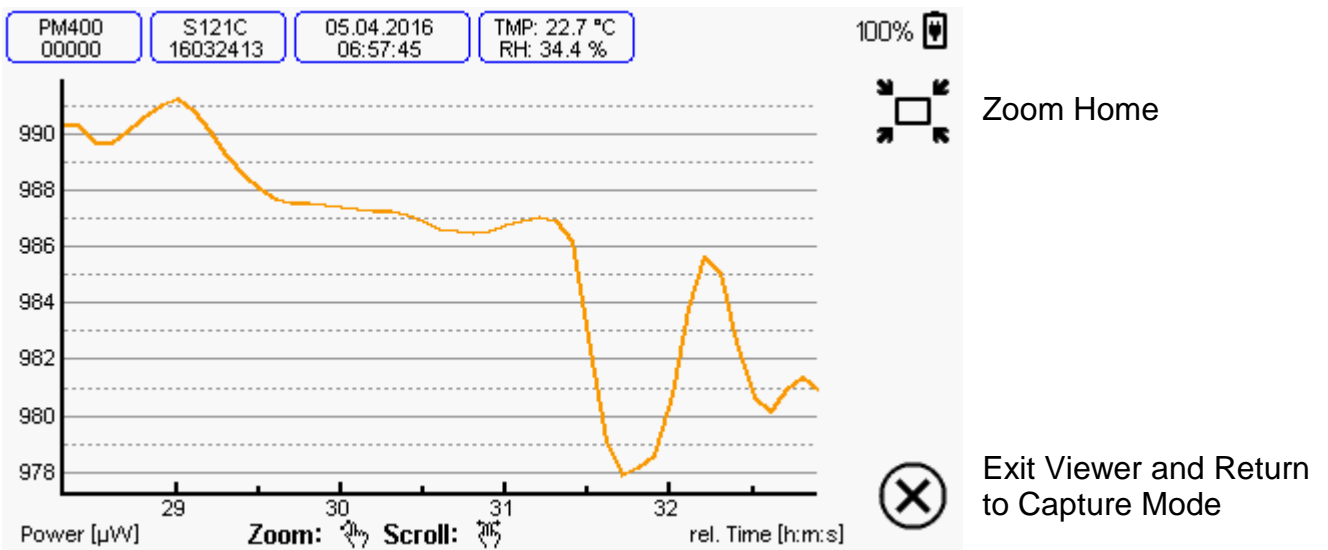

Graph Display in Viewer Mode

3.2.4 Statistics Display

In the Statistics Display a sequential measurement can be started. The display then shows typical statistic values over the expired time / samples.

PM400 00000 S121C 16032413 05.04.2016 06:57:59 TMP: 22.7 °C RH: 34.5 % 100%

Actual: 970.56 μ W

Minimum: 856.61 μ W
 Maximum: 993.00 μ W
 Mean: 978.66 μ W
 Standard Deviation: 14.00 μ W
 Ratio: 1.1592 : 1

Samples: 392 Time: 39 [h:m:s] Int.: 100 ms

Start / Stop Sampling

Next Screen

Statistics Display

3.2.5 Positional Measurement with Sensors S44xC

The PM400 can analyze and display data for positional measurements using Thorlabs Thermal Sensors for position measurements, S440C or S442C.

When either sensor is connected, the PM400 will start with the following screen.

Position Display

The target circle represents the positional readout of the four quadrants. The target area can be adjusted to show with a 1 mm or 6 mm diameter of the target area by tapping on the target on the screen. The left side shows the power, as measured over the entire sensor surface, and the positional information in X and Y values.

In addition to the target display, numerical, graph and statistics display are available by selecting "next screen" on the bottom right corner.

PM400 P5000607 S440C 1902186 Nov 18 2019 09:54:30 am 58%

54.58 mW

x: -0.125mm
 y: 0.180mm

Resolution of the digital value: 0.0000
[Toggle to change units](#)^[12]

Display Update rate: 10/s

Position Trace over time

Next Screen

1064 nm OFF OFF ATTN: OFF

Position Display - Thermal Sensor

The lower display bar shows from left the [set wavelength](#)^[14], status of [Delta](#)^[15] measurement, the [Zero](#)^[15] compensation value, [attenuation correction](#)^[16].

Position Trace display

When selecting the trace icon to the right, the detected position of the beam is displayed as a trace over time as shown below.

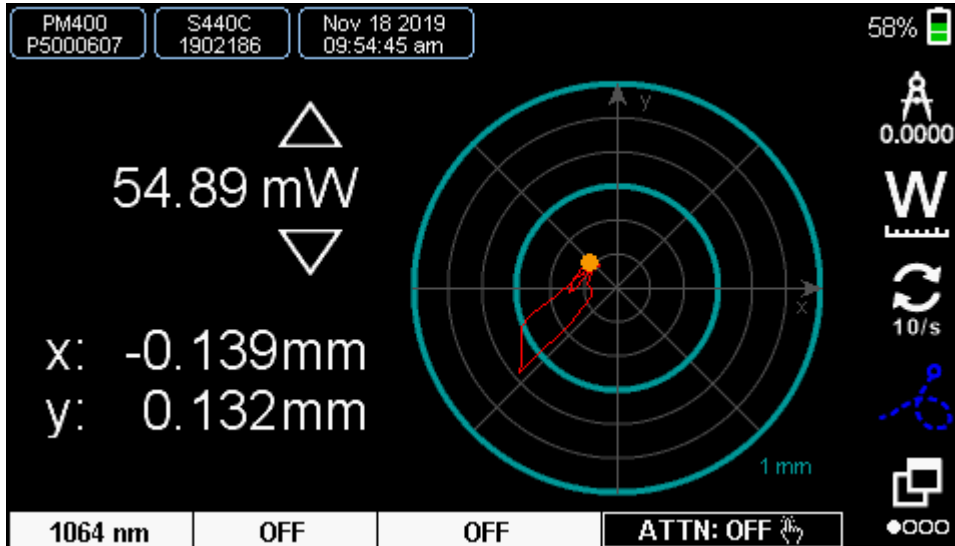

Numerical display

Show the power as the overall value for the entire sensor.

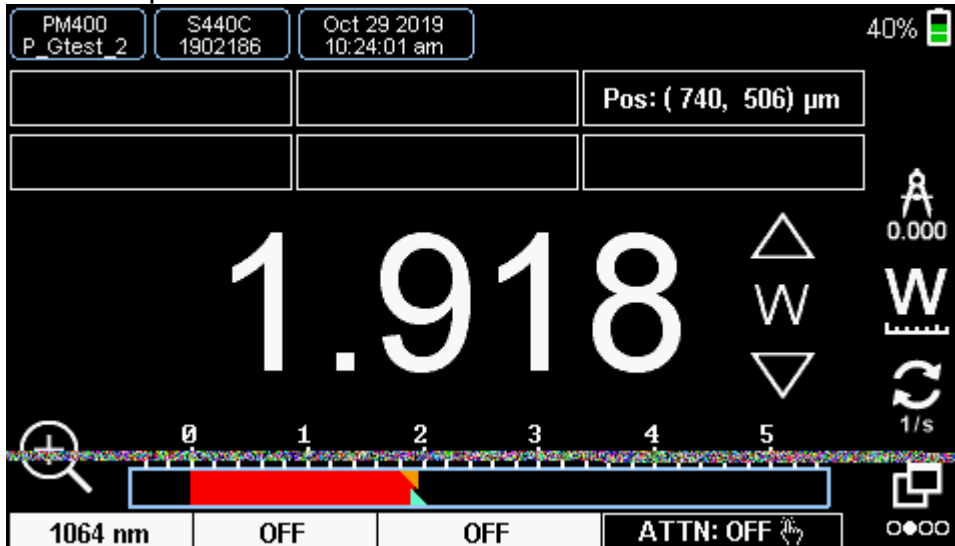

- Display of position coordinates
- Resolution of the digital value
- Toggle to change units to W, V, or dB
- Display Update rate
- Next Screen

Graph display

This display shows either the position over time as shown here in X (blue) and Y (orange), or the intensity trace over time as described in the chapter [Graph Display](#) above. To switch between the two displays, use the beam icon or target icon, respectively, on the right.

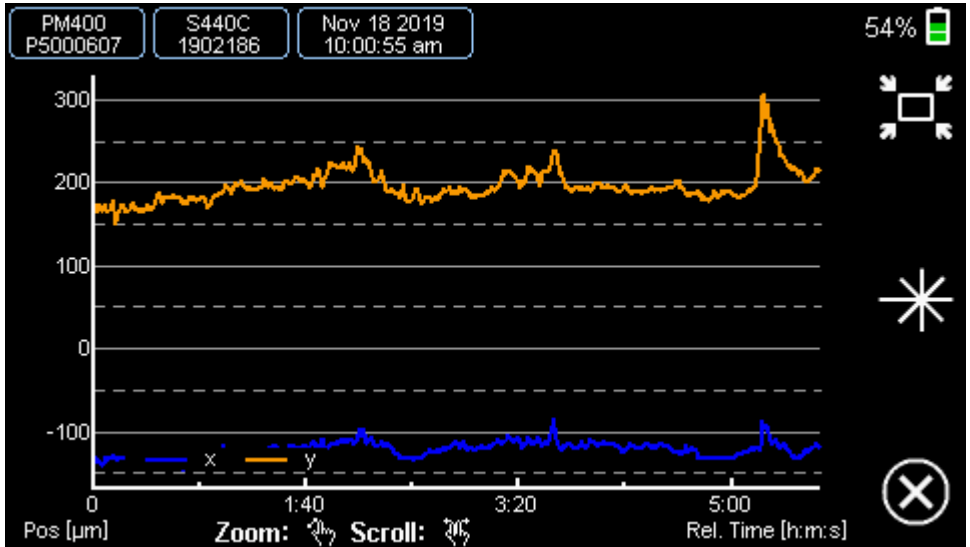

Switch between intensity and positional information

Next Screen

Statistics display

In the Statistics Display a sequential measurement can be started. The display then shows typical statistic values over the expired time / samples.

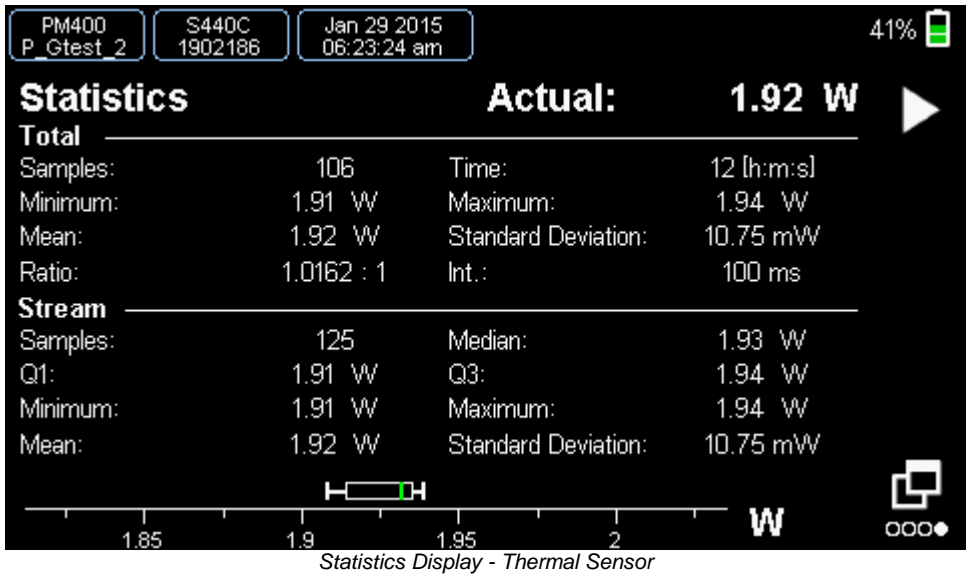

Start Recording

Next Screen

3.3 Measurement Configuration

Ranging

The PM400 can be operated in AUTO and MANUAL ranging mode.



Tap on the measurement unit ("mW") to toggle between AUTO and MANUAL ranging. When AUTO is enabled, the arrows are shown in outlines.



To switch from AUTO to manual, either tap on the measurement unit ("mW") or on one of the arrows. When MANUAL is enabled, the arrows are shown filled.

Sensor Specific Settings

BW

LOW



Depending on the detected sensor, the icon in the upper right corner allows to set specific features: Bandwidth setting (Photodiode sensors), Acceleration setting (Thermal sensors) and Trigger level (Pyro-electric Energy sensors)

Resolution of the Numeric Measurement Results



The Display Resolution can be set to 3, 4 or 5 significant digits.

Measurement Units



Toggles between linear and logarithmic representation of the measurement results.

Display Update Rate



The Display Update Rate can be set to 10, 3 or 1 update per second.

3.4 Spectral Correction

Press the λ button to enter the spectral correction menu.

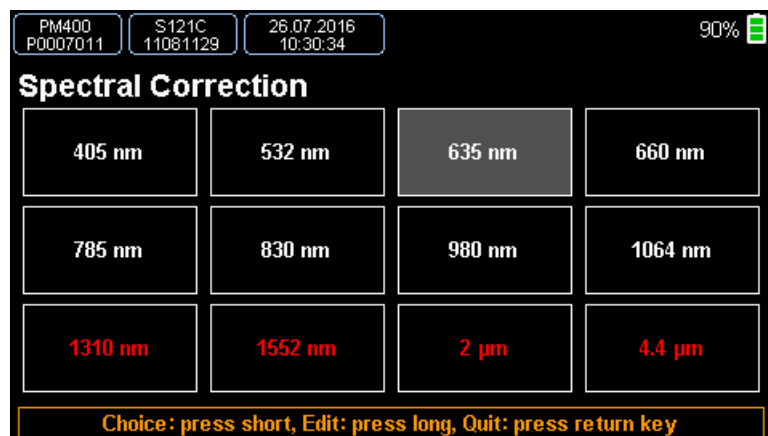

This menu contains 12 entries, all of them are configurable. To edit an entry, press and hold it for ~ 2 sec. The edit window comes up:

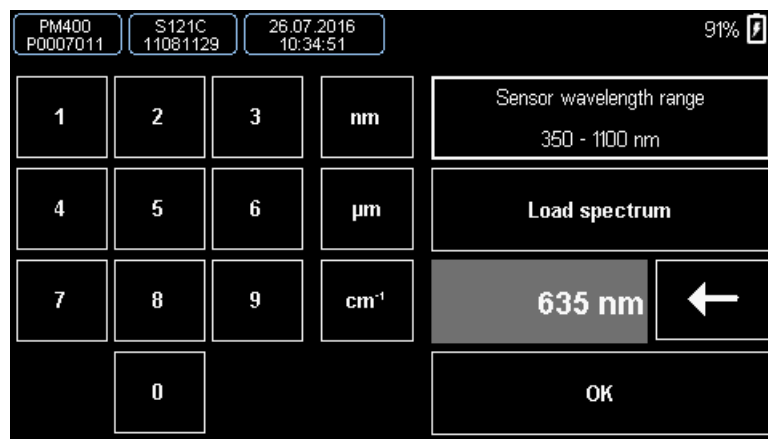

Now you can create an entry in either nanometers, micrometers or wavenumber or to load a light spectrum curve in .csv format. Confirm and chose your entry

The actual wavelength setting value displays in the field above the λ button in Needle and Numerical measurement screens.

3.5 Delta Mode

Press the  button to enter the Delta Mode. The actual measurement value is set to zero, saved as reference and the difference to the reference value. is displayed. The reference value displays in the field above the operating button.

The scale-based indicators go to a middle setting.

3.6 Zeroing

Press the  button to enter the Zeroing menu. Follow the displayed instructions.

After successful Zeroing, the Zero value is displayed in the field above the  button in Needle and Numerical measurement screens.

3.7 Attenuation Correction

In order to take into account the attenuation of external devices (e.g. filter, beam splitter) to the displayed measurement value, a correction factor can be assigned.

To enter the menu for the filter correction, press the ATTN button in the Numerical or Needle screen:

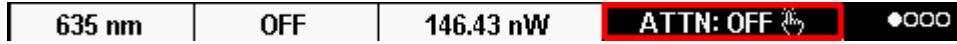

A page with 12 free configurable presets comes up:

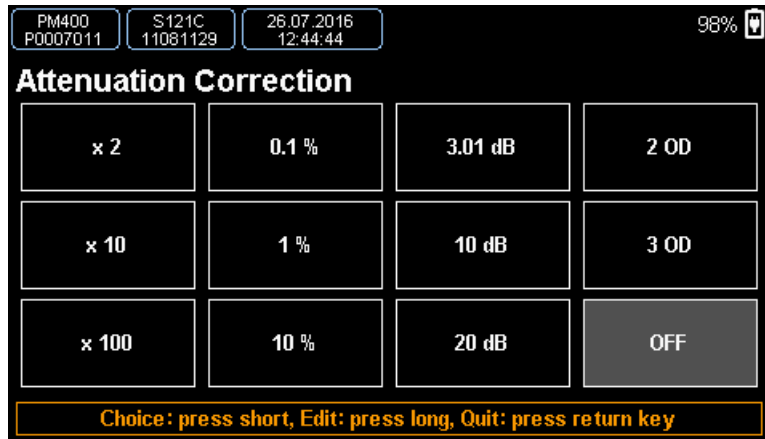

The attenuation can be assigned in "times" (e.g., "x2"), in percent, dB or in OD (optical density) numbers. To edit an entry, press and hold it for ~2 seconds.

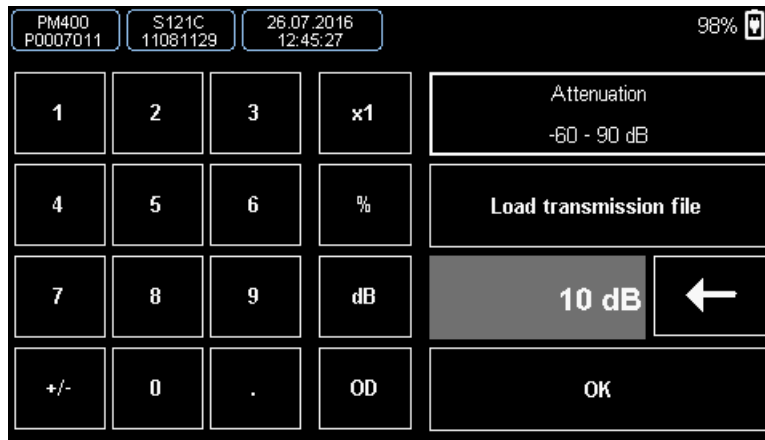

In this configuration window you can create an entry for an external filter etc. Further, there is the possibility to load a complete filter transmission curve in .csv format. Press OK to confirm. Then tap the edited entry to activate it. With active correction, the button displays in a different color and shows the set value:





To disable the correction press and hold the ATTN button for 2 seconds, or chose an entry with "OFF".





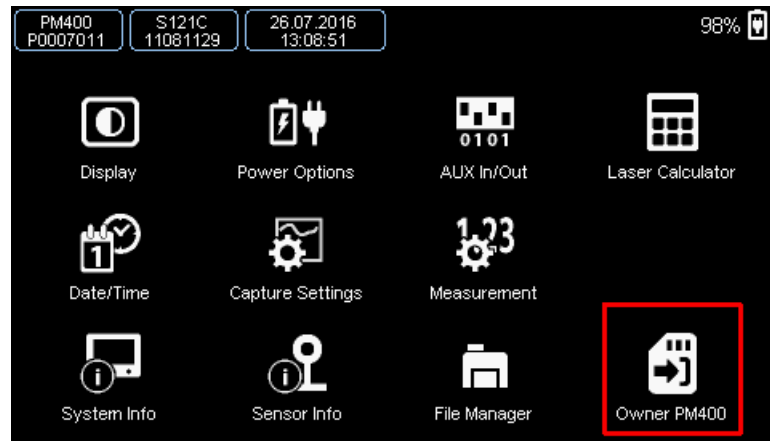

3.8 Data Handling

The PM400 has an internal 4 GB flash memory that holds captured measurement data, specific correction, and language files. This internal memory is allocated by default to the system.

For accessing or modifying these data externally, and adding or removing files, the memory can be mounted to a USB link to a PC. Therefore, call the system menu and tap the icon "Owner PM400".



The icon changes to "Owner USB" and an additional red 'memory card' icon  appears in the header bar. The connected PC recognizes the PM400 memory as a "Removable Disk" that can be accessed from the Windows explorer:

Name	
 ATTEN_CURVES	→ Transmission curves of external filters (csv: wavelength, transmission)
 LANG	→ Translation files for language setting (UTF-8 w/o BOM: special format)
 RECORD	→ Capturing files (csv: relative time, level)
 SCRSHOT	→ Screenshot images (bmp)
 SPEC_CURVES	→ Spectral curves of light sources (csv: wavelength, relative Intensity)
 SUPPORT_DOCS	→ Support document files and Software

This memory also contains the device manuals, drivers and applications.

3.9 Subpanels

In the Numerical screen, 6 subpanels can be configured in order to display additional results:

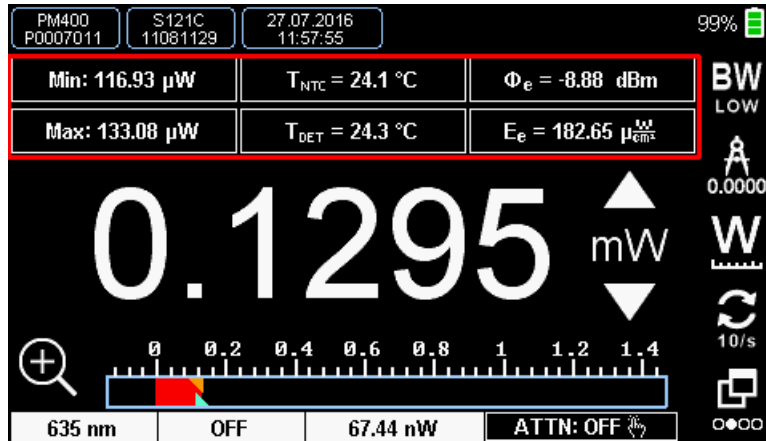

To configure a subpanel, tap to it and select from the drop-down list the desired parameter. Please note, that additional parameters are sensor-dependent, as stated in the table below:

Photodiode Sensors	Thermal Sensors	Pyro-Electric Sensors
----- (none)	----- (none)	----- (none)
Current	Voltage	Voltage
Power Φ_e	Power Φ_e	Energy W_{DET}
Power Φ_e dBm	Power Φ_e dBm	(not available)
Max	Max	Max
Min	Min	Min
Ratio (Max/Min)	Ratio (Max/Min)	Ratio (Max/Min)
Sensor Temperature ¹⁾	Sensor Temperature ¹⁾	(not available)
Frequency	Frequency	Frequency
Ext. NTC Temperature	Ext. NTC Temperature	Ext. NTC Temperature
Irradiance E_e	Irradiance E_e	Fluence H_e

¹⁾ - Available only if a sensor-internal temperature sensor is detected.

3.10 Main Menu

Pressing the  button, opens the PM400 Main Menu.

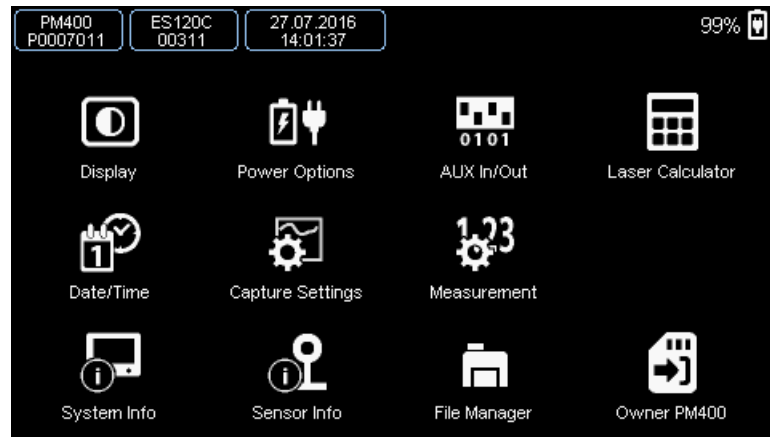

Submenu **Display**

- Display brightness
- Skin (dark or light)
- Language (English, German, Chinese or French)
- Enable / disable button sound
- Lock / unlock GUI control; in Remote operation: performs GTL (Go To Local) command

Submenu **Power Options**

- Dim Backlight and Auto-Shutdown on battery and mains operation
- Battery state information

Submenu **AUX IN / Out**

- Enable / Disable GPIO ports

Submenu **Laser Calculator**

- Submenu **Laser Calculator**: Allows entering beam parameters for correct calculation of the additional parameters
- Submenu **Unit Converter**: Allows optical power conversion between W and dBm, wavelength conversion between wavelength, frequency, wave numbers and photon energy.

Submenu **Date / Time**

- Set date and time

Submenu **Capture Settings**

- Set long-time capture parameters: capture control (manual, time, number of samples) and capture interval (10 ms to 60 s)
- Optional temperature logging
- Returns estimated output file size

Submenu **Measurement**

- Sensor-dependent content
- Adjust common settings (mode, wavelength, attenuation, displayed measurement units, ranging, display resolution and update rate, etc.)
- Enter beam parameters (shape, type and diameter)
- Adjust settings of the sensor-internal temperature sensor
- Select type of custom sensor, if used

Submenu **System Info**

Submenu **Sensor Info**

Submenu **File Manager**

- Manage files in the Flash memory

Button **Memory Owner**

- Assign the Flash memory access between PM400 or a connected via USB PC

3.11 Charging the Battery

The PM400 can be charged

- by connecting it to a PC USB port. In this case, the internal charging circuit enters the "Slow Charge" mode at a max. current of 500 mA, as it usually delivered by a PC Standard USB port.
- by connecting it to a wall-plug charger as it comes with smart phones, tablets etc. These chargers have a so called "Dedicated Charging Port". In this case, the PM400 enters the high current charging mode, with a maximum current of 1 A.

With a connected PC or charger, the [Battery Charging Indicator](#)^[6] displays the charging status:

- Red: The battery is charging.
- Green: The battery is fully charged. Remove the charger under environmental aspects.
- Red blinking: The connected charger is not compatible with the Dedicated Charging Port specification. The battery is charged only with a current of about 100 mA.

3.12 Analog and Auxiliary I/O

Analog Out

The [Analog Output jack](#)^[7] provides the amplified photo-diode current or the amplified thermal or pyroelectric sensor voltage. The signals from the analog output are not wavelength- and zero-corrected. The analog output voltage can range from 0 to +2.0V. It is is measurement range dependent and can be calculated to:

$$U_{\text{out}} = 2 \text{ V} \times \frac{\text{Measured Value}}{\text{Full Scale Value}}$$

Auxiliary I/O

This 14 pin connector in the top panel gives access to four configurable general purpose input/output (GPIO) pins and two 10bit ADC inputs.

With the optional available environmental module that can be plugged into this connector it is possible to monitor the room temperature and the relative humidity.

4 Computer Interface

The PM400 optical power meter contains a USB 2.0 interface for remote control of the unit by an external PC. Connect the unit via the Mini-USB connector in the top panel to a free USB port of your PC.

When connecting the PM400 first time, a new hardware will be found.

4.1 Software Optical Power Monitor

The Thorlabs [Optical Power Monitor](#) (OPM) software provides a Graphical User Interface to view, log, and analyze measurement data. Download the OPM software package from the Thorlabs website, via this [link](#), through the software tab on the product website, or through searching for the product name within the Thorlabs [software website](#).

All information on software installation, device control and data management software can be found in the software manual directly downloaded [here](#).

Note

Do not connect the PM400 prior to software installation!

Attention

Exit all running applications on your PC as the installer may require a reboot of your PC during installation!

Custom Made Software

The PM400 can also be run using custom made software. For this, please refer to the document Write-Your-Own-Application (WYOA) for PM400.

Software Requirements

The software Optical Power Monitor (OPM) for remote operation of the PM400 requires a PC hardware and software environment as specified on the software [website](#).

4.2 Using the Instrument Drivers

Instrument Driver Installation

The PM400 software package contains a set of instrument drivers that allows convenient remote controlling the instrument in most common programming languages. The instrument drivers must be installed, please follow the setup dialog instructions.

Note

To successfully complete the install of the PM400 USB driver you must have Administrator privileges on the PC which you are performing the install.

After successfully installing the drivers connect the PM400 to a USB port of your PC. The PC will find a PM400 test and measurement device. Please follow the instructions of the dialog screens and allow the installation.

Instrument Driver Example

The following LabVIEW™ example demonstrates how to use the instrument drivers for measurement tasks. The example is included on the data carrier that came with the instrument.

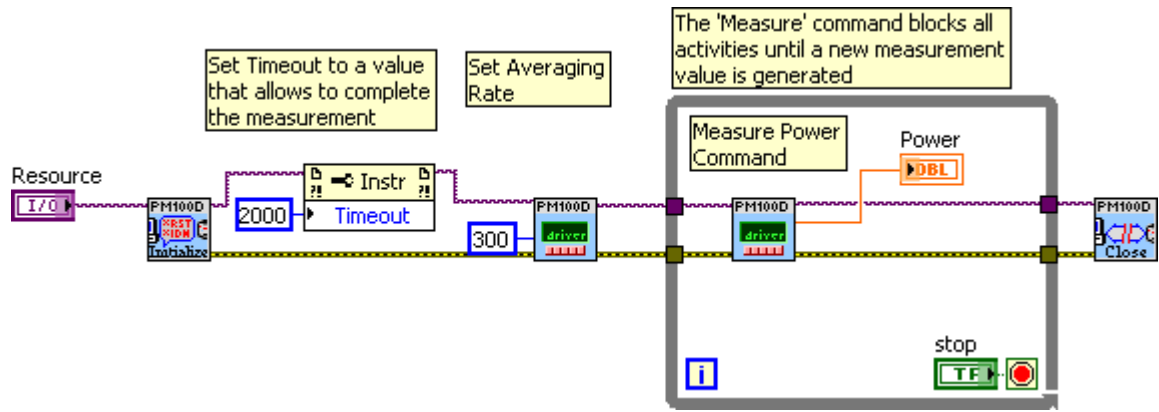

5 Write Your Own Application

In order to write your own application, you need a specific instrument driver and some tools for use in different programming environments. The driver and tools are included in the installer package and cannot be found as separate files on the installation CD.

In this section the location of drivers and files, required for programming in different environments, are given for installation under Windows XP (32 bit) and Windows 7 (32 and 64 bit)

Note

PM400 software and drivers contains 32 bit and 64 bit applications.

In 32 bit systems, only the 32 bit components are installed to

`C:\Program Files\...`

In 64 bit systems the 64 bit components are being installed to

`C:\Program Files\...`

while 32 bit components can be found at

`C:\Program Files (x86)\...`

In the table below you will find a summary of what files you need for particular programming environments.

Programming environment	Necessary files
C, C++, CVI	*.fp (function panel file; CVI IDE only) *.h (header file) *.lib (static library) *.dll (dynamic linked library)
C#	.net wrapper dll
Visual Studio	*.h (header file) *.lib (static library) or .net wrapper dll
LabView	*.fp (function panel) and NI VISA instrument driver Beside that, LabVIEW driver vi's are provided with the *.llb container file

Note

All above environments require also the NI VISA instrument driver dll !

During NI-VISA Runtime installation, a system environment variable `VXIPNPPATH` for including files is created. It contains the information where the drivers are installed to, usually to `C:\Program Files\IVI Foundation\VISA\WinNT\`.

This is the reason, why after installation of a NI-VISA Runtime a system reboot is required: This environment variable is necessary for installation of the instrument driver software components.

In the next sections the location of above files is described in detail.

5.1 Windows XP 32bit

NI VISA Instrument Driver 32bit

C:\Program Files\IVI Foundation\VISA\WinNT\Bin\PM100D_32.dll

Online Help for NI VISA Instrument Driver

C:\Program Files\IVI Foundation\VISA\WinNT\PM100D\Manual\PM100D.html

NI LabVIEW Driver

The LabVIEW version of this driver was generated with the "NI LabVIEW Instrument Driver Import Wizard 2.0" in conjunction with LabVIEW 2011.

C:\Program Files\IVI Foundation\VISA\WinNT\PM100D\LabVIEW\PM100D.llb

Header File

C:\Program Files\IVI Foundation\VISA\WinNT\include\PM100D.h

Static Library

C:\Program Files\IVI Foundation\VISA\WinNT\lib\msc\PM100D_32.lib

Function Panel

C:\Program Files\IVI Foundation\VISA\WinNT\PM100D\PM100D.fp

.net wrapper dll

C:\Program Files\IVI Foundation\VISA\VisaCom\...
...Primary Interop Assemblies\Thorlabs.PM100D.dll

C:\Program Files\IVI Foundation\VISA\WinNT\PM100D\DotNet\...
...Thorlabs.PM100D.dll

C:\Program Files\Microsoft.NET\Primary Interop Assemblies\...
...Thorlabs.PM100D.dll

Examples

ANSI-C

C:\Program Files\IVI Foundation\VISA\WinNT\PM100D\Samples\C\sample.c

Thorlabs PM100x/PM160/PM200 Instrument Driver Sample Application with console interface. Read the comment text in the sample.c file for more information.

C# Visual Studio 2010

C:\Program Files\IVI Foundation\VISA\WinNT\PM100D\Samples\...
...DotNet\DotNetSample.csproj

Very basic C# sample project. The application opens a session to a device takes one measurement and closes the device again.

5.2 Windows Vista / 7 / 8 - 32bit

NI VISA Instrument Driver

C:\Program Files\IVI Foundation\VISA\WinNT\Bin\PM100D_32.dll

Online Help for NI VISA Instrument Driver:

C:\Program Files\IVI Foundation\VISA\WinNT\PM100D\Manual\PM100D.html

NI LabVIEW Driver

The LabVIEW version of this driver was generated with the "NI LabVIEW Instrument Driver Import Wizard 2.0" in conjunction with LabVIEW 2011.

C:\Program Files\IVI Foundation\VISA\WinNT\PM100D\LabVIEW\PM100D.llb

Header File

C:\Program Files\IVI Foundation\VISA\WinNT\include\PM100D.h

Static Library

C:\Program Files\IVI Foundation\VISA\WinNT\lib\msc\PM100D_32.lib

Function Panel

C:\Program Files\IVI Foundation\VISA\WinNT\PM100D\PM100D.fp

.net wrapper dll

C:\Program Files\IVI Foundation\VISA\VisaCom\...
...Primary Interop Assemblies\Thorlabs.PM100D.dll

C:\Program Files\IVI Foundation\VISA\WinNT\PM100D\DotNet\...
...Thorlabs.PM100D.dll

C:\Program Files\Microsoft.NET\Primary Interop Assemblies\...
...Thorlabs.PM100D.dll

Examples:

ANSI-C

C:\Program Files\IVI Foundation\VISA\WinNT\PM100D\Samples\C\sample.c

Thorlabs PM100x/PM160/PM200 Driver Sample Application with console interface. Read the comment text in the sample.c file for more information.

C# Visual Studio 2010

C:\Program Files\IVI Foundation\VISA\WinNT\PM100D\Samples\...
...DotNet\DotNetSample.csproj

Very basic C# sample project. The application opens a session to a device takes one measurement and closes the device again.

5.3 Windows Vista / 7 / 8 - 64bit

NI VISA Instrument Driver 32bit

C:\Program Files (x86)\IVI Foundation\VISA\WinNT\Bin\PM100D_32.dll

NI VISA Instrument Driver 64bit

C:\Program Files\IVI Foundation\VISA\Win64\Bin\PM100D_64.dll

Online Help for NI VISA Instrument Driver

C:\Program Files\IVI Foundation\VISA\Win64\PM100D\Manual\PM100D.html

NI LabVIEW Driver 32bit

C:\Program Files (x86)\IVI Foundation\VISA\WinNT\PM100D\...
...LabVIEW\PM100D.llb

NI LabVIEW Driver 64bit

C:\Program Files\IVI Foundation\VISA\Win64\PM100D\LabVIEW\PM100D.llb

Header File 32bit

C:\Program Files (x86)\IVI Foundation\VISA\WinNT\include\PM100D.h

Header File 64bit

C:\Program Files\IVI Foundation\VISA\Win64\include\PM100D.h

Static Library 32bit

C:\Program Files (x86)\IVI Foundation\VISA\WinNT\lib\msc\PM100D_32.lib

Static Library 64bit

C:\Program Files\IVI Foundation\VISA\Win64\Lib_x64\msc\PM100D_64.lib

Function Panel 32bit

C:\Program Files (x86)\IVI Foundation\VISA\WinNT\PM100D\PM100D.fp

Function Panel 64bit

C:\Program Files\IVI Foundation\VISA\Win64\PM100D\PM100D.fp

.net wrapper dll 32bit

```
C:\Program Files (x86)\IVI Foundation\VISA\VisaCom\...  
...Primary Interop Assemblies\Thorlabs.PM100D.dll  
C:\Program Files (x86)\Microsoft.NET\Primary Interop Assemblies\...  
...Thorlabs.PM100D.dll
```

.net wrapper dll 64bit

```
C:\Program Files\IVI Foundation\VISA\VisaCom64\...  
...Primary Interop Assemblies\Thorlabs.PM100D.dll
```

Examples:

ANSI-C

```
C:\Program Files\IVI Foundation\VISA\Win64\PM100D\Samples\C\sample.c
```

Thorlabs PM100x/PM160/PM200 Driver Sample Application with console interface. Read the comment text in the sample.c file for more information.

C# Visual Studio 2010

```
C:\Program Files\IVI Foundation\VISA\Win64\PM100D\Samples\DotNet\...  
...DotNetSample_64.csproj
```

Very basic C# sample project. The application opens a session to a device takes one measurement and closes the device again.

5.4 Simple LabVIEW Example using SCPI commands

The PM400 Instrument driver is not required for this LabVIEW example.



PM100D Simple Example.vi

This VI shows how to communicate with a PM400 optical power/energy meter with SCPI commands. The following steps are demonstrated within this application:

- Initializing the instrument
- Getting system info
- Setting parameters
- Measurement configuration
- Measuring queue
- Fetching and displaying a measurement value
- Closing the application

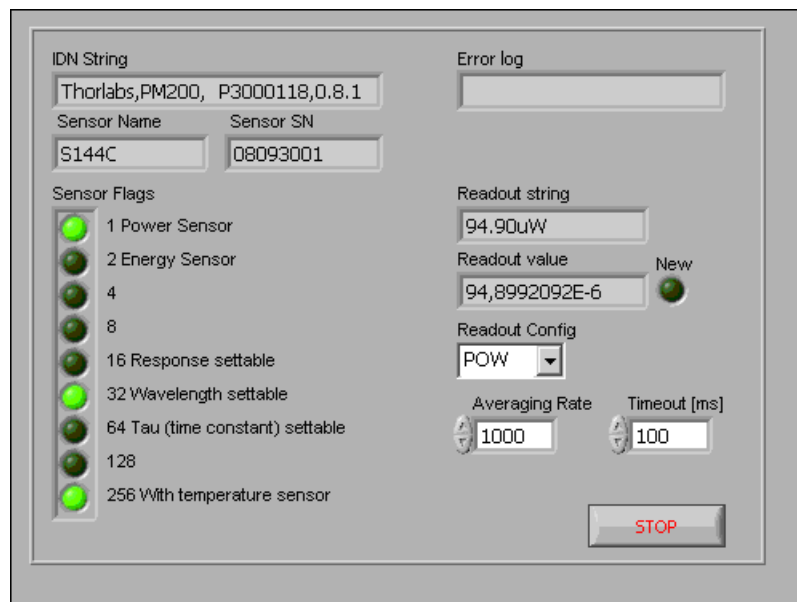

Block Diagram

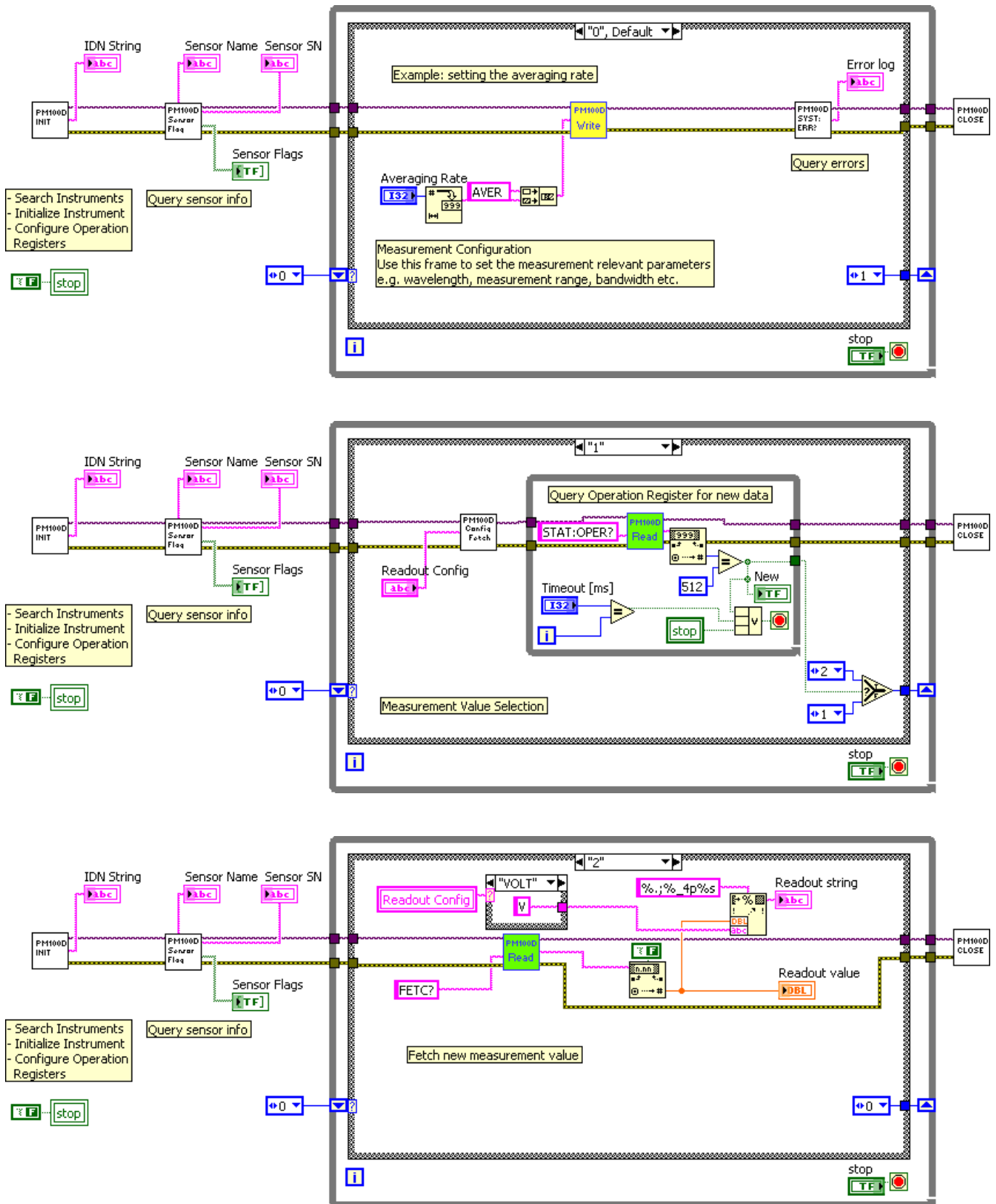



Averaging Rate

Sets the averaging rate - 3000 averages take approximately 1s for performing a new measurement value



Readout Config

Selects the measurement parameter

- POW power measurement in W
- CURR current measurement in A
- VOLT voltage measurement in V
- ENER energy measurement in J
- FREQ frequency / repetition rate measurement in Hz
- PDEN power density measurement in W/cm²
- EDEN energy density measurement in J/cm²
- RES thermistor resistance measurement in Ohm
- TEMP temperature measurement in °C



Stop

Stops application



Timeout [ms]

Sets a timeout value in ms that allows the instrument to sample.

The timeout must be longer than it takes to perform a new measurement. This has especially to be considered when performing single shot energy measurements.



Error log

Error indicator, 'no error' is suppressed



Readout string

Formatted measurement value

- limitation to 4 significant digits
- SI notation
- '.' decimal separator
- appended unit according readout configuration



New

Indicator lights up, when a new measurement value is processed



Sensor Flags



Sensor flag bitmap:

- 1 Is power sensor
- 2 Is energy sensor
- 16 Response settable
- 32 Wavelength settable
- 64 Tau settable
- 256 Has temperature sensor



Sensor Name

Name of connected power/energy sensor



Sensor SN

Serial number of connected power/energy sensor

**IDN String**

Answer from instrument on *idn? command:

- manufacturer
- model number
- serial number
- firmware version

**Readout value**

Plain readout value in full resolution

**PM100D_Initialize.vi**

This VI scans for connected devices, that can be selected in a dialog box. Next steps

- setting timeout
- performing identification query
- configuring the operation register to '512'; flag gets to HI when a new measurement value is ready to fetch
- clear operation register

**PM100D_Write.vi**

Writes a SCPI command to the connected instrument

**PM100D_Read.vi**

Reads data from the connected instrument. All query commands according the SCPI command table are terminated by a question mark (?)

**PM100D_SensorFlag.vi**

This VI queries all relevant sensor info with SYST:SENS:IDN?

- sensor name
- sensor serial number
- calibration message
- sensor type
- sensor sub-type
- sensor flags

**PM100D_ConfMeas.vi**

- CONFigure measurement; CONF:<parameter> (POW, ENER, etc.)
- ABORt measurement
- Clear operation register with STAT:OPER?
- INITiate measurement

**PM100D_SYST-ERR.vi**

This VI lists all errors coming from the instrument with the command SYST:ERR?

'no error' is suppressed

**PM100D_Close.vi**

Closes the VISA session

Sets the connected instrument in local mode (default option)

5.5 SCPI Commands

This section describes in detail the SCPI command set with respect to PM400 power meter console. However, these commands are compatible with PM100A, PM100D and PM100USB consoles as well as with the PM160 Hand-held Power Meter, except some console and sensor related functions.

5.5.1 An Introduction to the SCPI language

The PM400 interface commands use the SCPI (Standard Commands for Programmable Instruments), an ASCII-based command language that was designed for test and measurement instruments.

SCPI commands are based on a hierarchical structure, also known as a tree system. In this system, associated commands are grouped together under a common node or root, thus forming subsystems. A portion of the SENSE subsystem is shown below to illustrate the tree system.

SENSE:

```

CORRection
  :COLLect
    :ZERO
      [:INITiate]
      :ABORt
      :STATe?
      :MAGNitude?
    :BEAMdiameter {MINimum|MAXimum|DEFault|<numeric_value>[mm]}
    :BEAMdiameter? [{MINimum|MAXimum|DEFault}]
    :WAVelength {MINimum|MAXimum|<numeric_value>[nm]}
    :WAVelength? [{MINimum|MAXimum}]
    :POWER
      [:PDIode]
      [:RESPonse] MINimum|MAXimum|DEFault|<numeric_value>[A]}
      [:RESPonse]? [{MINimum|MAXimum|DEFault}]
    :THERmopile
      [:RESPonse] {MINimum|MAXimum|DEFault|<numeric_value>[V]}
      [:RESPonse]? [{MINimum|MAXimum|DEFault}]

```

SENSE is the root keyword of the command, CORRection is the second-level keyword, and COLLECT and BEAMdiameter are third-level keywords, and so on.

A colon (:) separates a command keyword from a lower-level keyword.

Command Format

The format used to show commands in this manual is shown below:

```

CURRent[:DC]:RANGE {MINimum|MAXimum|<numeric_value>[A]}
CORRection:BEAMdiameter {MINimum|MAXimum|DEFault|<numeric_value>[mm]}

```

The command syntax shows most commands (and some parameters) as a mixture of upper- and lower-case letters. The upper-case letters indicate the abbreviated spelling for the command. For shorter program lines, send the abbreviated form. For better program readability, send the long form.

For example, in the above syntax statement, CURR and CURRENT are both acceptable forms. You can use upper- or lower-case letters. Therefore, CURRENT, current and Current are all acceptable. Other forms, such as CUR and CURREN, will generate an error.

Braces ({ }) enclose the parameter choices for a given command string. The braces are not sent with the command string. A *vertical bar* (|) separates multiple parameter choices for a given command string.

Triangle brackets (< >) indicate that you must specify a value for the enclosed parameter. For example, the above syntax statement shows the *range* parameter enclosed in triangle brackets. The brackets are not sent with the command string. You must specify a value for the parameter (such as "CURR:DC:RANG 50E-6").

Some parameters are enclosed in *square brackets* ([]). The brackets indicate that the parameter is optional and can be omitted. The brackets are not sent with the command string. In this example [:DC] can be omitted, so the command string can be shortened to "CURR:RANG 50E-6". If you do not specify a value for an optional parameter, the power/energy meter chooses a default value.

Command Separators

A *colon* (:) is used to separate a command keyword from a lower-level keyword. You must insert a *blank space* to separate a parameter from a command keyword. If a command requires more than one parameter, you must separate adjacent parameters using a *comma* as shown below:

```
"SYST:TIME 10, 34, 48"
```

A *semicolon* (;) is used to separate commands within the *same* subsystem, and can also minimize typing. For example, sending the following command string:

```
"CORR:BEAM 1; WAV 1310"
```

... is the same as sending the following two commands:

```
"CORR:BEAM 1"  
"CORR:WAV 1310"
```

Use a colon and a semicolon to link commands from different subsystems. For example, in the following command string, an error is generated if you do not use both the colon and semicolon:

```
"CORR:BEAM 1;:AVER 300"
```

Using the *MIN* and *MAX* Parameters

You can substitute *MINimum* or *MAXimum* in place of a parameter for many commands. For example, consider the following command:

```
CURRent[:DC]:RANGe {MINimum|MAXimum|<numeric_value>[A]}
```

Instead of selecting a specific current range, you can substitute *MIN* to set the range to its minimum value or *MAX* to set the range to its maximum value.

Querying Parameter Settings

You can query the current value of most parameters by adding a question mark (?) to the command. For example, the following command sets the operating wavelength to 1550 nm:

```
"CORR:WAV 1550"
```

You can query the operating wavelength by executing: "CORR:WAV?". You can also query the minimum or maximum operating wavelength allowed as follows:

```
"CORR:WAV? MIN"  
"CORR:WAV? MAX"
```

Caution

If you send two query commands without reading the response from the first, and then attempt to read the second response, you may receive some data from the first response followed by the complete second response. To avoid this, do not send a query command without reading

the response. When you cannot avoid this situation, send a device clear before sending the second query command.

SCPI Command Terminators

A command string sent to the power/energy meter must terminate with a <new line> character. The IEEE-488 EOI (end-or-identify) message is interpreted as a <new line> character and can be used to terminate a command string in place of a <new line> character. A <carriage return> followed by a <new line> is also accepted. Command string termination will always reset the current SCPI command path to the root level.

IEEE488.2 Common Commands

The IEEE-488.2 standard defines a set of common commands that perform functions like reset, self-test, and status operations. Common commands always begin with an asterisk (*), are four to five characters in length, and may include one or more parameters. The command keyword is separated from the first parameter by a blank space. Use a semicolon (;) to separate multiple commands as shown below:

```
"*RST; *CLS; *ESE 32; *OPC?"
```

SCPI Parameter Types

The SCPI language defines several different data formats to be used in program messages and response messages.

Numeric Parameters Commands that require numeric parameters will accept all commonly used decimal representations of numbers including optional signs, decimal points, and scientific notation.

Special values for numeric parameters like `MINimum`, `MAXimum` and `DEFault` are also accepted. You can also send engineering unit suffixes with numeric parameters (e.g., `M`, `K`, or `u`). If only specific numeric values are accepted, the power/energy meter will automatically round the input numeric parameters. The following command uses a numeric parameter:

```
POWer:REFerence {MINimum|MAXimum|DEFault|<numeric_value>[W]}
```

Discrete Parameters Discrete parameters are used to program settings that have a limited number of values (like `W`, `DBM`). They can have a short form and a long form just like command keywords. You can mix upper- and lower-case letters. Query responses will *always* return the short form in all upper-case letters. The following command uses discrete parameters:

```
POW:UNIT {W|DBM}
```

Boolean Parameters Boolean parameters represent a single binary condition that is either true or false. For a false condition, the power/energy meter will accept "OFF" or "0". For a true condition, the meter will accept "ON" or "1". When you query a boolean setting, the instrument will *always* return "0" or "1". The following command uses a boolean parameter:

```
CURRent:RANGe:AUTO {OFF|0|ON|1}
```

String Parameters String parameters can contain virtually any set of ASCII characters. A string *must* begin and end with matching quotes; either with a single quote or with a double quote. You can include the quote delimiter as part of the string by typing it twice without any characters in between. The following command uses a string parameter:

```
DIAG:CALString <quoted string>
```

5.5.2 IEEE488.2 Common Commands

Common commands are device commands that are common to all devices according to the IEEE488.2 standard. These commands are designed and defined by this standard. Most of the commands are described in detail in this section. The following common commands associated with the status structure are covered in the “Status Structure” section: *CLS, *ESE, *ESE?, *ESR?, *SRE, *SRE?, *STB?

5.5.2.1 Command Summary

Mnemonic	Name	Description
*CLS	Clear status	Clears all event registers and Error Queue
*ESE <NRf>	Event enable command	Program the Standard Event Enable Register
*ESE?	Event enable query	Read the Standard Event Enable Register
*ESR?	Event status register query	Read and clear the Standard Event Register
*IDN?	Identification query	Read the unit’s identification string
*OPC	Operation complete command	Set the Operation Complete bit in the Standard Event Register
*OPC?	Operation complete query	Places a “1” into the output queue when all device operations have been completed
*RST	Reset command	Returns the unit to the *RST default condition
*SRE <NRf>	Service request enable command	Programs the Service Request Enable Register
*SRE?	Service request enable query	Reads the Service Request Enable Register
*STB?	Status byte query	Reads the Status Byte Register
*TST?	Self-test query	Performs the unit’s self-test and returns the result.
*WAI	Wait-to-continue command	Wait until all previous commands are executed

5.5.2.2 Command Reference

***IDN? – identification query - read identification code**

The identification code includes the manufacturer, model code, serial number, and firmware revision levels and is sent in the following format: THORLABS,MMM,SSS,X.X.X

Where: MMM is the model code
 SSS is the serial number
 X.X.X is the instrument firmware revision level

***OPC – operation complete - set OPC bit**

***OPC? – operation complete query – places a “1” in output queue**

When *OPC is sent, the OPC bit in the Standard Event Register will set after all pending command operations are complete. When *OPC? is sent, an ASCII “1” is placed in the Output Queue after all pending command operations are complete.

Typically, either one of these commands is sent after the INITiate command. The INITiate command is used to take the instrument out of idle in order to perform measurements. While operating within the trigger model layers, many sent commands will not execute. After all programmed operations are completed, the instrument returns to the idle state at which time all pending commands (including *OPC and/or *OPC?) are executed. After the last pending command is executed, the OPC bit and/or an ASCII “1” is placed in the Output Queue.

When *OPC is sent, the OPC bit in the Standard Event Register will set after all pending command operations are complete. When *OPC? is sent, an ASCII “1” is placed in the Output Queue after all pending command operations are complete.

***RST – reset – return instrument to defaults**

When the *RST command is sent, the instrument performs the following operations:

- Returns the instrument to the default conditions
- Cancels all pending commands.
- Cancels response to any previously received *OPC and *OPC? commands.

***TST? – self-test query – run self test and read result**

Use this query command to perform the instrument self-test routine. The command places the coded result in the Output Queue. A returned value of zero (0) indicates that the test passed, other values indicate that the test failed.

***WAI – wait-to-continue – wait until previous commands are completed**

The *WAI command is a no operation command for the instrument and thus, does not need to be used. It is there for conformance to IEEE488.2.

5.5.2.3 PM400 specific SCPI Command Reference

See also SCPI Specification, Version 1999.0, May, 1999, <http://www.scpiconsortium.org> . All commands with a 'SCPI' checkmark are described in the SCPI specification.

All described commands work also with the PM100D, PM100A, PM100USB and PM160 instruments (with some limitations due to the hardware capabilities).

5.5.2.3.1 SYSTEM subsystem commands

Command	Description														
SYSTEM	Path to SYSTEM subsystem. (SCPI Vol.2 §21)														
:BEEPer															
[:IMMediate]	Issue an audible signal. (SCPI Vol.2 §21.2.2)														
:STATe {ON 1 OFF 0}	Activate/deactivate the beeper. (SCPI Vol.2 §21.2.3)														
:STATe?	Return the state of the the beeper (SCPI Vol.2 §21.2.3)														
:ERRor															
[:NEXT]?	Returns the latest <error code, "message">. (SCPI Vol.2 §21.8.8)														
:VERSion?	Query level of SCPI standard (1999.0) . (SCPI Vol.2 §21.21)														
:DATE <year>,<month>,<day>	Sets the instrument's calendar. (SCPI Vol.2 §21.7)														
:DATE?	Query the instrument's calendar. (SCPI Vol.2 §21.7)														
:TIME <hour>,<min>,<sec>	Sets the instrument's clock. (SCPI Vol.2 §21.19)														
:TIME?	Query the instrument's clock. (SCPI Vol.2 §21.19)														
:LFRequency <numeric value>	Sets the instrument's line frequency setting to 50 or 60Hz. (SCPI Vol.2 §21.13)														
:LFRequency?	Query the instrument's line frequency setting. (SCPI Vol.2 §21.13)														
:SENSor															
:IDN?	<p>Query information about the connected sensor. This is a query only command. The response consists of the following fields: <name>,<sn>,<cal_msg>,<type>,<subtype>,<flags></p> <p><name> Sensor name in string response format <sn> Sensor serial number in string response format <cal_msg> calibration message in string response format <type> Sensor type in NR1 format <subtype> Sensor subtype in NR1 format <flags> Sensor flags as bitmap in NR1 format.</p> <table> <thead> <tr> <th>Flag:</th> <th>Dec.value:</th> </tr> </thead> <tbody> <tr> <td>Is power sensor</td> <td>1</td> </tr> <tr> <td>Is energy sensor</td> <td>2</td> </tr> <tr> <td>Response settable</td> <td>16</td> </tr> <tr> <td>Wavelength settable</td> <td>32</td> </tr> <tr> <td>Tau settable</td> <td>64</td> </tr> <tr> <td>Has temperature sensor</td> <td>256</td> </tr> </tbody> </table>	Flag:	Dec.value:	Is power sensor	1	Is energy sensor	2	Response settable	16	Wavelength settable	32	Tau settable	64	Has temperature sensor	256
Flag:	Dec.value:														
Is power sensor	1														
Is energy sensor	2														
Response settable	16														
Wavelength settable	32														
Tau settable	64														
Has temperature sensor	256														

5.5.2.3.2 STATus subsystem commands

Command	Description
STATus	Path to STATus subsystem. (SCPI Vol.2 §20)
:MEASurement	Path to control measurement event registers
[:EVENT]?	Read the event register
:CONDition?	Read the condition register
:PTRansition <value>	Program the positive transition filter
:PTRansition?	Read the positive transition filter
:NTRansition <value>	Program the negative transition filter
:NTRansition?	Read the negative transition filter
:ENABle <value>	Program the enable register
:ENABle?	Read the enable register
:AUXiliary	Path to control measurement event registers
[:EVENT]?	Read the event register
:CONDition?	Read the condition register
:PTRansition <value>	Program the positive transition filter
:PTRansition?	Read the positive transition filter
:NTRansition <value>	Program the negative transition filter
:NTRansition?	Read the negative transition filter
:ENABle <value>	Program the enable register
:ENABle?	Read the enable register
:OPERation	Path to control operation event registers
[:EVENT]?	Read the event register
:CONDition?	Read the condition register
:PTRansition <value>	Program the positive transition filter
:PTRansition?	Read the positive transition filter
:NTRansition <value>	Program the negative transition filter
:NTRansition?	Read the negative transition filter
:ENABle <value>	Program the enable register
:ENABle?	Read the enable register
:QUEStionable	Path to control questionable event registers
[:EVENT]?	Read the event register
:CONDition?	Read the condition register
:PTRansition <value>	Program the positive transition filter
:PTRansition?	Read the positive transition filter
:NTRansition <value>	Program the negative transition filter
:NTRansition?	Read the negative transition filter
:ENABle <value>	Program the enable register
:ENABle?	Read the enable register
:PRESet	Return status registers to default states.

5.5.2.3.3 DISPlay subsystem commands

Command	Description
DISPlay	Path to DISPlay subsystem. (SCPI Vol.2 §8)
:BRIGhtness <value>	Set the display birghtness. (SCPI Vol.2 §8.2)
:BRIGhtness?	Return the display birghtness value. (SCPI Vol.2 §8.2)
:CONTRast <value>	Set the display contrast. (SCPI Vol.2 §8.4)
:CONTRast?	Return the display conrast value. (SCPI Vol.2 §8.4)

5.5.2.3.4 CALibration subsystem commands

Command	Description
CALibration	Path to CALibration subsystem. (SCPI Vol.2 §5)
:STRing?	Returns a human readable calibration string. This is a query only command. The response is formatted as string response data.

5.5.2.3.5 SENSE subsystem commands

Command	Description
SENSe	Path to SENSE subsystem. (SCPI Vol.2 §18)
AVERage	
[:COUNt] <value>	Sets the averaging rate (1 sample takes approx. 3ms)
[:COUNt]?	Queries the averaging rate
CORRection	
[:LOSS[:INPut[:MAGNitude]]] {MINimum MAXimum DEFault <numeric_value>}	Sets a user attenuation factor in dB
[:LOSS[:INPut[:MAGNitude]]]? [{MINimum MAXimum DEFault}]	Queries the user attenuation factor
COLLect	
ZERO	
[:INITiate]	Performs zero adjustment routine
ABORt	Aborts zero adjustment routine
STATe?	Queries the zero adjustment routine state
MAGNitude?	Queries the zero value
BEAMdiameter {MINimum MAXimum DEFault <numeric_value>[mm]}	Sets the beam diameter in mm
BEAMdiameter? [{MINimum MAXimum DEFault}]	Queries the beam diameter
WAVelength {MINimum MAXimum <numeric_value>[nm]}	Sets the operation wavelength in nm
WAVelength? [{MINimum MAXimum}]	Queries the operation wavelength
POWer	
[:PDIODE]	Sets the photodiode response value in A/W

Command	Description
<code>[:RESPonse] {MINimum MAXimum DEFault <numeric_value>[A]}</code>	
<code>[:RESPonse]? [{MINimum MAXimum DEFault}]</code>	Queries the photodiode response value
<code>:THERmopile</code>	
<code>[:RESPonse] {MINimum MAXimum DEFault <numeric_value>[V]}</code>	Sets the thermopile response value in V/W
<code>[:RESPonse]? [{MINimum MAXimum DEFault}]</code>	Queries the thermopile response value
<code>ENERgy</code>	
<code>[:PYRO]</code>	
<code>[:RESPonse] {MINimum MAXimum DEFault <numeric_value>[V]}</code>	Sets the pyro-detector response value in V/J
<code>[:RESPonse]? [{MINimum MAXimum DEFault}]</code>	Queries the pyro-detector response value
<code>CURRent [:DC]</code>	
<code>RANGe</code>	
<code>AUTO {OFF 0 ON 1}</code>	Switches the auto-ranging function on and off
<code>AUTO?</code>	Queries the auto-ranging function state
<code>[:UPPer] {MINimum MAXimum <numeric_value>[A]}</code>	Sets the current range in A
<code>[:UPPer]? [{MINimum MAXimum}]</code>	Queries the current range
<code>REFerence {MINimum MAXimum DEFault <numeric_value>[A]}</code>	Sets a delta reference value in A
<code>REFerence? [{MINimum MAXimum DEFault}]</code>	Queries the delta reference value
<code>STATe {OFF 0 ON 1}</code>	Switches to delta mode
<code>STATe?</code>	Queries the delta mode state
<code>ENERgy</code>	
<code>RANGe</code>	
<code>[:UPPer] {MINimum MAXimum <numeric_value>[J]}</code>	Sets the energy range in J
<code>[:UPPer]? [{MINimum MAXimum}]</code>	Queries the energy range
<code>REFerence {MINimum MAXimum DEFault <numeric_value>[J]}</code>	Sets a delta reference value in J
<code>REFerence? [{MINimum MAXimum DEFault}]</code>	Queries the delta reference value
<code>STATe {OFF 0 ON 1}</code>	Switches to delta mode
<code>STATe?</code>	Queries the delta mode state
<code>FREQuency</code>	
<code>Range</code>	

Command	Description
[UPPer]?	Queries the frequency range
LOWer?	
POWer[:DC]	
RANGe	
AUTO {OFF 0 ON 1}	Switches the auto-ranging function on and off
AUTO?	Queries the auto-ranging function state
[:UPPer] {MINmum MAXimum <numeric_value>[W]}	Sets the power range in W
[:UPPer]? [{MINimum MAXimum}]	Queries the power range
REFerence {MINimum MAXimum DEFAULT <numeric_value>[W]}	Sets a delta reference value in W
REFerence? [{MINimum MAXimum DEFAULT}]	Queries the delta reference value
STATe {OFF 0 ON 1}	Switches to delta mode
STATe?	Queries the delta mode state
UNIT {W DBM}	Sets the power unit W or dBm
UNIT?	Queries the power unit
VOLTage[:DC]	
RANGe	
AUTO {OFF 0 ON 1}	Switches the auto-ranging function on and off
AUTO?	Queries the auto-ranging function state
[:UPPer] {MINmum MAXimum <numeric_value>[V]}	Sets the current range in V
[:UPPer]? [{MINimum MAXimum}]	Queries the current range
REFerence {MINimum MAXimum DEFAULT <numeric_value>[V]}	Sets a delta reference value in V
REFerence? [{MINimum MAXimum DEFAULT}]	Queries the delta reference value
STATe {OFF 0 ON 1}	Switches to delta mode
STATe?	Queries the delta mode state
PEAKdetector	
[:THReshold] {MINimum MAXimum DEFAULT <numeric_value>}	Sets the trigger level in % for the energy mode
[:THReshold]? [{MINimum MAXimum DEFAULT}]	Queries the trigger level setting

5.5.2.3.6 INPut subsystem commands

Command	Description
INPut [:PDIode] :FILTER [:LPASSs] [STATE] {OFF 0 ON 1} [STATE]?	Sets the bandwidth of the photodiode input stage Queries the bandwidth of the photodiode input stage
:THERMOpile :ACCElerator [STATE] {OFF 0 ON 1} [STATE]? :AUTO {OFF 0 ON 1} ? :TAU {MINimum MAXimum DEFault <numeric_value>[s]} :TAU? [{MINimum MAXimum DEFault}]	Sets the thermopile accelerator state Queries the thermopile accelerator state Sets the thermopile accelerator to auto mode Queries thermopile accelerator auto mode Sets thermopile time constant 0-63% in s Queries the thermopile time constant in s
:ADAPter [:TYPE] {PHOTodiode THERmal PYRo} [:TYPE]?	Sets default sensor adapter type Queries default sensor adapter type

5.5.2.3.7 Measurement commands

Command	Description
INITiate [:IMMediate]	Start measurement
ABORt	Abort measurement
CONFigure [:SCALar]	
[:POWer]	Configure for power measurement
:CURRent[:DC]	Configure for current measurement
:VOLTage[:DC]	Configure for voltage measurement
:ENERgy	Configure for energy measurement
:FREQuency	Configure for frequency measurement
:PDENsity	Configure for power density measurement
:EDENsity	Configure for energy density measurement
:RESistance	Configure for sensor presence resistance measurement
:TEMPerature	Configure for sensor temperature measurement
MEASure [:SCALar]	
[:POWer]	Performs a power measurement
:CURRent[:DC]	Performs a current measurement
:VOLTage[:DC]	Performs a voltage measurement
:ENERgy	Performs a energy measurement
:FREQuency	Performs a frequency measurement
:PDENsity	Performs a power density measurement
:EDENsity	Performs a energy density measurement
:RESistance	Performs a sensor presence resistance measurement
:TEMPerature	Performs a sensor temperature measurement
FETCh?	Read last measurement data (SCPI Vol.2 §3.2)
READ?	Start new measurement and read data (SCPI Vol.2 §3.3)
CONFigure?	Query the current measurement configuration.

6 Maintenance and Service

Protect the PM400 from adverse weather conditions. The PM400 is not water resistant.

Attention

To avoid damage to the instrument, do not expose it to spray, liquids or solvents!

The unit does not need a regular maintenance by the user. It does not contain any modules and/or components that could be repaired by the user himself. If a malfunction occurs, please contact [Thorlabs](#) for return instructions.

Also, please contact [Thorlabs](#) for replacement of the rechargeable battery:

Do not remove covers!

6.1 Version Information

The [System Info screen](#) of the PM400 shows important information:

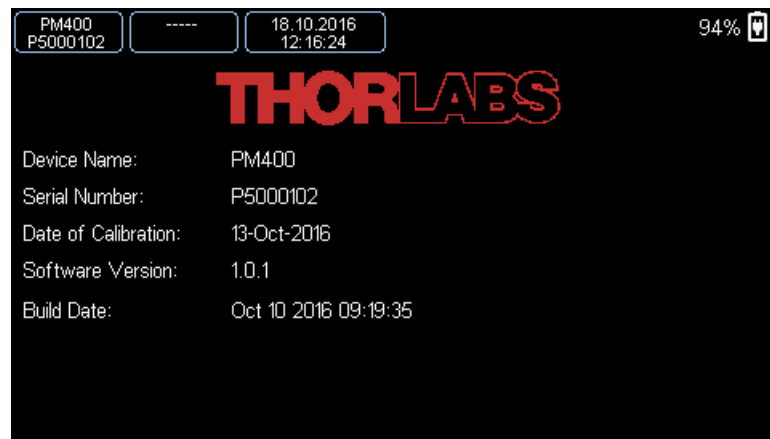

7 Appendix

7.1 Sensor Connector Pinning

The sensor connector allows the access of all Thorlabs “C-type” photodiode and thermal power sensors. The power meter interface uses the sensor calibration data, stored in the sensor connector, to calculate the corresponding actual power levels.

Additionally, the PM400 is capable to support custom made detectors. Please read the following instruction prior to connecting a self made sensor.

Warning

Pin 2 is uniquely used for the EEPROM Digital I/O (memory in Thorlabs sensor heads) and **MUST NOT** be used. Connecting this Pin may cause malfunction of the PM400.

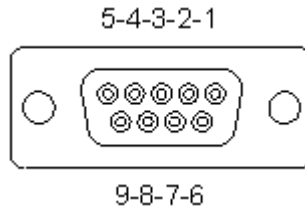

Pin-out of the DE-9 female connector (female)

Pin	Function	Description
1	Power Supply	Connect to Power supply with 5 VDC / Max Current 100 mA
2	EEPROM	Sensor Memory for the Calibration Data
3	AGND	Analog Ground for Photodiode Anode, Thermal Sensor , NTC and Pyroelectric Sensor
4	PD -	Photodiode Cathode Input
5	N.C.	Pyroelectric Sensor Cathode Input
6	DGND	Digital Ground for EEPROM and 5V Output
7	PRESENT	Connect via a 1kΩ – 10kΩ Resistor to Pin 3 (AGND) to Enable a Custom Sensor
8	TH+	Thermal Sensor Input
9	N.C.	Not Connected

Note

When connecting a Thermal Sensor for Position Measurements of the S44xC Series, the four quadrants of the S44xC Sensors are assigned. The following PIN Assignment applies:

Pin	Function	Description
1	Power Supply	Connect to Power supply with 5 VDC / Max Current 100 mA
2	EEPROM	Sensor Memory for the Calibration Data
3	AGND	Analog Ground for Photodiode Anode, Thermal Sensor , NTC and Pyroelectric Sensor
4	TH3	Thermal Sensor Input Quadrant 3
5	TH4	Thermal Sensor Input Quadrant 4
6	DGND	Digital Ground for EEPROM and 5V Output

Pin	Function	Description
7	PRESENT	Sensor Recognition
8	TH1	Thermal Sensor Input Quadrant 1
9	TH2	Thermal Sensor Input Quadrant 2

7.2 Technical Data

Features	
Detector Compatibility	Photodiode Sensors S100C Series Thermal Sensors S400C (S300C) Series Pyroelectric Sensors ES1xxC/ES2xxC Series Photodiodes (Max 5 mA) Thermopiles (Max 1 V) Pyroelectric detectors (Max 100 V)
Display Type	4.3" TFT, WQVGA, 400 x 272 Pixels, 16 bit Color
Viewing Area	95 mm x 54 mm
Display Update Rate (max)	10 Hz Numerical, 25 Hz Analog Simulation
Display Format	Numerical, Bargraph, Trendgraph, Statistics, Simulated Analog Needle, Positional Display
Backlight Display	LED, Adjustable
Features	Capacitive Touchscreen and Buttons, Support Stand, Rubberized Outside, 2 x M3 Thread Inserts for Mounting on Back Side
Current Input (Photodiode Sensors)	
Connector	DE-9
Units	W, dBm, W/cm ² , A
Measurement Ranges	6 Decades; 50 nA - 5 mA Ranges Selectable in W, Sensor Dependent
Display Resolution	1 pA / Responsivity Value (A/W)
AD Converter	16 bit
Accuracy	±0.2% f.s. (5 µA - 5 mA) ±0.5% f.s. (50 nA)
Bandwidth	DC - 100 kHz, Dependent on Sensor and Settings
Wavelength Correction	nm (A/W)
Beam Area Setting	Diameter 1/e ² or Rectangular x,y
Voltage Input (Thermopile Sensors)	
Connector	DB9F
Units	W, dBm, W/cm ² , V
Measurement Ranges ²⁾	9 Ranges: 2, 4, 10, 20, 40, 100, 200, 400, 1000 mV Ranges Selectable in W
Display Resolution	1 µV / Responsivity Value (V/W)
AD Converter	16 bit
Accuracy	±0.5% f.s. (10 mV - 1 V) ±1% f.s. (2mV)
Bandwidth	DC - 10 Hz, Dependent on Sensor and Settings
Time Constant Correction Range	1 s - 30 s
Wavelength Correction	Sensor Dependent; nm, (V/W)
Beam Area Setting	Diameter 1/e ² or Rectangular x,y

Voltage Input (Pyro Sensors)	
Connector	DB9F
Units	J, J/cm ² , W, W/cm ² , V
Measurement Ranges	4 Ranges: 200 mV - 2V - 20 V - 100 V Ranges Selectable in J, Sensor Dependent
Display Resolution	100 μ V / Responsivity Value (V/J)
AD Converter	16 bit
Accuracy	\pm 0.5% f.s.
Trigger Threshold	3% - 90% f.s.
Max. Repetition Rate	3 kHz
Wavelength Correction	Sensor Dependent [nm, V/J]
Beam Area Setting	Diameter 1/e ² or Rectangular x,y
Analog Output	
Connector	2p Audio 3.5 mm (Adapter to BNC included)
Signal	Amplified Input Signal - Not Corrected
Voltage Range	0 to 2 V
Accuracy	\pm 3%
Bandwidth	up to 100 kHz, Dependent on Sensor and Settings
Auxiliary In-/Output	
Connector	2 x 7 Pins, 0.1" Socket, Top Side
Function	4 x GPIO 2 x 10 bit ADC for external temperature, rel. humidity sensor +3.3 V, +/- 2.5 V (100 mA max.)
Temperature Sensor Internal to C-Series Optical Sensors	
Supported Temperature Sensor	Thermistor
Temperature Measurement Range	-10 °C to +80 °C
External Temperature Sensor	
Supported Temperature Sensor	Thermistor NTC 0.1 – 100 k Ω , B-Value 1000 – 9999 K
Temperature Measurement Range	-10 °C to +80 °C (w. TSP-TH)
Connector	3P Audio 2.5 mm
Sound	
Type	Speaker
Function	Laser Tuning Support, Console Function Support
Memory	
Type	Nand Flash
Size	4 GB
Interfaces	
Type	USB2.0
Connector	Mini-B USB

Power Management	
Battery	LiPo 3.7 V 2600 mAh
Charger	Built in; Charging Current: 0.5 / 1 A
Power Connector	Mini USB
General	
Operating Temperature Range ¹⁾	0 to 40 °C
Storage Temperature Range	-40 to 70 °C
Dimensions (W x H x D)	136 mm x 96 mm x 29 mm
Weight	0.35 kg

¹⁾ non-condensing

²⁾ For Thermal Sensors S44xC for Position Measurements, the measurement ranges are equal for all 4 sensing areas. Changing the range for one quadrant automatically applies for all 4 areas.

All technical data are valid at $23 \pm 5^\circ\text{C}$ and $45 \pm 15\%$ rel. humidity (non condensing)

7.3 Symbols and Abbreviations

In the table below are listed symbols and abbreviations that are used in the PM400 User Interface.

Symbol	Units	Description
Φ_e	W (J/s)	Optical Power (radiant Power, radiant Flux Φ_e)
Q_e	J	radiant Energy (Q_e)
E_e	W/cm ²	Irradiance
H_e	J/cm ²	Fluence (radiant Exposure)
I	A	electrical current
U	V	voltage
λ	nm	wavelength
T_λ		(spectral) Transmittance
R_λ		(spectral) Reflectance
τ	s	time constant
σ		standard deviation
t	s	Time
ATTN	(dB)	Attenuation
XMSN		Transmission
Min		Minimum
Max		Maximum
Avg		Average
T / TMP	°C, °F	Temperature
R	Ω	Resistance
R_{25}	Ω	Resistance @ 25°C
RH	%	relative Humidity
S_λ		Sensitivity
NTC		Negative Temperature Coefficient (Thermistor)
B	K	NTC Constant
f	Hz	Frequency

7.4 Safety

Attention

All statements regarding safety of operation and technical data in this instruction manual will only apply when the unit is operated correctly as it was designed for.

The power meter PM400 must not be operated in explosion endangered environments!

All modules, sensors and externally connected devices must only be operated with properly shielded connection cables.

Only with written consent from Thorlabs may changes to single components be carried out or components not supplied by Thorlabs be used.

Do not remove covers!

This precision device is only serviceable if properly packed into the complete original packaging including the plastic foam sleeves. If necessary, ask for a replacement package.

Note

This equipment has been tested and found to comply with the limits for a Class A digital device, pursuant to part 15 of the FCC Rules. These limits are designed to provide reasonable protection against harmful interference when the equipment is operated in a commercial environment. This equipment generates, uses, and can radiate radio frequency energy and, if not installed and used in accordance with the instruction manual, may cause harmful interference to radio communications. Operation of this equipment in a residential area is likely to cause harmful interference in which case the user will be required to correct the interference at his own expense.

7.5 Manufacturer Address



Manufacturer Address Europe

Thorlabs GmbH
Münchner Weg 1
D-85232 Bergkirchen
Germany
Tel: +49-8131-5956-0
Fax: +49-8131-5956-99
www.thorlabs.de
Email: europa@thorlabs.com

EU-Importer Address

Thorlabs GmbH
Münchner Weg 1
D-85232 Bergkirchen
Germany
Tel: +49-8131-5956-0
Fax: +49-8131-5956-99
www.thorlabs.de
Email: europa@thorlabs.com

7.6 Certifications and Compliances

<i>EU Declaration of Conformity</i>		
<i>in accordance with EN ISO 17050-1:2010</i>		
We:	Thorlabs GmbH	
Of:	Münchner Weg 1, 85232 Bergkirchen, Deutschland	
<i>in accordance with the following Directive(s):</i>		
2014/30/EU	Electromagnetic Compatibility (EMC) Directive	
2011/65/EU	Restriction of Use of Certain Hazardous Substances (RoHS)	
 <i>hereby declare that:</i>		
Model:	PM400	
Equipment:	Optical Power and Energy Meter	
<i>is in conformity with the applicable requirements of the following documents:</i>		
EN 61326-1	Electrical Equipment for Measurement, Control and Laboratory Use - EMC Requirements	2013
EN 61010-1	Safety Requirement for Electrical Equipment for Measurement, Control and Laboratory Use	2010
 <i>and which, issued under the sole responsibility of Thorlabs, is in conformity with Directive 2011/65/EU of the European Parliament and of the Council of 8th June 2011 on the restriction of the use of certain hazardous substances in electrical and electronic equipment, for the reason stated below:</i>		
does not contain substances in excess of the maximum concentration values tolerated by weight in homogenous materials as listed in Annex II of the Directive		
 <i>I hereby declare that the equipment named has been designed to comply with the relevant sections of the above referenced specifications, and complies with all applicable Essential Requirements of the Directives.</i>		
Signed:		On: 19 November 2019
Name:	Bruno Gross	
Position:	General Manager	EDC - PM400 - 2019-11-19
		

7.7 Warranty

Thorlabs warrants material and production of the PM400 for a period of 24 months starting with the date of shipment. During this warranty period Thorlabs will see to defaults by repair or by exchange if these are entitled to warranty.

For warranty repairs or service the unit must be sent back to Thorlabs. The customer will carry the shipping costs to Thorlabs, in case of warranty repairs Thorlabs will carry the shipping costs back to the customer.

If no warranty repair is applicable the customer also has to carry the costs for back shipment.

In case of shipment from outside EU duties, taxes etc. which should arise have to be carried by the customer.

Thorlabs warrants the hard- and/or software determined by Thorlabs for this unit to operate fault-free provided that they are handled according to our requirements. However, Thorlabs does not warrant a fault free and uninterrupted operation of the unit, of the software or firmware for special applications nor this instruction manual to be error free. Thorlabs is not liable for consequential damages.

Restriction of Warranty

The warranty mentioned before does not cover errors and defects being the result of improper treatment, software or interface not supplied by us, modification, misuse or operation outside the defined ambient stated by us or unauthorized maintenance.

Further claims will not be consented to and will not be acknowledged. Thorlabs does explicitly not warrant the usability or the economical use for certain cases of application.

Thorlabs reserves the right to change this instruction manual or the technical data of the described unit at any time.

7.8 Copyright and Exclusion of Reliability

Thorlabs has taken every possible care in preparing this document. We however assume no liability for the content, completeness or quality of the information contained therein. The content of this document is regularly updated and adapted to reflect the current status of the hardware and/or software. We furthermore do not guarantee that this product will function without errors, even if the stated specifications are adhered to.

Under no circumstances can we guarantee that a particular objective can be achieved with the purchase of this product.

Insofar as permitted under statutory regulations, we assume no liability for direct damage, indirect damage or damages suffered by third parties resulting from the purchase of this product. In no event shall any liability exceed the purchase price of the product.

Please note that the content of this document is neither part of any previous or existing agreement, promise, representation or legal relationship, nor an alteration or amendment thereof. All obligations of *Thorlabs* result from the respective contract of sale, which also includes the complete and exclusively applicable warranty regulations. These contractual warranty regulations are neither extended nor limited by the information contained in this document. Should you require further information on this product, or encounter specific problems that are not discussed in sufficient detail in the document, please contact your local *Thorlabs* dealer or system installer.

All rights reserved. This document may not be reproduced, transmitted or translated to another language, either as a whole or in parts, without the prior written permission of *Thorlabs*.

Copyright © Thorlabs 2019. All rights reserved.

7.9 Thorlabs Worldwide Contacts and WEEE Policy

For technical support or sales inquiries, please visit us at www.thorlabs.com/contact for our most up-to-date contact information.



USA, Canada, and South America

Thorlabs, Inc.
sales@thorlabs.com
techsupport@thorlabs.com

UK and Ireland

Thorlabs Ltd.
sales.uk@thorlabs.com
techsupport.uk@thorlabs.com

Europe

Thorlabs GmbH
europe@thorlabs.com

Scandinavia

Thorlabs Sweden AB
scandinavia@thorlabs.com

France

Thorlabs SAS
sales.fr@thorlabs.com

Brazil

Thorlabs Vendas de Fotônicos Ltda.
brasil@thorlabs.com

Japan

Thorlabs Japan, Inc.
sales@thorlabs.jp

China

Thorlabs China
chinasales@thorlabs.com

Thorlabs 'End of Life' Policy (WEEE)

Thorlabs verifies our compliance with the WEEE (Waste Electrical and Electronic Equipment) directive of the European Community and the corresponding national laws. Accordingly, all end users in the EC may return “end of life” Annex I category electrical and electronic equipment sold after August 13, 2005 to Thorlabs, without incurring disposal charges. Eligible units are marked with the crossed out “wheelie bin” logo (see right), were sold to and are currently owned by a company or institute within the EC, and are not disassembled or contaminated. Contact Thorlabs for more information. Waste treatment is your own responsibility. “End of life” units must be returned to Thorlabs or handed to a company specializing in waste recovery. Do not dispose of the unit in a litter bin or at a public waste disposal site.





THORLABS

www.thorlabs.com
