



**TELEDYNE LECROY**  
Everywhere you look™



# Getting Started Manual

WaveMaster 8 Zi/Zi-A  
Oscilloscopes



WaveMaster 8 Zi/Zi-A Oscilloscopes  
**Getting Started Manual**  
February, 2013





**TELEDYNE LECROY**  
Everywhereyoulook™

© 2013 Teledyne LeCroy, Inc . All rights reserved.

Unauthorized duplication of Teledyne LeCroy documentation materials other than for internal sales and distribution purposes is strictly prohibited. However, clients are encouraged to distribute and duplicate Teledyne LeCroy documentation for their own internal educational purposes.

WaveMaster and Teledyne LeCroy are registered trademarks of Teledyne LeCroy, Inc. Windows is a registered trademark of Microsoft Corporation. Other product or brand names are trademarks or requested trademarks of their respective holders. Information in this publication supersedes all earlier versions. Specifications subject to change without notice.

## **Warranty**

**NOTE:** THE WARRANTY BELOW REPLACES ALL OTHER WARRANTIES, EXPRESSED OR IMPLIED, INCLUDING BUT NOT LIMITED TO ANY IMPLIED WARRANTY OF MERCHANTABILITY, FITNESS, OR ADEQUACY FOR ANY PARTICULAR PURPOSE OR USE. TELEDYNE LECROY SHALL NOT BE LIABLE FOR ANY SPECIAL, INCIDENTAL, OR CONSEQUENTIAL DAMAGES, WHETHER IN CONTRACT OR OTHERWISE. THE CUSTOMER IS RESPONSIBLE FOR THE TRANSPORTATION AND INSURANCE CHARGES FOR THE RETURN OF PRODUCTS TO THE SERVICE FACILITY. TELEDYNE LECROY WILL RETURN ALL PRODUCTS UNDER WARRANTY WITH TRANSPORT PREPAID.

The oscilloscope is warranted for normal use and operation, within specifications, for a period of three years from shipment. Teledyne LeCroy will either repair or, at our option, replace any product returned to one of our authorized service centers within this period. However, in order to do this we must first examine the product and find that it is defective due to workmanship or materials and not due to misuse, neglect, accident, or abnormal conditions or operation.

Teledyne LeCroy shall not be responsible for any defect, damage, or failure caused by any of the following: a) attempted repairs or installations by personnel other than Teledyne LeCroy representatives or b) improper connection to incompatible equipment, or c) for any damage or malfunction caused by the use of non-Teledyne LeCroy supplies. Furthermore, Teledyne LeCroy shall not be obligated to service a product that has been modified or integrated where the modification or integration increases the task duration or difficulty of servicing the oscilloscope. Spare and replacement parts, and repairs, all have a 90-day warranty.

The oscilloscope's firmware has been thoroughly tested and is presumed to be functional. Nevertheless, it is supplied without warranty of any kind covering detailed performance. Products not made by Teledyne LeCroy are covered solely by the warranty of the original equipment manufacturer.

922133-00 Rev A  
February 2013

# TABLE OF CONTENTS

|  |           |
|--|-----------|
| <b>Welcome .....</b>                         | <b>1</b>  |
| <b>Safety Instructions .....</b>             | <b>2</b>  |
| Symbols.....                                 | 2         |
| Precautions .....                            | 2         |
| Operating Environment .....                  | 3         |
| Cooling .....                                | 3         |
| Cleaning .....                               | 4         |
| Calibration.....                             | 4         |
| Power .....                                  | 4         |
| <b>Hardware .....</b>                        | <b>6</b>  |
| The Front of Your Oscilloscope .....         | 6         |
| Front Panel.....                             | 7         |
| Input/Output Panel.....                      | 9         |
| The Back of Your Oscilloscope .....          | 10        |
| <b>Basic Controls .....</b>                  | <b>11</b> |
| Front Panel Controls .....                   | 11        |
| <b>Probe and Signal Interfaces .....</b>     | <b>17</b> |
| Overview .....                               | 17        |
| Probe Interfaces.....                        | 18        |
| ProLink Interface Adapters .....             | 22        |
| ProLink Probe Adapters .....                 | 24        |
| Probes .....                                 | 24        |
| Passive Probe Compensation .....             | 25        |
| <b>Display .....</b>                         | <b>26</b> |
| Screen Layout, Groupings, and Controls ..... | 26        |
| Menu Bar .....                               | 26        |
| The Quick Access Toolbar .....               | 27        |
| The Signal Display Grid .....                | 27        |
| Trace Descriptor Labels .....                | 29        |

# WaveMaster 8 Zi/Zi-A Oscilloscopes

---

|   |           |
|---|-----------|
| Dialog Area.....                                    | 33        |
| Shortcut Toolbar Buttons.....                       | 38        |
| Message Bar.....                                    | 39        |
| <b>Turning on Channels and Traces.....</b>          | <b>39</b> |
| <b>Timebase.....</b>                                | <b>40</b> |
| Overview.....                                       | 40        |
| Timebase Setup and Control.....                     | 40        |
| Combining Channels.....                             | 41        |
| <b>Sampling Modes.....</b>                          | <b>45</b> |
| Overview.....                                       | 45        |
| Selecting a Sampling Mode.....                      | 45        |
| Single-shot Sampling Mode.....                      | 45        |
| Sequence Sampling Mode – Working with Segments..... | 46        |
| RIS Sampling Mode for Higher Sampling Rates.....    | 53        |
| Roll Mode.....                                      | 54        |
| <b>Vertical.....</b>                                | <b>54</b> |
| Overview.....                                       | 54        |
| Channel Controls.....                               | 55        |
| Shortcut Toolbar Buttons.....                       | 57        |
| Pre-Processing Controls.....                        | 58        |
| Response Optimization Modes.....                    | 59        |
| <b>Trigger.....</b>                                 | <b>61</b> |
| Overview.....                                       | 61        |
| Trigger Types.....                                  | 62        |
| Trigger Settings.....                               | 67        |
| Trigger Setup.....                                  | 68        |
| TriggerScan.....                                    | 73        |
| <b>Viewing Waveforms.....</b>                       | <b>77</b> |
| Display.....  | 77        |
| Persistence.....                                    | 82        |

|   |            |
|---|------------|
| WaveStream Display Mode .....                         | 84         |
| Adjusting Trace Intensity .....                       | 84         |
| <b>Zooming Waveforms.....</b>                         | <b>85</b>  |
| Overview .....  | 85         |
| Previewing Zoomed Waveforms.....                      | 85         |
| Zooming a Single Channel.....                         | 86         |
| Touch-and-Drag Zooming .....                          | 88         |
| Quickly Zooming Waveforms and Multiple Waveforms..... | 88         |
| Turning Off Zoom.....                                 | 88         |
| <b>Measuring with Cursors .....</b>                   | <b>89</b>  |
| Overview .....  | 89         |
| Cursor Types .....                                    | 89         |
| Cursors Setup.....                                    | 89         |
| <b>Measurement Parameters.....</b>                    | <b>92</b>  |
| Overview .....  | 92         |
| Parameter Setup.....                                  | 93         |
| Measure Modes.....                                    | 95         |
| Help Markers .....                                    | 95         |
| <b>Measurement Parameter Analysis.....</b>            | <b>98</b>  |
| Overview .....  | 98         |
| Creating and Viewing a Histogram .....                | 99         |
| Creating and Viewing a Trend.....                     | 105        |
| Creating a Track View .....                           | 106        |
| Pass-Fail Parameter Testing.....                      | 107        |
| <b>Math .....</b>                                     | <b>114</b> |
| Overview .....  | 114        |
| Math Setup .....                                      | 115        |
| <b>Mask Testing .....</b>                             | <b>117</b> |
| Creating a Mask .....                                 | 117        |
| Quick Access to Pass/Fail Setup Dialogs .....         | 118        |

# WaveMaster 8 Zi/Zi-A Oscilloscopes

---

|  |            |
|--|------------|
| Removing a Mask from the Display .....               | 118        |
| Right-Hand Dialogs.....                              | 119        |
| <b>WaveScan Overview .....</b>                       | <b>120</b> |
| Signal Views .....                                   | 121        |
| Search Modes .....                                   | 122        |
| Parameter Measurements.....                          | 122        |
| Sampling Mode .....                                  | 122        |
| <b>Customization Overview .....</b>                  | <b>123</b> |
| <b>Documenting Your Work Using LabNotebook .....</b> | <b>124</b> |
| Overview .....                                       | 124        |
| LabNotebook Dialog.....                              | 125        |
| Notebook Entries .....                               | 126        |
| <b>Save/Recall.....</b>                              | <b>129</b> |
| Overview .....                                       | 129        |
| Saving and Recalling Setups.....                     | 130        |
| Saving and Recalling Waveforms .....                 | 131        |
| <b>Utilities .....</b>                               | <b>136</b> |
| Overview .....                                       | 136        |
| Utilities Setup.....                                 | 136        |
| Disk Utilities .....                                 | 147        |
| Preferences Setup.....                               | 148        |
| <b>System Recovery .....</b>                         | <b>156</b> |
| Restoring Software with Acronis True Image .....     | 156        |
| <b>Reference .....</b>                               | <b>160</b> |
| Specifications .....                                 | 160        |
| Certifications.....                                  | 160        |
| Windows License Agreement .....                      | 163        |
| X-Stream Software End-User License Agreement .....   | 164        |
| Contact Teledyne LeCroy .....                        | 174        |
| <b>Index.....</b>                                    | <b>175</b> |



# Welcome

Thank you for purchasing a Teledyne LeCroy product. We're certain you'll be pleased with the detailed features so unique to our instruments.

This *WaveMaster8 Zi/Zi-A Getting Started Manual* is designed to cover important safety and installation information for your oscilloscope, along with standard procedures so you're quickly working on waveforms. The Teledyne LeCroy website at [teledynelecroy.com](http://teledynelecroy.com) maintains the most current specification information and the online help file on your instrument may be accessed for more comprehensive documentation. Sections of the online help residing on your oscilloscope may be printed and transferring the help file itself to a USB memory device is a fairly common procedure. Details on how to access your online help file can be found in a .pdf file on the desktop of your oscilloscope.

This manual is arranged in the following manner:

- Physical features such as hardware, basic controls, display
- Core oscilloscope functions such as timebase and vertical setup
- Special features such as customization, LabNotebook, Save/Recall (File) functions, and Utilities
- Reference, including certifications and contact information

When your product is delivered, verify that you've received all items on the packing list or invoice copy. Contact your nearest Teledyne LeCroy customer service center or national distributor if anything is missing or damaged. We can only be responsible for replacement if you contact us immediately.

We truly hope you enjoy using Teledyne LeCroy's fine products.

Sincerely,



**David C. Graef**

Teledyne LeCroy Corporation  
*Vice President and Chief Technology Officer*

# Safety Instructions

This section contains instructions that must be observed to keep the instrument operating in a correct and safe condition. You are required to follow generally accepted safety procedures in addition to the precautions specified in this section. **The overall safety of any system incorporating this instrument is the responsibility of the assembler of the system.**

## Symbols

These symbols appear on the instrument's front or rear panels and in its documentation to alert you to important safety considerations.



**CAUTION** of damage to instrument, or **WARNING** of hazard to health. Attend to the accompanying information to protect against personal injury or damage. Do not proceed until conditions are fully understood and met.



**WARNING.** Risk of electro-shock.



Measurement ground connection.



Safety (protective) ground connection.



Alternating Current.



Standby Power (front of instrument).



Power On (rear power switch); connected to AC mains.



Power Off (rear power switch); disconnected from AC mains.

## Precautions

**Use proper power cord.** Use only the power cord shipped with this instrument and certified for the country of use.

**Maintain ground.** This product is grounded through the power cord grounding conductor. To avoid electric shock, connect only to a grounded mating outlet.

**Connect and disconnect properly.** Do not connect/disconnect probes or test leads while they are connected to a voltage source.

**Observe all terminal ratings.** Do not apply a voltage to any input (C1, C2, C3, C4 or EXT) that exceeds the maximum rating of that input. Refer to the front of the oscilloscope for maximum input ratings.

**Use only within operational environment listed.** Do not use in wet or explosive atmospheres.

**Use indoors only.**

**Keep product surfaces clean and dry.**

**Do not block the cooling vents.** Leave a minimum six-inch (15 cm) gap between the instrument and the nearest object. Keep the underside clear of papers and other objects.

**Do not remove the covers or inside parts.** Refer all maintenance to qualified service personnel.

**Do not operate with suspected failures.** Do not use the product if any part is damaged. Obviously incorrect measurement behaviors (such as failure to calibrate) might indicate impairment due to hazardous live electrical quantities. Cease operation immediately and sequester the instrument from inadvertent use.

## Operating Environment

**Temperature:** 5 to 40 °C.

**Humidity:** Maximum relative humidity 80 % for temperatures up to 31 °C decreasing linearly to 50 % relative humidity at 40 °C (or at the upper operational temperature limit).

**Altitude:** Up to 10,000 ft (3,048 m) at or below 25 °C.

## Cooling

The instrument relies on forced air cooling with internal fans and vents. Take care to avoid restricting the airflow to any part of the oscilloscope. Around the sides and rear, leave a minimum of 15 cm (6 inches) between the instrument and the nearest object. At the bottom, the oscilloscope feet (up or down) provide adequate clearance.

# WaveMaster 8 Zi/Zi-A Oscilloscopes

---



**CAUTION.** Do not block oscilloscope vents. Always keep the area beneath the oscilloscope clear of paper and other items.

The instrument also has internal fan control circuitry that regulates the fan speed based on the ambient temperature. This is performed automatically after start-up.

## Cleaning

Clean only the exterior of the oscilloscope using a damp, soft cloth. Do not use harsh chemicals or abrasive elements. Under no circumstances submerge the instrument or allow moisture to penetrate it. Avoid electric shock by unplugging the power cord from the AC outlet before cleaning.



**CAUTION.** Do not attempt to clean internal parts. Refer to qualified service personnel.

## Calibration

The oscilloscope is calibrated at the factory prior to being shipped. The recommended calibration interval is one year. Calibration should be performed by qualified personnel only.

The oscilloscope software includes automatic and manual calibration functions.



**CAUTION.** It is required that all inputs be removed from the oscilloscope prior to performing a manual calibration.

Schedule an annual factory calibration as part of your regular maintenance. Extended warranty, calibration, and upgrade plans are available for purchase. Contact your Teledyne LeCroy sales representative or [customersupport@teledynelecroy.com](mailto:customersupport@teledynelecroy.com) to purchase a service plan.

## Power

### **AC Power Source**

100 to 240 VAC (+/-10%) at 45-66; 100-120 VAC at 380-420 Hz; Automatic AC voltage selection; Installation Category: 300V CAT II.

Manual voltage selection is not required because the instrument automatically adapts to line voltage.

### **Power Consumption**

≤ 975 watts (975 VA) for 4 - 16 GHz 8 Zi series models and 4 - 20 GHz 8 Zi-A series models.

≤ 1025 watts (1025 VA) for 20 - 30 GHz 8 Zi series models and 25 - 45 GHz 8 Zi-A series models (depending on accessories installed).

Power consumption in Standby Mode: 22 Watts.

### **Power and Ground Connections**

The instrument is provided with a 15A/250V 14AWG rated grounded cord set containing a molded three-terminal polarized plug and a specific IEC-60320 (Type C15) connector for making line voltage and safety ground connections.

The AC inlet ground is connected directly to the frame of the instrument. For adequate protection against electric shock, connect to a mating outlet with a safety ground contact.



**WARNING.** Interrupting the protective conductor inside or outside the oscilloscope, or disconnecting the safety ground terminal, creates a hazardous situation. Intentional interruption is prohibited.

### **Standby Power**

The **Standby (Power)** button controls the operational state of the oscilloscope. Press the button to switch the instrument into Standby mode (reduced power); press it again to return to full operation.

Always use the Standby button or the **File > Shutdown** menu option to execute a proper shut down process and preserve settings before powering down.

The Standby button does not disconnect the oscilloscope from the AC power supply. The only way to fully power down the instrument is to turn the rear Power switch to the **Off** position, then unplug the AC power cord from the outlet.

We recommend unplugging the instrument if it will be unused for a long period of time.

# Hardware

## The Front of Your Oscilloscope

Numbered labels on this image correspond with descriptions on the following table.



| Number and Description        |   |  |
|-------------------------------|---|--|
| 1. Power Button               | 5. Volume Control and Mute Button               | 9. USB Ports                           |
| 2. Channel Row LED Indicator  | 6. Ground Connector                             | 10. Detachable Front Panel Control     |
| 3. Channel Inputs             | 7. Speaker                                      | 11. Front Panel Control Release Switch |
| 4. Auxiliary Input and Output | 8. Fast Edge, Recovered Clock, and Data Outputs |  |

## Front Panel

### *Detaching and Attaching the Front Panel Control*



Detach the **Front Panel Control** from the oscilloscope by sliding the detachment lever to the left and pulling at the right.



Attach the front panel by inserting the lower part first, sliding the detachment lever to the left, and then pushing the top in place.

## WaveMaster 8 Zi/Zi-A Oscilloscopes

### *Front Panel as a Remote Control*

While detached, your front panel (standard or 4 channel version) can be used as a remote control. Just plug-and-play connect to the oscilloscope using the **USB - A to USB - Mini B** cable provided.



**Note:** While a standard front panel comes with your Zi oscilloscope, Teledyne LeCroy offers additional standard front panels or a 4 channel version (as follows) to better suit the way you work. Learn more and **Contact Teledyne LeCroy for Support.**





## Input/Output Panel

Input/output connectors are sometimes located on the right side (facing the front of the instrument) or on the rear of the instrument:

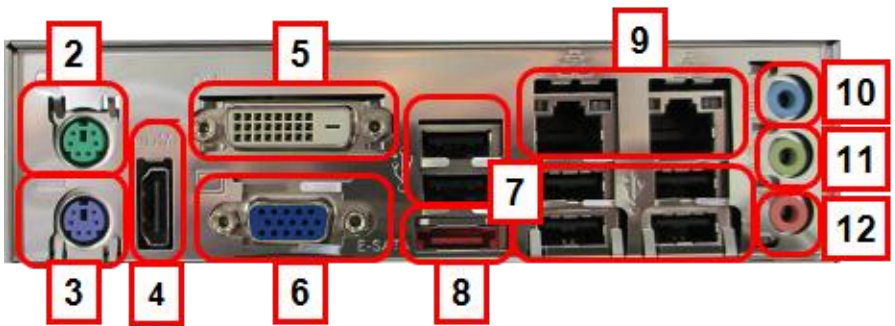

*WaveMaster 8 Zi / Zi-A oscilloscopes I/O panel.*

Numbers on this image of the I/O Panel correspond with descriptions on the following table. The exact location of a port will vary by model.

| Number and Description        |                   |
|-------------------------------|-------------------|
| 1. LBUS (Teledyne LeCroy Bus) | 7. USB Ports      |
| 2. Mouse Port                 | 8. E-SATA Port    |
| 3. Keyboard Port              | 9. Ethernet Ports |
| 4. HDMI Port                  | 10. Line In       |
| 5. DVI Port                   | 11. Speakers      |
| 6. External VGA Monitor Port  | 12. Microphone    |

## The Back of Your Oscilloscope

Numbers on this image correspond with descriptions in the following table.

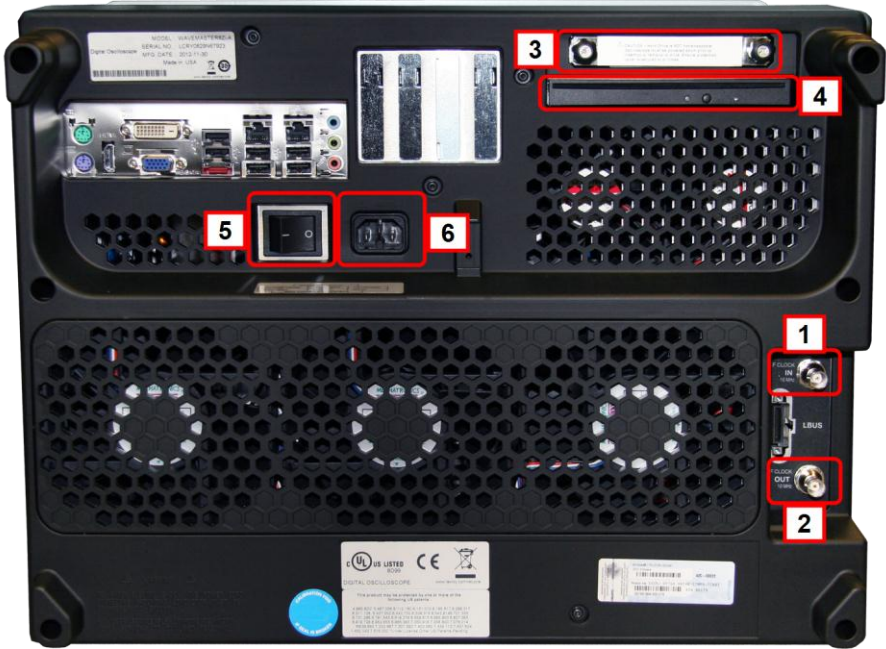

*Back of the WaveMaster 8 Zi.*

| Number and Description   |                                  |                     |
|--|----------------------------------|---------------------|
| 1. 10 MHz Reference Clock Input (Grounded EMI Shield required when port is not in use) | 2. 10 MHz Reference Clock Output | 4. DVD-CD + R Drive |
|  | 3. Removable Hard Drive          | 5. Power Switch     |
|  |                                  | 6. AC Power Plug    |

# Basic Controls

## Front Panel Controls

The front panel is divided into sections based on various functions.

**Note:** Many Front Panel Controls duplicate Display controls. For example, depending on how it is configured, the front panel Print button duplicates the File > Print menu option.



## Miscellaneous Controls / WaveStream Indicator

- **Help** - Press to open the Teledyne LeCroy Online Assistant where you can click to open the oscilloscope online help table of contents, index, or search for a topic using a keyword. If the second monitor is installed, the online help opens on the second monitor.



- **Default Setup** - Press to reset the oscilloscope's settings to the default configuration. Corresponds with screen menu selection: **File** → **Recall Setup** → **Recall Default Setup...** For a list of default settings, see **Save/Recall** → **Saving and Recalling Setups** (on page 130).
- **Auto Setup** - Press once and the **Auto Setup...** flyout menu opens.



**OR**

From the menu bar, touch the **Auto Setup...** selection from the **Vertical**, **Timebase**, or **Trigger** menus.

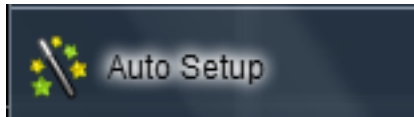

Press the **Auto Setup...** button on the flyout menu to perform a full auto setup.

Press a **Channel Find Scale** button on the flyout menu to perform a quick auto setup for that channel only. Press the **AUTO SETUP...** front panel button twice to perform the last selection from the **Auto Setup...** flyout menu (the default is to perform a full auto setup).

If Auto Setup is run when no channels are turned on, all channels are affected. When more than one channel is turned on, the first channel with a signal applied to it is automatically set up for edge triggering.

Perform an autoseup of all these functions together by pressing the **Auto Setup...** front panel button.

- **WaveStream** - Indicates when WaveStream mode is ON.
- **Intensity** - Press to toggle between WaveStream OFF and ON for Analog Persistence and WaveStream ON for Color Persistence. When you turn the knob, if WaveStream is ON, the WaveStream display intensity changes. When you turn the knob, if WaveStream is OFF, changes the Intensity setting. Corresponds with the screen menu selection: **Display → Display Setup** (on page 78).

### Trigger Front Panel Controls



- **Level** - Pressing this button sets the trigger level to 50%. Turn the knob to change the trigger threshold level. The threshold level is indicated on the Trigger label.
- **READY and TRIG'D Indicators** - The READY indicator is lit when the trigger is armed. TRIG'D is lit momentarily when a trigger occurs. A fast trigger rate causes the light to stay lit continuously.
- **Setup** - Press once to open the **Trigger Setup...** dialog. Corresponds with screen menu selection: **Trigger → Trigger Setup....** Press the Trigger SETUP front panel button again to close the **Trigger Setup...** dialog.
- **Auto** - Press to turn on **Auto Trigger** mode, which triggers the oscilloscope after a time-out, even if the trigger conditions are not met.
- **Normal** - Press to turn on **Normal Trigger** mode, which triggers the oscilloscope each time a signal is present that meets the conditions set for the type of trigger selected.
- **Single** - Press to turn on **Single Trigger** mode, which arms the oscilloscope to trigger once (single-shot acquisition) when the input

## WaveMaster 8 Zi/Zi-A Oscilloscopes

signal meets the trigger conditions set for the type of trigger selected. If the scope is already armed, it will force a trigger.

- **Stop** - Press to prevent the scope from triggering on a signal. If you boot up the instrument with the trigger in **Stop** mode, a **no trace available** message is shown. Press the Trigger AUTO front panel button to display your trace.

### Horizontal Front Panel Controls

**Note:** Horizontal front panel controls correspond with screen menu selection: **Timebase** → **Horizontal Setup**...



- **Delay** - Press to toggle between a zero horizontal delay value and the previous horizontal delay value. Turn to change the horizontal delay value.
- **Time/Div** - Turn to set the time/division of the oscilloscope timebase (acquisition system).

### Vertical Front Panel Controls

**Note:** You can turn channels on and off using the software as explained in *Vertical Overview* (on page 54).



- **Channels** - The channel buttons control both channel ON/OFF and which channel is active for the Vertical Offset and Volts/Div knobs controls. If a channel is OFF, pressing that channel button turns it on and makes it active. If a channel button is ON, pressing that channel button makes it active, and then pressing it a second time turns it OFF.
- **Offset** - Press to toggle between a zero vertical offset value and the previous vertical offset value for the selected channel. Turn to change the vertical offset value for the selected channel.
- **Gain** - Press to toggle between fixed and variable gain adjustment. Turn to change the gain value.

### Zoom and Math Front Panel Controls

**Note:** Zoom and Math front panel controls correspond with screen menu selection: Math → Zoom Setup....

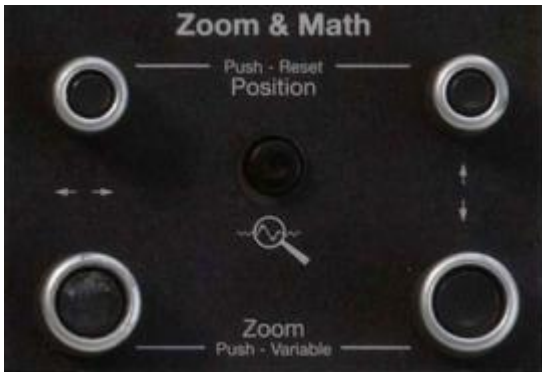

- **Horizontal Position** - Press to reset the horizontal zoom position to zero. Turn to change the horizontal position of the selected math or zoom trace.
- **Horizontal Ratio** - Press to toggle between fixed and variable horizontal zoom ratio adjustment. Turn to change the horizontal zoom ratio of the selected math trace.
- **Quick Zoom** - Press to automatically display magnified views of up to four signal inputs on multiple grids. With four input signals, the signals are displayed along with four zoom traces, each on its own grid. Pressing this button also turns off all other traces.
- **Vertical Position** - Press to reset the vertical zoom position to zero. Turn to change the vertical position of the selected math or zoom trace.
- **Vertical Ratio** - Press to toggle between fixed and variable vertical zoom ratio adjustment. Turn to change the vertical zoom ratio of the selected math trace.



# Probe and Signal Interfaces

## Overview

Teledyne LeCroy oscilloscopes are equipped with a variety of connection interfaces to allow connection of cables directly to the oscilloscope channels, or to allow probe connections to the oscilloscope. When probes are connected, a probe interface is used to power the probe (as necessary), to recognize the probe type and its characteristics, and to communicate to and from the probe to completely integrate the probe with the oscilloscope channel in a number of ways. For instance, active single-ended and differential voltage probes and current probes use these interfaces upload gain and offset correction factors from the probe EEPROM's and, in some cases, automatically compensates responses to achieve fully-calibrated measurements.

Some oscilloscope product series support multiple probe and connection interfaces. This can be an advantage when the highest speed signal on a design requires the use of a high-bandwidth oscilloscope, yet it is also highly desired to view other low-speed signals in conjunction with the highest-speed signals so as to debug or analyze a complicated embedded design. An example would be a high-speed serial data interface, such as PCIe, that may interoperate with low-speed signals, such as I<sup>2</sup>C or power supply lines. In this case, the multiple connection interfaces in a single high-bandwidth oscilloscope would allow connection of passive voltage probes, current probes, and high-bandwidth differential probes without the use of additional adapters that cost extra money and may be easily lost or misplaced. Multiple probe and connection interfaces also provide users the ability to connect two probes to the circuit on a single channel and switch between them without disconnecting and re-connecting probes from the circuit. This function is remotely programmable allowing the interface to operate like a switch, and the ability to select four out of eight inputs provides unheard of connection flexibility.

**Note:** AUX INPUT and AUX OUTPUT connections are typically located on the Front of the oscilloscope.

### Probe Interfaces

Teledyne LeCroy oscilloscopes utilize one or more proprietary probe interfaces providing a complete measurement solution from probe tip to oscilloscope display. Compared to standard BNC and Probe Ring interfaces, this intelligent interconnection between your instrument and the probe or accessory eliminates the guesswork and errors that occur when probe settings are made manually, and also offers the following important signal fidelity advantages:

- Upon connection to the oscilloscope channel, the probe is recognized and some setup information, such as input coupling and attenuation, is performed automatically.
- System (probe plus oscilloscope) gain settings are automatically calculated and displayed based on the probe attenuation.
- Active probes typically provide automatic matching of probe to oscilloscope response using probe response data stored in an on-board EEPROM. This ensures the best possible combined probe plus oscilloscope channel frequency response without requiring the user to perform any de-embedding procedure.

Probe interfaces differ in bandwidth, so the interfaces contained on your oscilloscope depend on the bandwidth rating of the oscilloscope model you purchased.

**Note:** The lowest bandwidth oscilloscopes contain only a BNC and perhaps a Probe Ring interface; whereas, the highest bandwidth oscilloscopes may contain every type of probe interface Teledyne LeCroy supports.

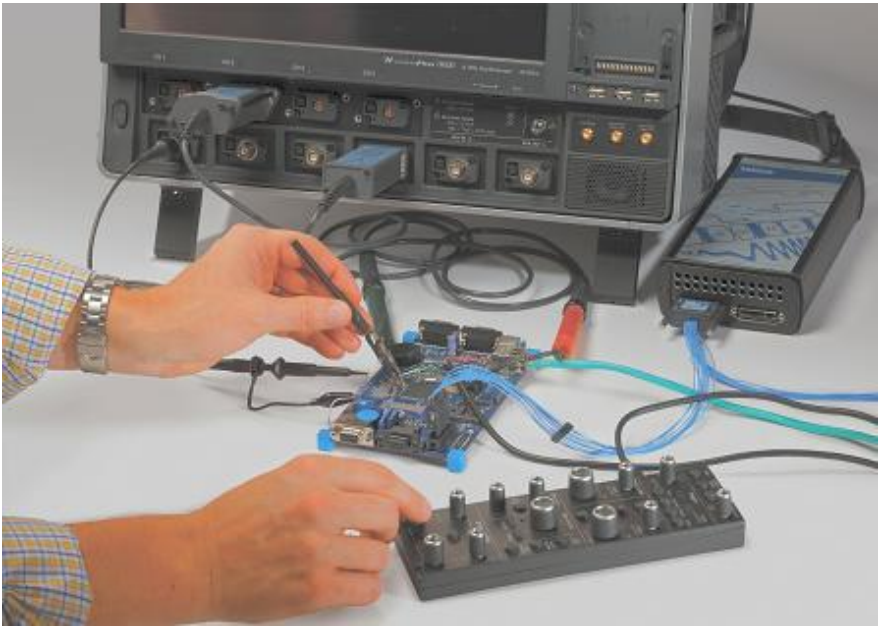

***A Teledyne LeCroy Zi series oscilloscope showing the four sets of ProBus/ProLink probe interfaces. Zi oscilloscopes are compatible with all Teledyne LeCroy probes.***

The following figure shows a typical channel setup dialog on a Teledyne LeCroy oscilloscope containing both ProLink (Input A, Upper) and ProBus (Input B, Lower) interfaces. The input selection is on the left-hand side of the dialog box. In this case the A input, the ProLink interface is selected. When the probe is not connected, there is only a C1 tab selection for vertical channel setup and the user has the ability to select input coupling and probe attenuation.



***The channel dialog layout showing Input A's ProLink interface controls setup before connection.***

## WaveMaster 8 Zi/Zi-A Oscilloscopes

When a probe is connected, it is recognized and an additional tab with the probe model name is displayed to the right of the C1 tab.



*The channel dialog layout showing Input A's ProLink interface controls setup after connection.*

This additional tab contains specific information on the connected probe. In addition, default values for the probes coupling and attenuation (which may not be changed) are automatically downloaded from the probe, and these settings along with other attributes are shown on the corresponding probe dialog.



*The dialog showing the connected probe's control attributes.*

### **ProBus Probe and Cable Connecting Interface**

The ProBus interface contains a 6-pin power and communication connection and a BNC signal connection to the probe. It offers both 50  $\Omega$ /1 M $\Omega$  input impedance and provides probe power and control for a wide range of probes such as high impedance passive probes, high impedance active probes, current probes, high voltage probes, and differential probes. ProBus also includes sense rings for detecting passive probes. The ProBus interface may also have a BNC-terminated cable connected directly to it.

ProBus is based on a BNC connector and, depending on the exact BNC connector used and the oscilloscope design, is rated for up to 4 GHz with 50  $\Omega$  coupling or up to 1 GHz for 1 M $\Omega$  coupling (depending on the exact model purchase).

### ***ProLink Probe Interface***

The ProLink interface contains a 6-pin power and communication connection and a Blind Mate Adapter (BMA) signal connection to the probe. It offers 50  $\Omega$  input impedance and provides probe power and control for a wide range of probes with bandwidth ratings from 3 GHz to 20 GHz. The nature of the ProLink interface with its recessed BMA connector means that an adapter must be connected to the ProLink interface to allow SMA or 2.92/K connector terminated cables to be attached to the oscilloscope channel. These adapters are normally provided with your oscilloscope, and are described in *ProLink Interface Adapters* (on page 22).

### ***2.92 mm and 2.4 mm Probe and Cable Interfaces***

Teledyne LeCroy's highest bandwidth oscilloscopes utilize a 2.92mm (up to 36 GHz) or a 2.4mm (up to 45 GHz) probe interface. This interface consists of a precision connector and a LEMO power and communication connector. It offers 50  $\Omega$  input impedance only.

For more information, refer to *Dual Channel Acquisition* in the online help.

WaveMaster 8 Zi / Zi-A models use 2.92 mm inputs for the 20 - 36 GHz signal inputs and 2.92 mm inputs for the 25 - 36 GHz signal inputs. These inputs are enabled using Digital Bandwidth Interleave (DBI), and they are contained in the Channel 2 and 3 locations in the ProBus (B) row for the 825Zi-A and 830Zi-A models.

Enable the 2.92 inputs for DBI from the Timebase dialog. Refer to *Timebase Overview* (on page 40) for more details. WaveMaster 845Zi-A units use 2.4 mm inputs for the highest bandwidth (45 GHz) signal input.

This bandwidth is only available on channel 3, and the input is enabled similarly to the 2.92 mm inputs.

The 2.92 mm and 2.4 mm high-bandwidth electrical paths are comprised of two connector halves/subassemblies which have a common mating interface. The first connector half is mounted into the oscilloscope connector panel. The outer end of this connector has a combination of

## WaveMaster 8 Zi/Zi-A Oscilloscopes

---

grooves, external threads and a coaxial interface with either a 2.4 mm (45 GHz) or 2.92 mm (up to 36 GHz) airline geometry. The second connector half has a similar interface on one end, with spring biased inner and outer contacts. It has corresponding projections which interlock with slots on the first connector half and a coupling nut which secures the two connector halves; resulting in a non-rotational, torque independent electrical connection. The spring biased inner and outer contacts eliminate the need for specifying proof torque and no tools are required to mate or un-mate the connection. This solution is commonly referred to as a connector saver and is easily and quickly field replaceable, should damage occur, making it a more field reliable system. The 2.92 mm connector savers operate mode free well beyond 36 GHz and the 2.4 mm connector saver operates mode free well beyond the maximum 45 GHz rating.

**Note:** The mating interface on the oscilloscope channel for both the 2.92 mm and 2.4 mm connector savers look identical, so be sure to connect the correct connector saver that corresponds to that physical oscilloscope channels maximum bandwidth rating if your oscilloscope model supports higher bandwidth ratings on one channel compared to others.

## ProLink Interface Adapters

For some instruments, Teledyne LeCroy's ProLink Adapters (LPA) provide the ability to connect a cable to your oscilloscope that is either BNC, SMA, or K (2.92 mm) terminated. These adapters are only for cable connection since they do not provide the power and communication interfaces required for probe usage. In fact, the absence of these connections on the adapters means that a probe cannot be connected to the oscilloscope when one of these adapters is connected.

The following cable connections are supported:

- BNC, using the LPA-BNC Blind Mate Adapter (BMA) to BNC interface adapter. This is not normally provide with your oscilloscope, but may be ordered as an accessory.
- SMA , using the LPA-SMA BMA-to-SMA adapter
- K-Type (2.92 mm), using the LPA-K BMA-to-2.92 mm adapter (4 are sent standard in 13 - 45 GHz units).

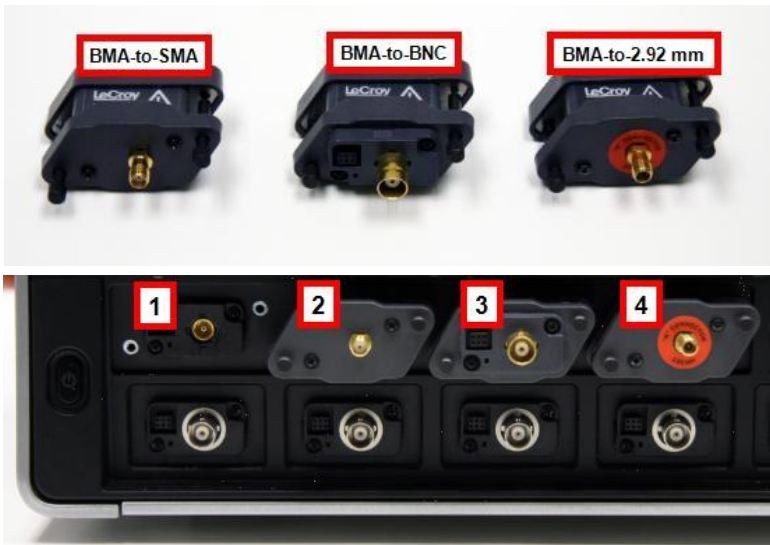

*First, the BMA Female Connector (1). Then, shown installed are the ProLink LPA-SMA, LPA-BNC, and LPA-K Adapters (2, 3, and 4).*

**Note:** When connecting an active probe to the instrument, an adapter is not required unless you wish to connect a ProBus compatible probe to a ProLink input.

## Connecting the Adapters

The mating end of the ProLink adapter has four fastening clips (shown right).



When installing an adapter on the instrument's connector panel, align the male 6-pin connector with the female connector and push the adapter straight forward. You are likely to notice some resistance and hear clicks as the four clips snap into place. Now, tighten the captive screws.

When removing an adapter, loosen the two captive screws. Push down on the adapter to unseat the clips. This requires some force and is initially noisy; however, no damage results to the connector, the floating female BMA connector, or the pins, as they can accommodate 15 degrees off axis while mated or unmated.

### ProLink Probe Adapters

ProLink Probe Adapters differ from ProLink Interface Adapters in that they contain a probe power and communication pass-through that the interface adapters do not have.

Currently, only one probe adapter is available, the LPA-2.92 mm. This device is used to allow attachment of a probe platform/cable assembly designed for connection to a 2.92 mm Probe Connection Interface to be connected to a ProLink input connection. For instance, this could be used to connect a 25 GHz probing system using 2.92 mm and LEMO connections for connection to a ProLink input.



Connecting the ProLink Probe Adapter is done in a similar way as connecting a ProLink Interface Adapter.

### Probes

Teledyne LeCroy offers a variety of passive and active probes for use with your X-Stream oscilloscope. Visit [teledynelecroy.com](http://teledynelecroy.com) for specifications and ordering information.

- **Current Probes** - Current Probes measure the current passing through a wire; current probes do not use the traditional probing style of placing a tip onto a test point. Instead, a wire is placed inside the jaw of the probe, which allows the probe to measure the current (in Amps).
- **Active Probes** - There are two different types of active probes: **single-ended** and **differential**.

*Single-Ended* - A single-ended active probe is associated with measuring voltages at high frequencies. Measurement with an active probe requires a test point and a ground point. The ground (also



called earth) acts as a zero reference for the test point measurement.

*Differential Probes* - Differential active probes are like two probes in one. Instead of measuring a test point in relation to a ground point (like single-ended active probes), differential probes measure the difference in voltage of a test point in relation to another test point.

- **Passive Probes** - Passive probes measure voltages at lower frequencies (<500 MHz). They have higher input capacitance (input C) and do not need power to operate (unlike active probes). At higher frequencies, higher input capacitance loads the test circuit, attenuating the signal. This is why active probes are used in high frequency applications. Passive probes also measure voltage in reference to ground.
- **High Voltage Probes** - These are active, single-ended probes designed to safely measure high voltages. They measure the voltage in reference to ground.

## Passive Probe Compensation

Passive probes must be compensated to flatten overshoot. This is accomplished by means of a trimmer at the connector end of the probe.

1. Attach the connector end of your passive probe to any channel.
2. Connect the probe end to the CAL output connector at the front of the oscilloscope. Ground the probe.
3. Adjust the trim pot at the connector end of the probe until the square wave is as flat as possible.

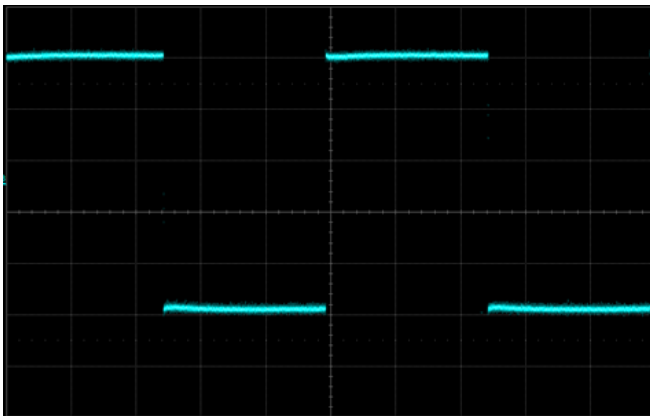

## Display

### Screen Layout, Groupings, and Controls

The instrument's screen is divided into the following main sections:

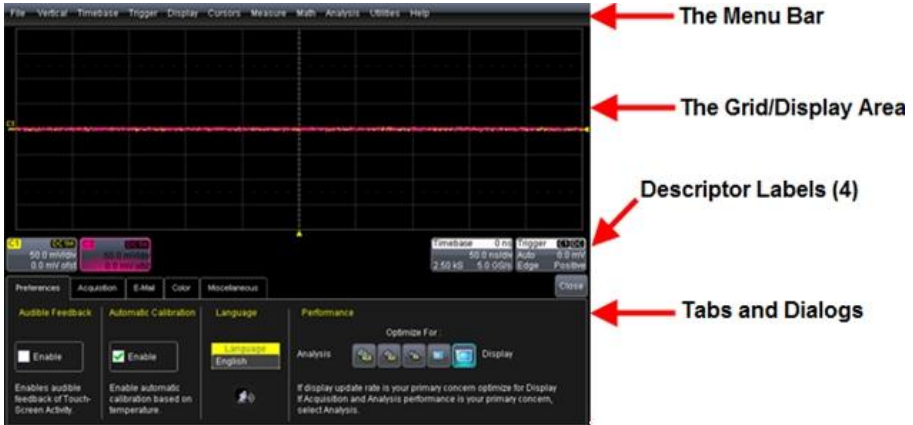

**Note:** Many front panel controls directly correspond with screen layout controls. For example, the Print front panel general control button corresponds with the Hardcopy function set from Utilities → Utilities Setup → Hardcopy.

## Menu Bar

The top of the screen contains a menu bar of commonly used functions. Whenever you touch one of these buttons and make a selection from its drop-down menu, the dialog area at the bottom of the screen displays the corresponding dialog.

Throughout this manual, Menu Bar selection paths are shown separated with arrows, for example: File → Save Setup...

### PLEASE NOTE THE FOLLOWING:

For common oscilloscope operations, you don't need to use the top menu bar (since you can access most dialogs from the Front Panel or from the Descriptor Labels). However, it is the only way to access setup or other dialogs for Display Setup, Save or Recall Waveform, Save or Recall Setups, Print Setup, Vertical (Channel), Horizontal, or Trigger Status, Memory (Reference Waveform) Setup, Pass/Fail Setup, or Utilities and Preferences Setup....

## The Quick Access Toolbar

The Quick Access portion of the toolbar is located on the right side of the menu bar. It contains the Rotate Display button.

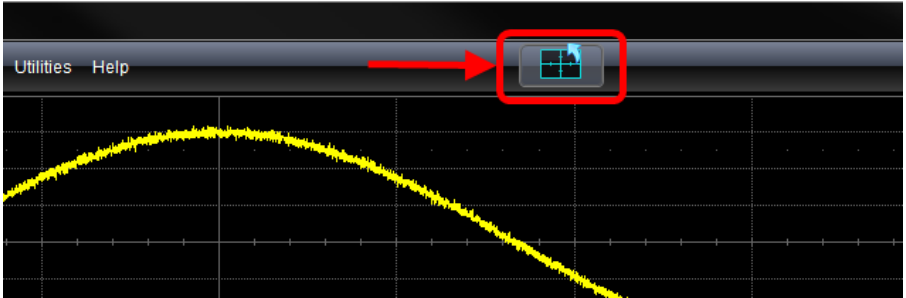

When the display is rotated, touch this button to adjust the user interface to a portrait layout. The button toggles from portrait layout back to landscape.

For additional information on rotating and tilting the display, refer to *Hardware and Software Controls* (on page 11).

## The Signal Display Grid

The grid area is divided into 8 vertical divisions and 10 horizontal divisions just like any other oscilloscope. Set up the signal display area by touching **Display** → **Display Setup...** from the menu bar. The **Display** dialog offers a choice of grid combinations and can also set the grid intensity.

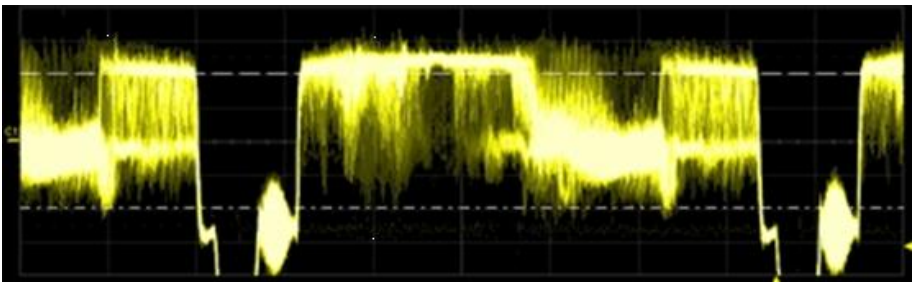

## WaveMaster 8 Zi/Zi-A Oscilloscopes

There are several indicators on the grid to help you understand the following:

- **Trigger Delay** - This indicator is located along the bottom edge of the grid. Trigger delay allows you to see the signal prior to the trigger time.

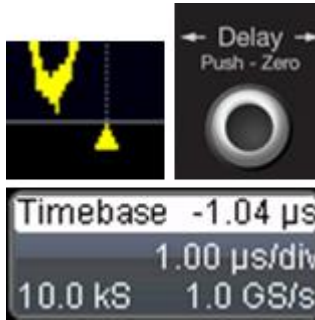

All trigger delay values (including post-trigger delay, shown here) are displayed in the Timebase Descriptor Label. Zero delay is the horizontal center of the oscilloscope display.

The default setting (Time) is for delay readout (in seconds) and to move proportionately when the timebase knob is turned. If you want to set delay (Div) to a fixed position on the grid, and then have it stay fixed as the timebase changes, go to Utilities → Preference Setup... and select the Acquisition dialog to make the setting.

- **Post-trigger Delay** - This is indicated by a left-pointing arrow to the lower-left of the grid. Pre-trigger delay is indicated by a right-pointing arrow to the lower-right of the grid.

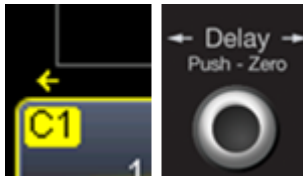

- **Trigger Level** - This indicator is located at the right edge of the grid. It tracks the trigger level as you reposition the trace up or down, or change scale. When triggering is stopped, a hollow arrow indicates where the new level ends up when triggering resumes.

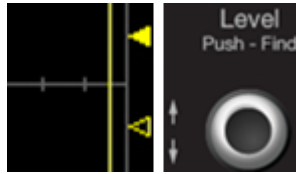

Push the LEVEL knob to reset the level to 50%.

- **Zero Volts Level** - This indicator is located at the left edge of the grid. Change the zero volts level by turning the vertical **OFFSET** knob. Push the knob to reset the indicator to the middle of the grid.

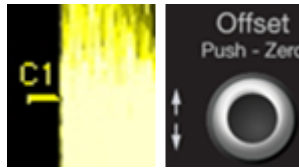

## Signal Display Grid Pop-Up Menu

On the Signal Display Grid, the Pop-up menu provides assistance while using the oscilloscope.

Clicking on a waveform opens a pop-up menu. From this pop-up menu, you can perform the following functions:

- Open the Setup dialog for the trace
- Turn the trace descriptor label off
- Open the Math dialog for the trace
- Open the Measure dialog for the trace
- Annotate the selected trace

## Trace Descriptor Labels

Shown just beneath the grid display, these boxes provide a summary of your channel, timebase, and trigger settings.

When a trace is selected its corresponding descriptor label is shown highlighted.



*The C1 Trace Descriptor Label is selected; C2 is not.*

## WaveMaster 8 Zi/Zi-A Oscilloscopes

Make vertical or horizontal channel adjustments by touching the respective label. The setup dialog for the function is shown beneath.

Channel trace labels show the vertical settings for the trace and cursor information (if cursors are in use). The title bar of the label includes indicators for (SinX)/X interpolation, waveform inversion (INV), deskew (DSQ), coupling (DC/GND), bandwidth limiting (BWL), and averaging (AVG).

These indicators have a long and short form.

| Pre-processing     | Long Form Indicator | Short Form Indicator |
|--------------------|---------------------|----------------------|
| Averaging          | AVG                 | A                    |
| Interpolation      | SINX                | S                    |
| Inversion          | INV                 | I                    |
| Deskew             | DSQ                 | DQ                   |
| Coupling           | DC                  | D                    |
| Ground             | Gnd                 | G                    |
| Bandwidth Limiting | Bwl                 | B                    |

Besides channel traces, math and parameter measurement labels are also displayed. Labels are displayed only for traces that are turned on.

Vertical and horizontal trace descriptor (labels) are displayed below the grid. They provide a summary of your channel, timebase, and trigger settings. Make vertical or horizontal channel adjustments by touching the respective label. The setup dialog for the function is shown beneath.

**TimeBase** trace descriptor labels show the trigger delay setting, time per division, and sampling information.

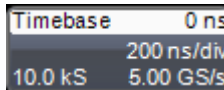

**Trigger** trace descriptor labels show the trigger mode (Auto, Normal, or Stopped). It also shows the coupling (DC), trigger type (Edge), source (C1), level (0 mV), and slope (Positive).

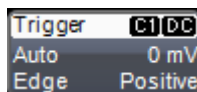

Setup information for horizontal cursors, including the time between cursors and the frequency, is shown beneath the TimeBase and Trigger trace descriptor labels.

```
X1= 1.36735  $\mu$ s   $\Delta$ X= 531.07 ns  
X2= 1.89842  $\mu$ s  1/ $\Delta$ X= 1.88299 MHz
```

### Shortcut Toolbar Buttons

You can access the same functions available from the Signal Display Grid Pop-Up menu by clicking a trace-descriptor label and using the toolbar of buttons at the bottom of the setup dialogs.

For more information, see the Shortcut Toolbar Buttons section of *Dialog Area* (on page 33).

### Annotating Traces

The instrument gives you the ability to add an identifying label, bearing your own text, to a waveform display:

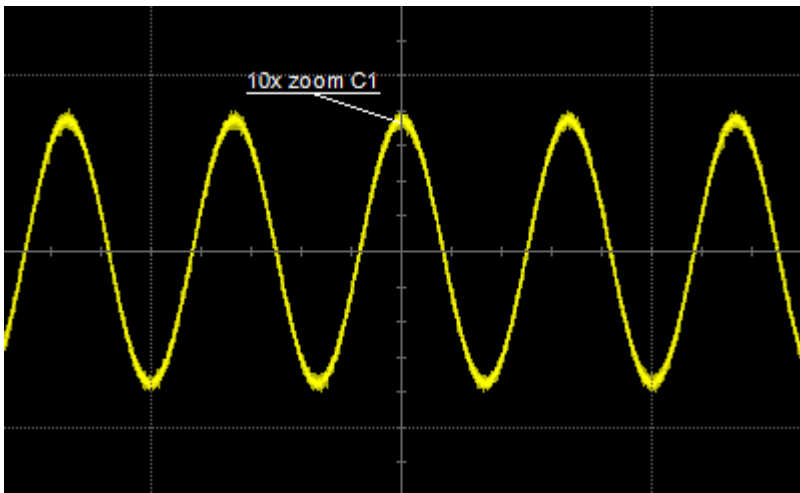

For each waveform, you can create multiple labels and turn them all on or all off. Also, you can position them on the waveform by dragging or by specifying an exact horizontal position.

Touch the waveform you want to annotate right on the display grid, and then touch Set label... on the pop-up menu. A dialog box opens in which to create the label. The first time creating a waveform label, Label1 is provided as default text when the Add label button is touched.

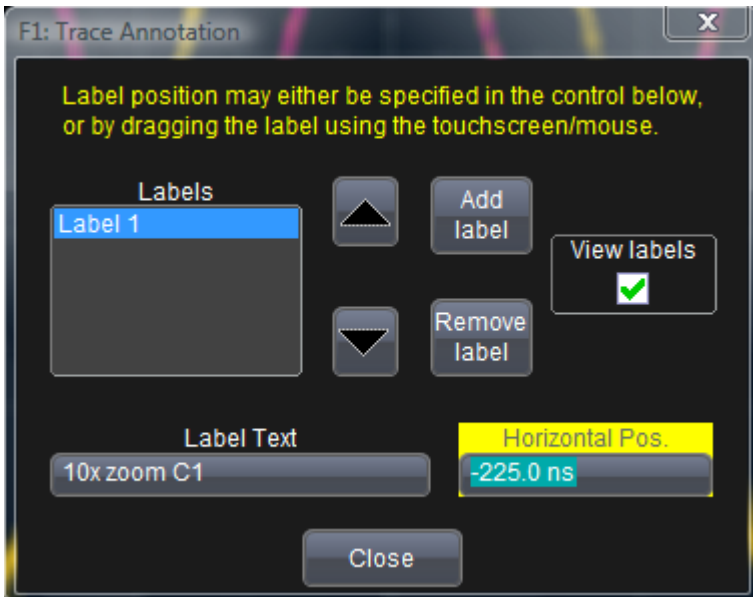

From this pop-up you can edit existing annotations, change the label placement on the waveform, add labels, remove labels, and toggle the visibility. The following bullets show you how.

- If you are modifying an existing label, under Labels touch the label you want to change.

**Note:** If the dialog for the trace you want to annotate is currently displayed, you can touch the label button at the bottom to display the Trace Annotation setup dialog.

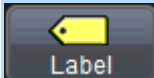

You may place a label anywhere you want on the waveform. Labels are numbered sequentially according to the order in which they are added, and not according to their placement on the waveform.

- If you want to change the label's text, touch inside the **Label Text** field. A pop-up keyboard appears for you to enter your text. Touch **O.K.** on the keyboard when you are done. The edited text automatically appears in the label on the waveform.
- Precisely place the label by touching inside the **Horizontal Pos.** field and provide a horizontal value, using the pop-up numeric keypad.



- Add another label by touching the **Add label** button. Delete a label by selecting the label from the list, and then touching the **Remove label** button.
- Make labels visible by touching the **View labels** checkbox.

## Dialog Area

The lower portion of your oscilloscope screen is where information is shown, selections are made, and data is input. These screens are organized into tabular displays, subtabs, or pop-up dialogs. The dialog area is controlled by Touch Screen Controls and Front Panel Controls.

### Touch Screen Controls

Various touch screen user interface controls are provided for easily entering data. Their functionality is described in this topic and you'll see them referenced throughout the documentation.

#### POP-UP SELECTORS

When Pop-Up selector controls are touched, sometimes a very small box is shown right inside the control - as in the Coupling selector on the C1 dialog.



*Pop-Up Selector Control for smaller values.*

Other times, a larger box is shown after touching a control. This larger Pop-Up has categorical buttons along the left column along with labels (and sometimes descriptions) for the selectable entry values.

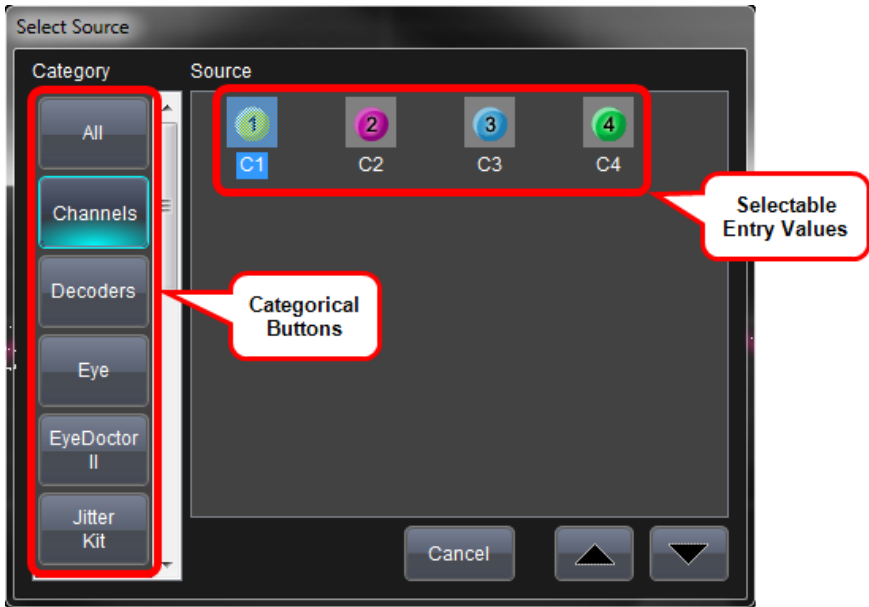

*Pop-Up Selector Control for values with varied types.*

## TEXT ENTRY FIELDS

Most fields can be touched once and you can then provide a value using an attached (or double-touch/click to use the Virtual, on-screen) keyboard.

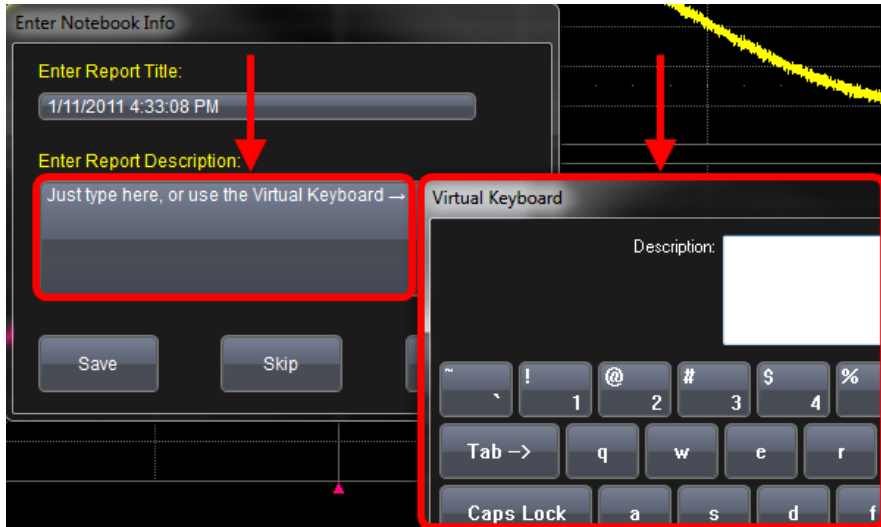

*Text entry field for LabNotebook using the Virtual Keyboard.*

## FOLDER/FILE NAVIGATION TREES

These controls allow for navigation to or from folders (on the hard drive or memory device) for retrieving or storing items such as waveforms, LabNotebook entries, to name a few.

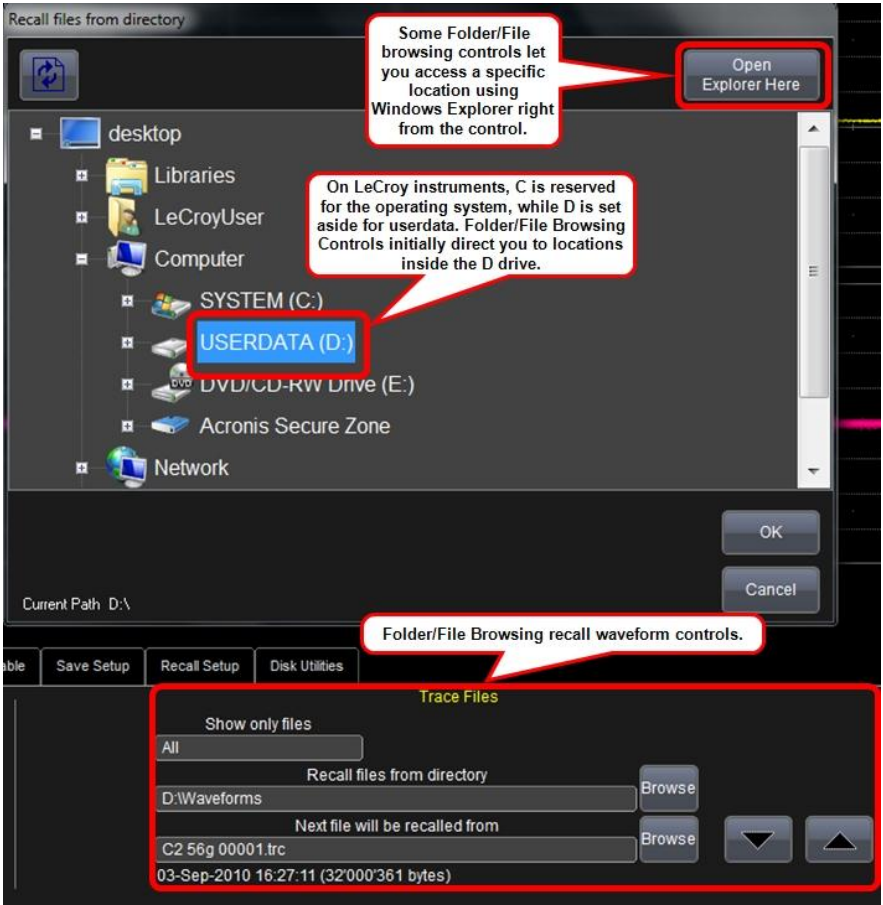

*The Recall waveform navigation tree.*

**Note:** The instrument's hard disk is partitioned into drive C: and drive D:. Drive C: contains the Windows operating system and the instrument application software. Drive D: is intended for data files.

## FLYOUT MENUS

Flyout Menus provides a variety of solutions for a particular main area of functionality. It does this by providing a set of buttons subdividing the control into more specific functions on the right-side of the display.

# WaveMaster 8 Zi/Zi-A Oscilloscopes

An example of Flyout Menu Controls is seen in the **Setup** front panel button.



*Setup Flyout Menu control.*

## PRECISION DATA ENTRY CONTROLS

Certain fields requiring precise value entry assist you by having precision entry means. When these controls are selected, you can provide values as follows:

### Keyboard

Touch inside a text entry control and you can manually type the value in using an attached (or double-touch/click to use the Virtual, on-screen) keyboard.

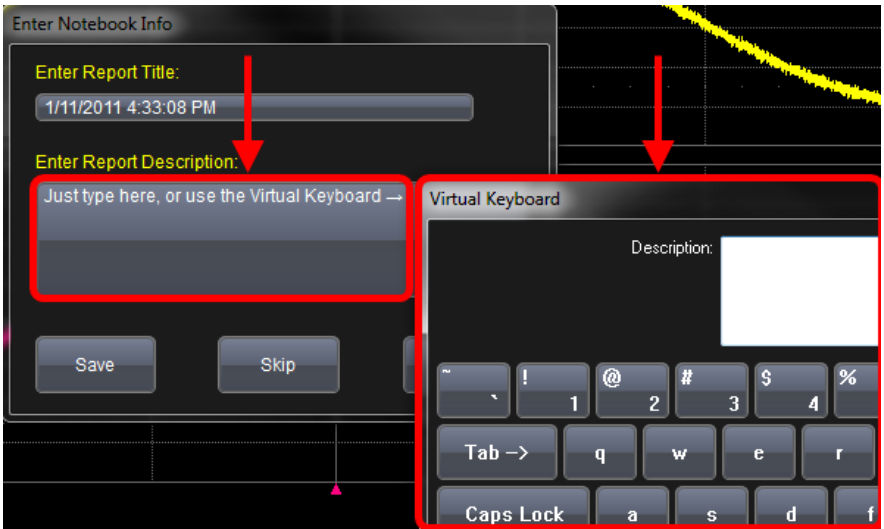

*Text entry field for LabNotebook using the Virtual Keyboard.*

## Slider Bar

Some models provide what is known as a **Slider Bar** along the bottom of the screen **when a keyboard is attached** to the instrument. The Slider Bar allows you to select your entered value by moving a horizontal slider (left to right provides low to high amounts).



## Pop-Up Keypad

Some models provide a pop-up Keypad when you touch twice in the same control. A keypad button is also provided on the slider bar (on models that have the slider bar) which shows the pop-up keypad when touched.

For many controls, once the Pop-Up Keypad is shown the **Front Panel Controls** (on page 11) can be used to adjust the value in the pop-up. The Pop-Up contains **Up** and **Down** arrow buttons, **Set to Max**, **Default**, and **Min** buttons, and the **Keypad** itself for providing your value.

The slider bar also has a handy default value button for quickly entering the default for the control.



## WaveMaster 8 Zi/Zi-A Oscilloscopes

Default and Keypad Buttons on the Slider Bar are only shown on 7, 8, and 9 Zi models (with a keyboard attached).

### Shortcut Toolbar Buttons

Several dialogs contain common functions accessible from a row of buttons along the bottom of the main setup dialogs.

For example, these buttons at the bottom of the Channel Setup dialog perform the following functions:



- **Measure** - Opens the Measure menu. You can then select a parameter from this menu without leaving the Channel Setup dialog. The parameter automatically appears below the grid.
- **Zoom** - Creates a zoom trace of the channel trace whose dialog is currently displayed.
- **Math** - Opens the Math menu. You can then select a math function from this menu without leaving the Channel Setup dialog. A math trace of the channel whose dialog is currently open is automatically displayed.
- **Decode** - Opens the main Serial Decode dialog where protocol option measurements can be applied to signals.
- **Store** - Loads the channel trace into the next available memory location (M1 to M4).
- **Find Scale** - Automatically performs a vertical scaling that fits the waveform into the grid.
- **Next Grid** - Automatically moves the channel trace whose dialog is currently open onto the next grid. If you have only one grid displayed, a new grid will be created automatically, and the trace moved.

**Note:** This button is not available on all oscilloscope models.

- **Label** - Enables you to attach identifying labels to your waveforms. The labels are preserved when the waveform is saved as a LabNotebook entry and when saved to file.

- **Probe Cal - Cable Deskew** - Opens the Probes Cal. dialog where various Gain, Offset, Skew, Source, and Advanced controls are available for probe signal calibration.

Another example is seen in the buttons appearing at the bottom of the Measure **Px** dialogs. The button may be selected in order to display the functions named on the buttons (sometimes labeled as **Actions**):

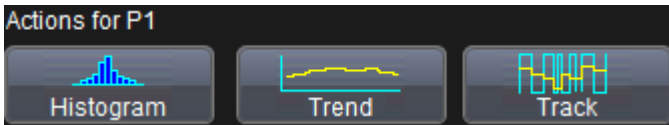

*Shortcut buttons on the Cx dialog.*

Using these buttons allow you to remain in the Measure dialog while setting up a Math trace on a parameter measurement.

## Message Bar

At the bottom of the oscilloscope display is a narrow message bar. The current date and time are displayed at the far right. Status, error, or other messages are also shown in this area.

## Turning on Channels and Traces

### PLEASE NOTE THE FOLLOWING:

- If you want to display each trace on its own grid automatically, enable Autogrid by touching Display → Autogrid from the menu bar.
- You can turn channels on and off using the software, for more information see Vertical Overview (on page 54)
- On the front panel, press a channel select button to display the trace descriptor label for that input channel and turn on the channel.
- Turn on a math function trace by touching Math → Math Setup... from the menu bar. Touch the corresponding On checkbox to activate the desired trace.
- You can also quickly create traces (and turn on the trace label) for math functions and memory traces, without leaving the Vertical Adjust dialog, by touching the icons at the bottom of the Vertical Adjust dialog.

# WaveMaster 8 Zi/Zi-A Oscilloscopes



Whenever you turn on a channel, math, or memory trace using either the menu bar or trace descriptor label, the dialog at the bottom of the screen automatically switches to the vertical setup or math setup dialog for that selection.

You can configure your traces from here, including math setups.

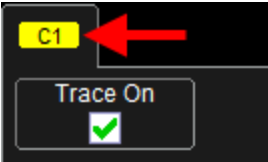

The Trace Dialog is shown on the lower portion of the screen. The tab is labeled with the corresponding channel number as follows:

## Timebase

### Overview

You can access Timebase settings using the front panel Horizontal controls, the Timebase → Horizontal Setup... on the menu bar, or by touching the Timebase trace descriptor label. The main Timebase dialog is then shown and contains sections for Sampling Mode, Timebase Mode, and Real Time Memory.



A section specifically used for combining channels is located on the far right of the main Timebase dialog. This section varies based on your oscilloscope model.

### Timebase Setup and Control

1. With the Timebase dialog showing, touch inside the **Time/Division** data entry control and provide a value.
2. Touch inside the **Delay** data entry control and provide a value.



## Combining Channels

Channels can be combined to increase sample rate, memory, and bandwidth. When you combine channels, the remaining (uncombined) channels are available for triggering, even though they are not displayed as active on the screen.

Channels are combined in either of two ways depending on your WaveMaster 8 Zi / Zi-A oscilloscope model.

- Internally, using Digital Bandwidth Interleaving (DBI) on a 20 - 30 GHz 8 Zi unit or a 25 - 45 GHz 8 Zi-A unit.
- Using an External Interleaving Device on a 4 - 16 GHz 8 Zi unit or a 4 - 20 GHz 8 Zi-A unit. Learn more by referring to *Using the External Interleaving Device* in your online help or on [teledynelecroy.com](http://teledynelecroy.com).

### Using Digital Bandwidth Interleave (DBI)

Digital Bandwidth Interleave is a method for combining channels to double bandwidth - just as oscilloscope manufacturers have for years interleaved channels to double sample rate and memory lengths. Teledyne LeCroy's 8 Zi-A series makes use of 6th generation DBI technology providing the highest possible performance.

Enter DBI mode from the TimeBase dialog at **TimeBase → Horizontal Setup...**

For 25 and 30 GHz models (and additionally, the 20 GHz 8 Zi and Zi-A model), the DBI portion of the TimeBase dialog contains buttons for **C1/C2** and **C3/C4**.

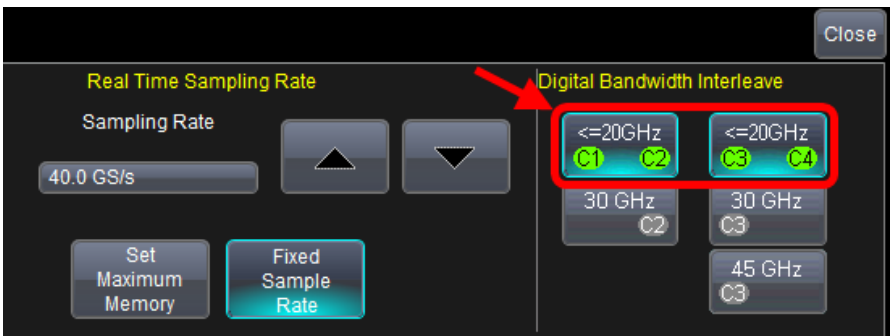

A pop-up is shown when using the DBI button controls verifying the proper connector saver (2.92 mm or 2.4 mm for 45 GHz).

## WaveMaster 8 Zi/Zi-A Oscilloscopes

Check **Don't Show Me This Message Again** to avoid subsequent warnings.

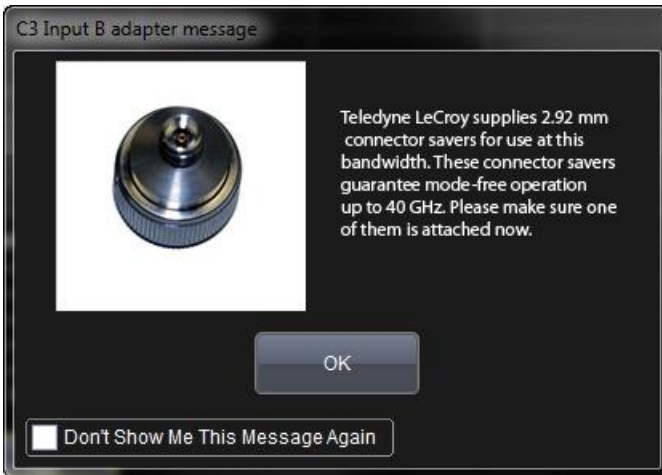

*The 2.92 mm connector saver pop-up.*



*The 2.4 mm connector saver pop-up.*

When selected, the respective channels are combined into one channel at higher bandwidth. The 45 GHz model contains a button to combine all four channels into one (C3) channel at 45 GHz bandwidth.

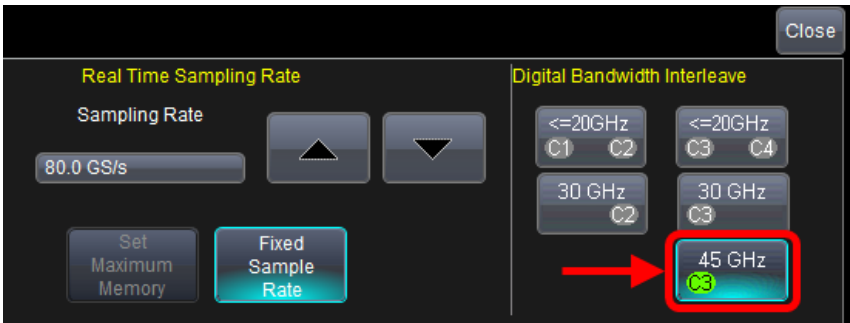

## PLEASE NOTE THE FOLLOWING:

- For 25 or 30 GHz models, you may elect to combine one or both pairs of channels.
- Combined channel buttons have a 30 or 45 GHz label depending on your model. When these buttons are selected, the channel pair (or group on 45 GHz models) is dedicated to achieving that level of bandwidth throughput together. However, sampling rate for each channel remains  $\leq 40$  GS/s.

On 25 and 30 GHz models, DBI enabled C2 and C3 traces achieve:

- 25, or 30 GHz (depending on your model)
- 80 GS/s
- Interleaving of the memory to 512 Mpts/Ch

On 45 GHz models, DBI can be enabled in two channel mode to achieve performance identical to that of the 30 GHz model, or it can be enabled on the C3 trace to achieve:

- 45 GHz
- 120 GS/s
- Interleaving of the memory to 768 Mpts

When DBI is selected, trace descriptor labels correspond with your choices. For example, when both **C1/C2** and **C3/C4** pairs are interleaved:

- **C1** - Shown as inactive
- **C2** - Shown as active
- **C3** - Shown as active
- **C4** - Shown as inactive

## WaveMaster 8 Zi/Zi-A Oscilloscopes

**Note:** After you've enabled DBI for C3 and/or C2, and corresponding trace dialogs are shown on the display, respective channel LED indicators are also lit on the front of the oscilloscope.

### DBI Settings

When you use DBI and make correct connections and channel selections from the **TimeBase → Horizontal Setup...** dialog, the system makes value changes for you.

- View these changes by touching the **trace descriptor label** for an interleaved channel (C2 or C3).
- The **Vertical Scale B Scale V/div** (Timebase) value is automatically set to **50 mV/div**. If you set this to a different value and deactivate DBI, the system retains the last one used when DBI is reactivated.
- The channel LEDs form the following configuration in **25 or 30 GHz mode**:

| Channel 1              | Channel 2             | Channel 3             | Channel 4              |
|------------------------|-----------------------|-----------------------|------------------------|
| OFF, No LED Light<br>▲ | Green Down Arrow<br>▼ | Green Down Arrow<br>▼ | OFF, No LED Light<br>▲ |

- The channel LEDs form the following configuration in **45 GHz mode**:

| Channel 1              | Channel 2              | Channel 3             | Channel 4              |
|------------------------|------------------------|-----------------------|------------------------|
| OFF, No LED Light<br>▲ | OFF, No LED Light<br>▲ | Green Down Arrow<br>▼ | OFF, No LED Light<br>▲ |

**Note:** When using DBI, use Channel 3 for high-speed serial triggering.

# Sampling Modes

## Overview

Depending on your timebase, you can choose **Single-shot Sampling Mode** (below), also known as Real Time mode, **Sequence Sampling Mode** (on page 46), or **RIS Sampling Mode** (on page 53) mode sampling.

Newer instruments offer **Roll Mode** (on page 54)

Some instruments also offer **Roll Mode** (on page 54).

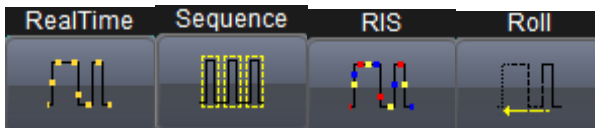

## Selecting a Sampling Mode

1. Touch **Timebase** → **Horizontal Setup...** from the menu bar.
2. In the **Timebase** dialog, touch a **Sample Mode** button.
3. If you chose **Sequence Mode**, touch the **Sequence** tab. The **Sequence** dialog is shown. Use the following controls to provide details for controls such as **Number of Segments**, **Enable Timeout**, **Timeout** (value), **Display Mode**, and **Show Sequence Trigger Times**.

## Single-shot Sampling Mode

A single-shot acquisition is a series of digitized voltage values sampled on the input signal at a uniform rate. It is also a series of measured data values associated with a single trigger event. The acquisition is typically stopped a defined number of samples after this event occurs: a number determined by the selected trigger delay and measured by the timebase. The waveform's horizontal position (and waveform display in general) is determined using the trigger event as the definition of time zero.

You can choose either a pre- or post-trigger delay. Pre-trigger delay is the time from the left-hand edge of the display grid forward to the trigger event, while post-trigger delay is the time back to the event.

## WaveMaster 8 Zi/Zi-A Oscilloscopes

---

You can sample the waveform in a range starting well before the trigger event up to the moment the event occurs. This is 100% pre-trigger, and it allows you to see the waveform leading up to the point at which the trigger condition was met and the trigger occurred. (The instrument offers up to the maximum record length of points of pre-trigger information.) Post-trigger delay, on the other hand, allows you to sample the waveform starting at the equivalent of 10,000 divisions after the event occurred.

On fast timebase settings, the maximum single-shot sampling rate is used. But for slower timebases, the sampling rate is decreased and the number of data samples maintained.

The relationship between sample rate, memory, and time can be simply defined as:

$$\text{Capture Interval} = 1/\text{Sample Rate} \times \text{Memory}$$

and

$$\text{Capture Interval}/10 = \text{Time Per Division}$$

## Sequence Sampling Mode – Working with Segments

Using Sequence Mode, thousands of trigger events can be stored as segments into the oscilloscope's memory (the exact number depends on oscilloscope model and memory options). This is ideal when capturing many fast pulses in quick succession or when capturing few events separated by long time periods. The instrument can capture complicated sequences of events over large time intervals in fine detail, while ignoring the uninteresting periods between the events. You can also make time measurements between events on selected segments using the full precision of the acquisition timebase.

Sequence mode offers a number of unique capabilities:

- You can acquire up to four channels simultaneously.
- You can minimize dead time between trigger events for consecutive segments.
- You can view time stamps for acquisitions.
- You can zoom segments or used them as input to math functions.

- You can combine sequence mode with an advanced trigger to isolate a rare event, capture all instances over hours or days, and view/analyze each afterwards.
- You can use Sequence mode in remote operation to take full advantage of the instrument's high data-transfer capability.

In Sequence mode, the complete waveform consists of a number of fixed-size segments acquired in single-shot mode (see the instrument specifications for the limits). The oscilloscope uses the sequence timebase setting to determine the capture duration of each segment as  $10 \times$  time/div. With this setting, the oscilloscope uses the desired number of segments, maximum segment length, and total available memory to determine the actual number of samples or segments, and time or points.

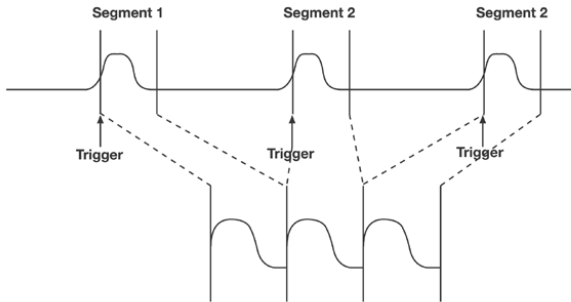

*How the instrument captures segments*

### **Sequence Display Modes**

The instrument gives you a choice of five ways to display your segments:

- **Adjacent**

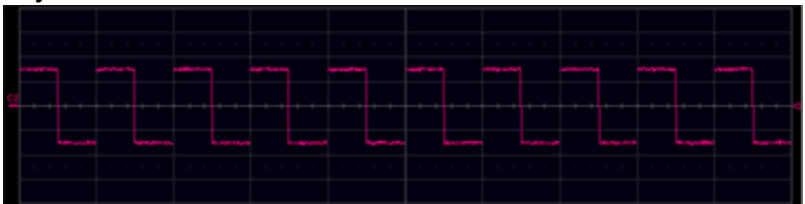

# WaveMaster 8 Zi/Zi-A Oscilloscopes

- Waterfall (cascaded)

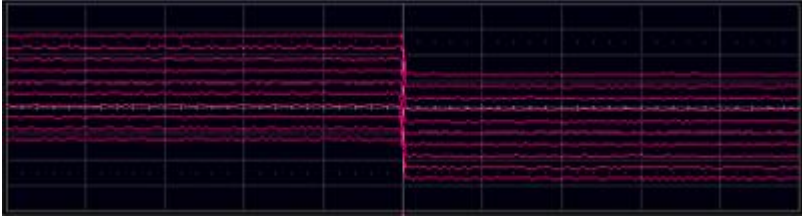

- Mosaic (tiled)

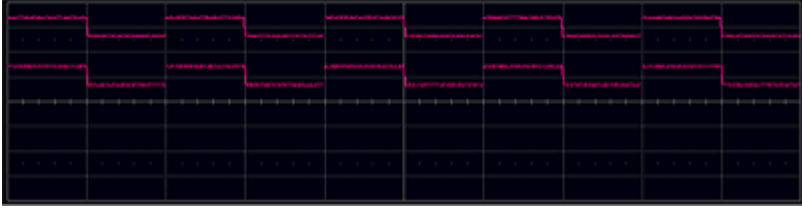

- Overlay

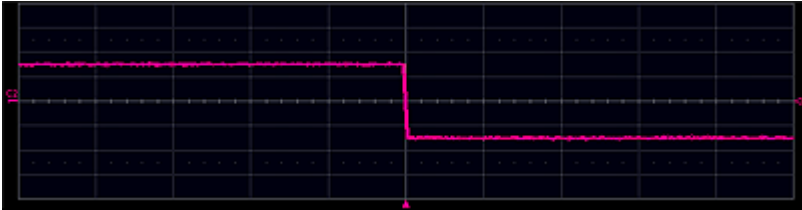

- Perspective

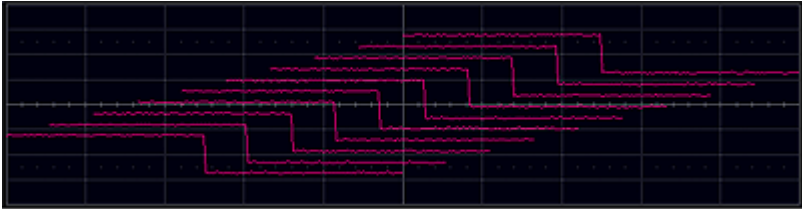

**Note:** some display modes have limitations on the number of segments that can be shown at one time.

## ***Sequence Mode Setup***

When setting up Sequence Mode, you define the number of fixed-size segments acquired in single-shot mode (see the instrument specifications for the limits). The oscilloscope uses the sequence timebase setting to determine the capture duration of each segment. Along with this setting, the oscilloscope uses the number of segments, maximum segment length,



and total available memory to determine the actual number of samples or segments, and time or points.



## Setting up Sequence Mode (Adjacent)

1. Touch **Timebase** → **Horizontal Setup...** on the menu bar.
2. Click the **Sequence** tab.
3. Under **Acquisition Settings**, touch inside the **Num Segments** data entry control and provide a value using your preferred input control method. Additional information on using the touch screen controls can be found in the **Dialog Area** (on page 33).

**Note:** The number of segments you choose to display can be less than the total number of segments in the waveform. For example, in the pop-up images above, the number of display segments is 10, but the total number of segments entered in the timebase dialog's **Num Segments** control is 100.

4. Touch the **Enable Timeout** checkbox.
5. Touch inside the **Timeout** data entry control and provide a timeout value.

**Note:** Use the sequence mode timeout to automatically interrupt the sequence acquisition if the timeout value is exceeded without a valid trigger. The timeout period accounts for instances when a **Num Segments** miscount occurs for some reason and the oscilloscope



1. Touch the front panel **Quickzoom** button.



2. Turn the **Zoom** front panel position knob to scroll through the segments.
3. To vary the degree of zoom, touch the newly created **Zx** trace label. The setup dialog for the zoom (Z1 to Z4) opens. It shows the current horizontal and vertical zoom factors.
4. If you want to increase or decrease your horizontal or vertical zoom in small increments, touch the **Var.** checkbox to enable variable zooming. Now with each touch of the **zoom control** buttons, the degree of magnification changes by small increments.



**OR**

If you want to zoom in or out in large standard increments with each touch of the zoom control buttons, leave the **Var.** checkbox unchecked.

**OR**

If you want to set exact horizontal or vertical zoom factors, touch inside the Horizontal **Scale/div** data entry control and enter a time-per-div value, using the pop-up numeric keypad. Then touch inside the Vertical **Scale/div** control and enter a voltage value.

# WaveMaster 8 Zi/Zi-A Oscilloscopes

## Displaying an Individual Segment

1. Touch **Math** → **Math Setup...** on the menu bar.
2. Touch a function tab **Fx** showing its corresponding dialog.
3. On the dialog, touch inside the **Operator1** control and select the **Segment** button from the pop-up menu.



4. In the dialog on the right, touch the **Select** tab.
5. Touch inside the **First Selected** data entry control and select the first segment you want to display. Use the same method to provide a value in the **Number of Selected** data entry control.

**Note:** In Persistence mode, the segments are automatically overlaid one on top of the other in the display. In non-Persistence mode, they appear separately on the grid.

## Viewing Time Stamps

You can view time stamps for each segment.

You can view Time Stamps for Segments in Sequence Mode.

| Seg | Time                  | since Segment 1 | between Segment |
|-----|-----------------------|-----------------|-----------------|
| 1)  | 24-June-2008 18:37:53 |                 |                 |
| 2)  | 24-June-2008 18:37:53 | 5.063452 ms     | 5.063452 ms     |
| 3)  | 24-June-2008 18:37:53 | 37.581684 ms    | 32.518232 ms    |
| 4)  | 24-June-2008 18:37:53 | 43.956545 ms    | 6.364861 ms     |
| 5)  | 24-June-2008 18:37:53 | 48.729098 ms    | 5.062452 ms     |
| 6)  | 24-June-2008 18:37:53 | 81.216419 ms    | 32.486321 ms    |
| 7)  | 24-June-2008 18:37:53 | 87.370269 ms    | 6.153850 ms     |
| 8)  | 24-June-2008 18:37:53 | 92.432672 ms    | 5.062298 ms     |
| 9)  | 24-June-2008 18:37:53 | 124.948144 ms   | 32.471572 ms    |
| 10) | 24-June-2008 18:37:53 | 131.080758 ms   | 6.178914 ms     |

View Segment Time Stamps



# WaveMaster 8 Zi/Zi-A Oscilloscopes

**Note:** RIS mode is not available when the oscilloscope is operating in **fixed sample** or DBI 25 - 45 GHz) modes as covered in **Smart Memory** (available in the online help files) and **Combining Channels** topics, respectively.

## Roll Mode

Roll mode displays, in real time, incoming points in single-shot acquisitions that have a sufficiently low data rate. The oscilloscope rolls the incoming data continuously across the screen until a trigger event is detected and the acquisition is complete. The parameters or math functions connected to each channel are updated every time the roll mode buffer is updated, as if new data is available. This resets statistics on every step of Roll mode that is valid because of new data.

**Note:** If the processing time is greater than the acquire time, the data in memory gets overwritten. In this case, the instrument issues a **Channel data is not continuous in ROLL mode!!!** warning and rolling starts over again.

## Vertical Overview

You can access Vertical settings using the front panel **Vertical** controls, by selecting **Vertical**→ **Channel Setup...** on the menu bar, or by touching the Channel trace descriptor label. The following screen-shot shows the **C1 Vertical** dialog on a LabMaster as an example. For each channel, a corresponding **Vertical** dialog contains sections with respective controls.



1. **Channel Controls** (on page 55) let you set up individual channels.
2. **Actions for Trace C1 Buttons** (**Error! Bookmark not defined.**) let you perform certain actions on the channel, such as Math, Zoom, and Measure actions.
3. **Pre-Processing Controls** (on page 58) let you set up pre-process controls, such as cable de-embedding and interpolation.

## Channel Controls

The individual Channel Controls section of the dialog provides the following functions for your respective channel:

- **Channel Inputs** - For each channel, you can set the Channel Input to either Input A (Upper) or Input B (Lower). The Channel Row LED Indicators display which input is set for each channel.

**PLEASE NOTE THE FOLLOWING:**

- Not all oscilloscope models have Upper and Lower Channel Inputs. In those cases, no Selected Input buttons are provided.
- **Slave Acquisition Modules** indicate alternative, or B channels, on named LED indicators.
- **Vertical Scale** - For each channel, you can set the vertical scale or sensitivity and choose whether to use fixed or variable gain adjustment.
- **Vertical Offset** - For each channel, you can select between zero vertical offset or to set the offset to a specific value.
- **Coupling** - The maximum input voltage depends on the input used. Values are displayed on the front of the oscilloscope. Whenever the voltage exceeds this limit, the coupling mode automatically switches from DC 50  $\Omega$  to GROUND. You then have to manually reset the coupling to DC 50  $\Omega$ .



**CAUTION.** While the unit does provide this protection, damage can still occur if extreme voltages are applied

- **Bandwidth** - Bandwidth filters are available at the following levels: Full (all X-Stream oscilloscopes), 30 GHz, 25 GHz, 20 GHz, 16 GHz, 13 GHz, 8 GHz, 6 GHz, 4 GHz, 3 GHz, 1 GHz, 200 MHz (all X-Stream oscilloscopes), and 20 MHz (all X-Stream oscilloscopes).

**WaveMaster** - 45 GHz, 30 GHz, 25 GHz, 20 GHz, 16 GHz, 13 GHz, 8 GHz, 6 GHz, 4 GHz, 3 GHz, 1 GHz, 200 MHz, and 20 MHz.

**PLEASE NOTE THE FOLLOWING:**

- Each oscilloscope contains only the Full selection and those bandwidths less than the rated oscilloscope bandwidth.
- Anti-aliasing filters are applied to limit bandwidth at lower sample rates, regardless of bandwidth limit selection.

# WaveMaster 8 Zi/Zi-A Oscilloscopes

- **Probe** - Teledyne LeCroy's **ProLink**, and **2.92 mm** systems automatically senses probes and sets their attenuation for you. For each channel, the probe attenuation can also be set manually.



## Setting Up Channels

1. Touch **Vertical** → **Channelx Setup...** from the menu bar.
2. Touch inside the **Trace On** checkbox to display the trace.
3. On pertinent model oscilloscopes, under **Selected Input**, touch the **Input A (Upper)** button or **Input B (Lower)** button. Otherwise, no Selected Input buttons are provided.
4. Turn the **VERTICAL GAIN** front panel knob for the selected channel.

### OR

Touch inside the **Volts/Div** field and enter a value. Click the **keypad** button to enter a value using the pop-up keypad, or use the up/down arrows.

The set voltage is shown on the trace descriptor label and in the Volts/Div field in the dialog.

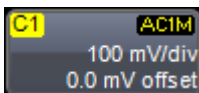

5. Turn the **VERTICAL OFFSET** adjust front panel knob directly above the channel button whose waveform you want to move vertically. Or you can touch inside the **Offset** field and type in a value on the pop-up keypad. To set the vertical offset to zero, touch the **Zero** button directly below the **Offset** field.
6. Touch inside the **Coupling** control and select a coupling mode from the pop-up menu.
7. Touch inside the **Bandwidth** control and provide a Bandwidth Limit value using your preferred input control method. Additional information on using the touch screen controls can be found in the **Dialog Area** (on page 33).



8. Touch inside the **Probe Atten.** data entry control if you want to set the attenuation manually, and provide a value using your preferred input control method. Additional information on using the touch screen controls can be found in the **Dialog Area** (on page 33).

## Shortcut Toolbar Buttons

Shortcut Toolbar buttons provide quick access to various functions for your respective channel. The following functions are available:



- **Measure** - Turn on a Measurement trace. Choose a measurement parameter from the Measurement pop-up window to determine a wide range of waveform properties. For example, you can use measurement parameters to automatically calculate many attributes of your waveform, like rise-time, rms voltage, and peak-to-peak voltage.
- **Zoom** - QuickZoom automatically displays a zoom of the channel or trace on a new grid.
- **Math** - Turn on a Math trace. Choose a Math function from the Math pop-up window.
- **Decode** - Shows the main Decode dialog.
- **Store** - Transfers the current trace into a corresponding memory trace.
- **Find Scale** - Automatically calculates peak-to-peak voltage, and chooses an appropriate Volts/Div scale to fully display the waveform.
- **Next Grid** - This button transfers a copy of your waveform into another grid. If another grid is not showing, the system creates a new grid for you.

**Note:** This button is disabled while using Auto Grid.

- **Label** - Shows the Trace Annotation pop-up where you can provide label text and positioning information.

## Pre-Processing Controls

Pre-Processing is meant as before Math processing. Pre-Processing controls provide the following functions for your respective channel:

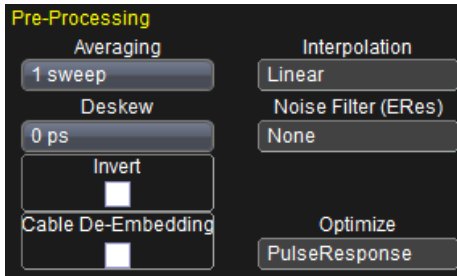

- **Averaging** - Specifically performs continuous averaging or the repeated addition, with unequal weight, of successive source waveforms. It is particularly useful for reducing noise on signals drifting very slowly in time or amplitude. The most recently acquired waveform has more weight than all the previously acquired ones: the continuous average is dominated by the statistical fluctuations of the most recently acquired waveform. The weight of old waveforms in the continuous average gradually tends to zero (following an exponential rule) at a rate that decreases as the weight increases.
- **Deskew** - Adjusts the horizontal time offset by the amount entered. The valid range is dependent on the current timebase setting. Pre-processing deskew and the Math deskew function perform the same activity.
- **Invert** - Invert the waveform for the selected channel.
- **Cable De-Embedding** - When making measurements on serial data signals, losses in the cables used in the test setup can reduce the accuracy of your signal (for example, signal amplitude and risetime), as well as introduce Inter-Symbol Interference. These cable effects can dramatically alter your serial data measurements and potentially create mask test violations.

The Cable De-Embedding option allows you to quickly specify the characteristics of the cables (typically found on the cable's data sheet) in your test setup and analyze your signal with the effects of the cables removed.

**Note:** The **Cable De-Embedding** checkbox is only available if you have the option. Learn more about this software option and **Contact Teledyne LeCroy for Support**.

- **Interpolation** - Linear interpolation, which inserts a straight line between sample points, is best used to reconstruct straight-edged signals such as square waves.  $(\text{Sinx})/x$  interpolation, on the other hand, is suitable for reconstructing curved or irregular wave shapes, especially when the sample rate is 3 to 5 times the system bandwidth.
- **Noise Filter** - Enhanced Resolution (ERES) filtering increases vertical resolution, allowing you to distinguish closely spaced voltage levels. The tradeoff is reduced bandwidth. The functioning of the instrument's ERES is similar to smoothing the signal with a simple, moving-average filter. Use ERES on single-shot waveforms, or where the data record is slowly repetitive (when you cannot use averaging). Use it to reduce noise when your signal is noticeably noisy, but you do not need to perform noise measurements. It also may be used when performing high-precision voltage measurements: zooming with high vertical gain, for example.

## Response Optimization Modes

Frequency response and group delay of the oscilloscope contributes to the pulse response characteristics of the oscilloscope. By slightly adjusting these characteristics using digital signal processing, the characteristic response of the oscilloscope can be optimized for your specific application.

Frequency response is defined as the decrease in the magnitude response with respect to frequency. A fourth-order Bessel roll-off slightly attenuates the frequencies near the bandwidth rating of the oscilloscope while a brick-wall frequency response passes slightly higher frequency content.

Group delay is defined as the rate of change of the total phase shift with respect to angular frequency through a device or transmission medium. Amplifiers in analog oscilloscopes typically have some group delay at the highest frequencies. This inherent group delay minimizes the preshoot present on a step response and provides the traditional pulse response with no preshoot before the step. When zero group delay is provided at all frequencies, preshoot and overshoot is equalized.

## WaveMaster 8 Zi/Zi-A Oscilloscopes

Teledyne LeCroy provides three choices for Response Optimization Mode selection. These choices combine a frequency and group delay response to optimize the oscilloscope for particular applications.

- **Pulse Response** - A group delay compensation minimizing preshoot, this selection most resembles the response of an analog oscilloscope by controlling group delay to be slightly non-zero at the highest frequencies. In addition, a fourth-order Bessel frequency response is implemented.



- **Eye Diagram** - Flat group delay compensation resulting in equalized preshoot and overshoot. This selection improves the symmetry of serial eye diagrams. In addition, a fourth-order Bessel frequency response is implemented.



- **Flatness** - Flat group delay compensation with a brick-wall frequency response. While this provides the fastest rise time, there is also a slight penalty of more preshoot and overshoot compared to Eye Diagram mode. This selection is most often used in narrow-band RF measurements where it is desired to maintain constant magnitude response over the oscilloscope passband.



# Trigger

## Overview

Triggering is the way an oscilloscope selects an exact moment in time on a signal to then be shown on the screen. If the pattern of a signal happens to be repetitive, a continuous waveform pattern is inherently visible on the display.

But without a regular signal pattern, the oscilloscope requires controls to determine what specific point in time (when a trigger is met) to show the signal on the display. This is accomplished and affected in a variety of ways.

Some trigger settings allow for pre-trigger, post-trigger, and a delay between the time of the trigger event and the time when the display is refreshed (or swept) and the waveform is again shown on the screen.

The instrument uses many waveform capture techniques that trigger on features and conditions that you define. These triggers fall into the following major categories:

- **Simple Triggers** - activated by basic waveform features or conditions such as a positive or negative slope, and hold-off

# WaveMaster 8 Zi/Zi-A Oscilloscopes

- **SMART Triggers** - sophisticated triggers that enable you to use basic or complex conditions for triggering. Use SMART Triggers for signals with rare features, like glitches.
- **Measurement Trigger** - triggers that allow you to leverage parameter measurements as waveform trigger conditions. A measurement trigger is either the only trigger or the final trigger in a chain of trigger events including hardware triggers.
- **MultiStage Triggers** - varied forms of triggers including **Cascaded**, **QualFirst**, and **Qualified** allowing varied combinations of triggers and trigger stages.
- **Serial Triggers** - provide serial data protocol specific triggering for a wide variety of standards.

## Trigger Types

There are a set of standard Trigger Types. These Triggers are basic waveform features or conditions such as a positive or negative slope, and hold-off and are available on all oscilloscopes along with tools like **Software Assisted Trigger** and **Trigger Scan**.

In addition, there are more sophisticated triggers for setting basic or complex conditions. These include **Smart Triggers**, **Serial Trigger**, **Measurement Triggers**, and **MultiStage Triggers**.

To learn more, **Contact Teledyne LeCroy for Support**.

### *Edge*



A simple trigger, Edge trigger is activated by basic waveform features or conditions such as positive or negative slope, and holdoff.

**Note:** On **WaveMaster 8 Zi** and **Zi-A**, up to 15 GHz bandwidth is available while Edge Triggering (provided no holdoff is selected).

### *Width*

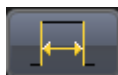

**Width** trigger allows you to define a positive- or negative-going pulse width bounded by a voltage level, above or below an occurring trigger. Or you can specify a pulse width and voltage range, within or outside an occurring trigger.

### ***Pattern (Logic)***



**Logic** trigger enables triggering on a logical combination (pattern) of five inputs: CH1, CH2, CH3, CH4, and AUX (sometimes referred to as EXT on legacy oscilloscope models). You have a choice of four Boolean operators (AND, NAND, OR, NOR), and you can stipulate the high or low voltage logic level for each input independently.

### ***Smart***

These are a specific set of sophisticated trigger types. Smart trigger types are used to set conditions on signals with rare features, like the glitches and others as follows:

#### **WINDOW**



A smart trigger occurs when a signal enters or exits a window defined by adjustable thresholds.

#### **INTERVAL**



While Glitch trigger performs over the width of a pulse, **Interval** trigger performs over the width of an interval - the signal duration (the period) separating two consecutive edges of the same polarity: positive to positive or negative to negative. Use interval trigger to capture intervals that fall short of, or exceed, a given time limit. In addition, you can define a width range to capture any interval that is itself inside or outside the specified range - an Exclusion trigger by interval.

# WaveMaster 8 Zi/Zi-A Oscilloscopes

---

## GLITCH



**Glitch** trigger is a simpler form of Width trigger. Use Glitch trigger when you want to define a fixed pulse-width time or time range only. Glitch trigger makes no provision for voltage levels or ranges.

## DROPOUT



Used primarily in single-shot applications, and usually with a pre-trigger delay, **Dropout** trigger can detect lost signals. The trigger is generated at the end of the timeout period following the last trigger source transition.

## RUNT



The **Runt** trigger occurs when a pulse crosses a first threshold line, but fails to cross a second threshold line before re-crossing the first. Other defining conditions for this trigger are the edge (triggers on the slope opposite to that selected) and runt width.

## SLEW RATE



**SlewRate** trigger activates a trigger when the rising or falling edge of a pulse crosses two threshold levels: an upper level and a lower level. The pulse edge must cross the thresholds faster or slower than a selected period of time.

## *Measurement*

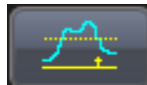

This trigger type allows you to leverage parameter measurements as waveform trigger conditions. A measurement trigger is either the only trigger or the final trigger in a chain of trigger events including hardware triggers.



## TV

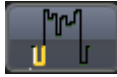

Not available on all instruments, **TV** triggers provide stable triggering on standard or custom composite video signals. Use them on PAL, SECAM, NTSC, or HDTV systems.

## Multistage

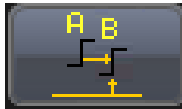

Touching this **MultiStage** trigger type shows the additional MultiStage types on the dialog. Select from **Cascaded**, **QualFirst**, and **Qualified** as follows:

### CASCADED



The Cascaded trigger allows you to define successive trigger **Stages** (referred to as Stage **A**, **B**, **C**, and **D**) as **arm**, **trigger/arm**, **trigger/arm**, **trigger** criteria, respectively.

### QUALFIRST



In single trigger mode, **QualFirst** arms the oscilloscope on the A event, and then triggers on all subsequent B events.

**Note:** This button is enabled when using the sequence sampling mode. It is commonly used in sequence mode for disk drive applications with the index pulse defined as the A qualifier signal and the servo gate signal as the B triggering events.

# WaveMaster 8 Zi/Zi-A Oscilloscopes

## QUALIFIED A-B



In single trigger mode, **Qualify A-B** arms the oscilloscope on the A event, and then triggers on the B event. If the oscilloscope is in Normal trigger mode, it automatically resets after the B event. Arm trigger events can be set for **Edge**, **Pattern**, **State**, and **PatState**. State is briefly explained as follows:

### State

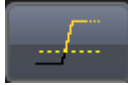

The **State** trigger is a level-qualified trigger which requires that the qualifying signal remain above or below a specified voltage level for a trigger to occur. For State trigger, you specify the time or number of events after the signal has gone above or below the voltage level when you want the trigger to occur.

## Serial Trigger



Protocol-enabled serial trigger capabilities are available as options on several oscilloscope models.

### Clock and Data Recovery (CDR)

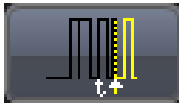

**SERIES-SPECIFIC FEATURE:** 80-bit Serial Trigger (without decode capability) is standard on SDA model oscilloscopes and optional on DDA model oscilloscopes.

## Trigger Settings

Horizontal and Vertical adjustments are typically made for all trigger types using either the **Delay** or **Level** knobs on the front panel of the instrument or their respective controls on the **Timebase** setup dialog.

- **Horizontal:** Turn the **DELAY** knob in the HORIZONTAL control group to adjust the trigger's horizontal position. Or, touch inside the **Delay** control and provide a value on the **Timebase** dialog using your preferred input control method. Additional information on using the touch screen controls can be found in the **Dialog Area** (on page 33).

The trigger location is shown by a marker under the grid.



Post-trigger delay is indicated by a left-pointing arrow at the lower-left of the grid.



The time value is given in the title line of the **Timebase** label at the lower-right of the grid.

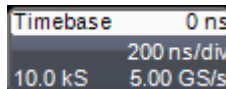

- **Vertical:** Turn the **LEVEL** knob in the TRIGGER control group to adjust the trigger's vertical threshold.

Turn this knob to adjust the level of the trigger source or the highlighted trace. Level defines the source voltage at which the trigger will generate an event: a change in the input signal that satisfies the trigger conditions.

Alternatively, in the Trigger dialog, you can touch inside the **Level** control and provide a value using your preferred input control method. Additional information on using the touch screen controls can be found in the **Dialog Area** (on page 33). Quickly set a level of zero volts by touching the **Zero Level** button.

An arrow on the right side of the grid shows the threshold position. This arrow is only visible if the trigger source is displayed.

## Trigger Setup

Based on your **Trigger Type** selection, sections of the main Trigger dialog and additional dialogs altogether vary.

Most trigger types have **Type**, **Setup**, and **Level** selections. The following sections explain some of the standard setup configurations for different trigger types.



1. Make your **Type** selection by touching the button corresponding to the desired trigger.
2. Touch inside the trigger **Source** control for your first **Setup** configuration and select a source on which to trigger.
3. If available, touch inside the **Coupling** control and select a coupling mode.

**Coupling** refers to the type of signal coupling at the input of the trigger circuit. Choices of trigger coupling vary by oscilloscope model.

With DC coupling, all of the signal's frequency components are coupled to the trigger circuit for high-frequency bursts.

4. Touch inside the trigger **Slope** control and choose the direction of the trigger voltage transition used for generating a particular trigger event.

The selection is then shown to the right of the dialog as follows for a Positive Slope selection on an Edge Trigger.

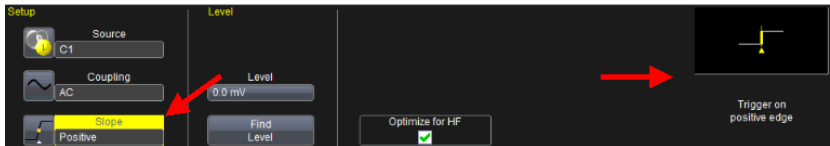

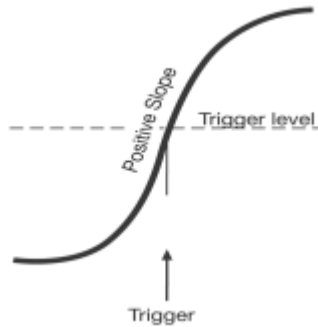

**Edge trigger works on the selected edge at the chosen level. The slope (positive or negative) is specified on the Trigger label permanently shown to the lower-right of the grid.**

5. **Level** defines the source voltage at which the trigger circuit generates an event (a change in the input signal that satisfies the trigger conditions). The selected trigger level is associated with the chosen trigger source.

**Note:** The trigger level is specified in volts and normally remains unchanged when the vertical gain or offset is modified. The Amplitude and Range of the trigger level have limits as detailed in the datasheet specifications regularly maintained on [teledynelecroy.com](http://teledynelecroy.com).

Touch inside the **Level** data entry control and provide a voltage level (in millivolts).

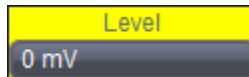

## PLEASE NOTE THE FOLLOWING:

- Once specified, **Trigger Level** and **Coupling** are the only parameters remaining unchanged as you switch from trigger mode to trigger mode for each trigger source.
- Some additional controls and dialogs for triggers that differ are provided in the following topics as examples.

# WaveMaster 8 Zi/Zi-A Oscilloscopes

## Optimize for HF

The Optimize for HF checkbox can be used on an **Edge** trigger to reject high or low frequencies.

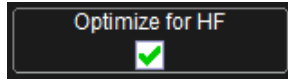

The checkbox is marked by default; meaning, the instrument is optimized for high-frequency waveforms.

**Note:** If you are measuring a waveform that is 10 MHz or slower, be sure to unmark the checkbox to avoid triggering on an incorrect slope.

## Width Condition is

**Width** triggers (and other triggers equipped with conditional logic) have conditional logic settings as follows.



Your **Width Condition** can be specified as **Less Than**, **Greater Than**, **In Range** and **Out Of Range**.

**In Range** and **Out Of Range** conditions can be further set with **Upper** and **Lower Values** (for **Limits**), or **Nominal width** and **Delta** (for **Delta**).

**Note:** Width Condition settings are summarized on the far right of the dialog.

## Holdoff by Time or Events

Holdoff is an additional condition of Edge and Pattern triggers. It can be expressed either as a period of **time** or an **event** count. Holdoff disables the trigger circuit for a given period of time or number of events after the last trigger occurred. Events are the number of occasions on which the trigger condition is met. The trigger resumes when the holdoff has elapsed and its other conditions are met.

Set holdoff by touching the **Time** or **Events** buttons on the **Holdoff** dialog.

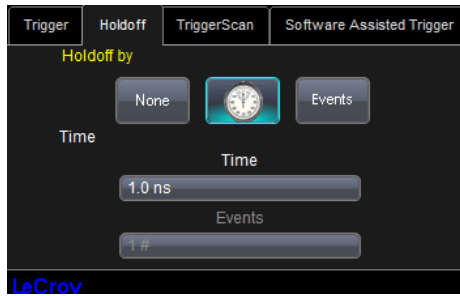

Now, click the corresponding control and provide a value.

Use holdoff to obtain a stable trigger for repetitive, composite waveforms. For example, if the number or duration of sub-signals is known you can disable them by choosing an appropriate holdoff value. Qualified triggers operate using conditions similar to holdoff.

## HOLD OFF BY TIME

Sometimes you can achieve a stable display of complex, repetitive waveforms by placing a condition on the time between each successive trigger event. This time would otherwise be limited only by the input signal, the coupling, and the instrument's bandwidth. Select a positive or negative slope, and a minimum time between triggers. The trigger is generated when the condition is met after the selected holdoff time, counted from the last trigger. The delay is initialized and started on each trigger.

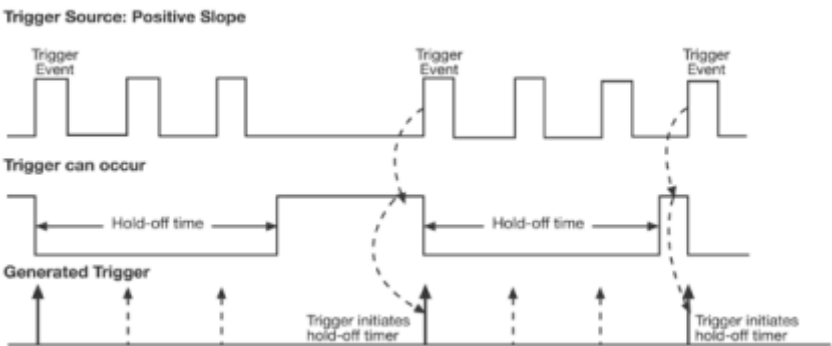

**Edge Trigger with Holdoff by Time. The bold edges on the trigger source indicate that a positive slope has been selected. The broken upward-pointing arrows indicate potential triggers, which would occur if other conditions are met. The bold arrows indicate where the triggers actually occur when the holdoff time has been exceeded.**

# WaveMaster 8 Zi/Zi-A Oscilloscopes

## HOLD OFF BY EVENTS

Select a positive or negative slope and a number of events. An event is the number of times the trigger condition is met after the last trigger. A trigger is generated when the condition is met after this number, counted from the last trigger. The count is restarted on each trigger. For example, if the event number is two, the trigger occurs on the third event.

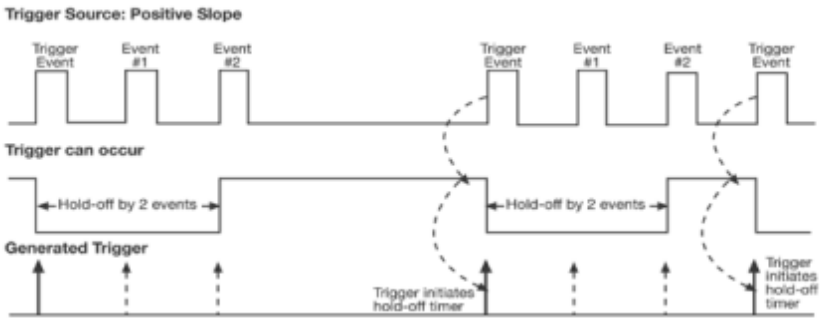

*Edge Trigger with Holdoff by Events (in this example, two events). The bold edges on the trigger source indicate that a positive slope has been selected. The broken, upward-pointing arrows indicate potential triggers, while the bold ones show where triggers actually occur after the holdoff expires.*

## Auxiliary Input Trigger

Some instrument models provide auxiliary input trigger capability. It's done as a pattern trigger, on the **Ext** dialog.

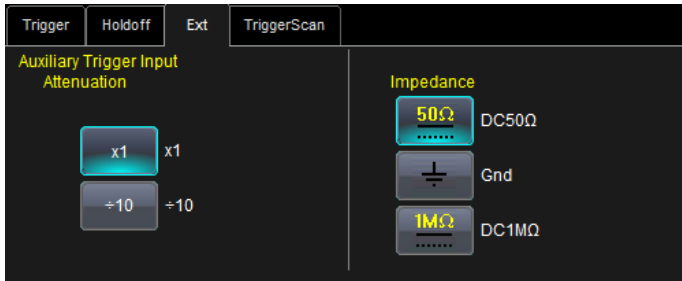

Select **X1**, or **÷10**. You can also select from **DC50Ω**, **Gnd**, and **DC1MΩ** Impedance values.



# TriggerScan

TriggerScan is a debugging tool (available for any trigger type) that helps you quickly find rare waveform glitches and anomalies. With TriggerScan, you can build a list of trigger setups to look for rare events and automatically sequence through each one. TriggerScan can use any type of trigger setup available including edge, width, and qualify as well as Smart Triggers (such as, glitch and runt triggers). TriggerScan automates two key processes in triggering rare events:

1. Trains the system by looking at normal acquired waveforms. During the training, the oscilloscope analyzes the waveforms to determine what waveforms normally look like. Using this information, it generates a list of smart trigger setups to trigger on abnormal situations.
2. Loads the smart trigger setups from the Trainer and cycles through these. As triggers occur, they are overlaid on the screen. All acquisition settings are preserved and you can use all the functions of the oscilloscope to find the root cause of these anomalies including, WaveScan, Histograms, and advanced analysis.



## Training TriggerScan

The TriggerScan Trainer inspects a currently acquired waveform and automatically builds a list of common trigger setups used to find rare events.

### PLEASE NOTE THE FOLLOWING:

- You must acquire and display at least 3 cycles of a signal before running the Trainer.
  - You should run the Trainer if you want to change the trigger types or if you change the channel or signal.
1. Touch **Trigger** → **Trigger Setup...** from the menu bar.
  2. On the **Trigger** dialog, click the **TriggerScan** tab.
  3. Touch the **Trainer** button and select a channel as the source for the training on the **Trigger Scan Trainer** pop-up. Also choose the types of triggers the Trainer should use to train the system and then touch the **Start Training** button. The training begins. When it is complete, a list of smart trigger setups is displayed in the Trigger List.

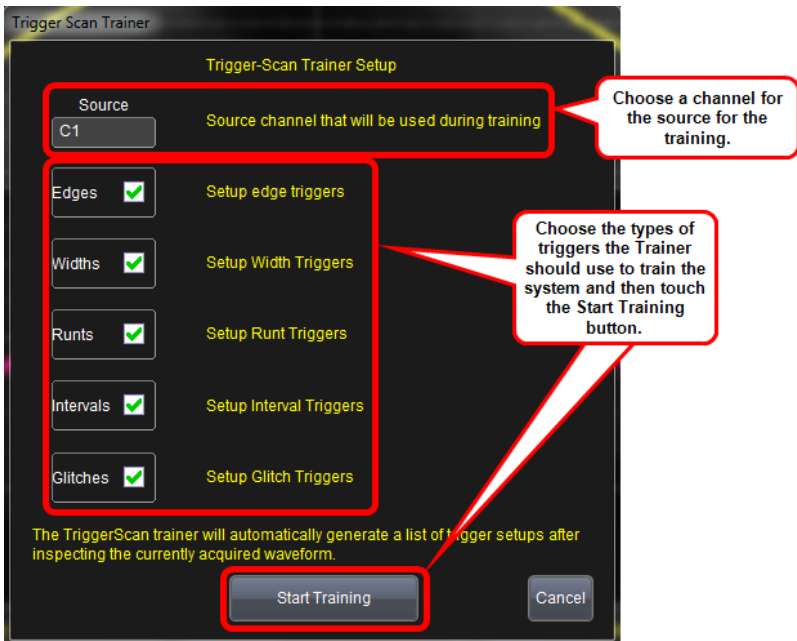

## Starting TriggerScan

After you have run the Trainer, the Trigger List displays a list of smart trigger setups. You can add or remove trigger setups. You can also update the selected smart trigger setup. Once you have made any changes to the Trigger List, you are ready to start scanning.

1. Touch **Trigger** → **Trigger Setup...** from the menu bar.
2. On the **Trigger** dialog, click the **TriggerScan** tab and its corresponding dialog is shown.



3. If you want to add a new trigger setup, touch the **Trigger** tab and set the new trigger as desired on the **Trigger** dialog. Then, back on the **TriggerScan** dialog, touch the **Add New** button to append the new trigger to the **Trigger List**.
4. If you want to replace the selected trigger setup with the current trigger setup, highlight the setup in the Trigger List and touch the **Update Selected** button.
5. If you want to show a specific trigger setup on the Trigger List, highlight its corresponding row on the list, and then touch the **Load Selected** button.

**Note:** If you want to delete all trigger setups in the Trigger List, touch the **Delete All** button.

6. If you want to delete a trigger setup, highlight the setup in the Trigger List and touch the **Delete Selected** button.
7. All trigger setups can be deleted regardless of selections on the Trigger List with one step by touching the **Delete All** button.
5. Once you have made any changes to the Trigger List, touch the **Trainer** button and then restart the scan by touching the **Start Training** button on the Trigger Scan Trainer pop-up. The oscilloscope automatically sequences through all the trigger setups.

## WaveMaster 8 Zi/Zi-A Oscilloscopes

---

### PLEASE NOTE THE FOLLOWING:

- You can tune the dwell time that the oscilloscope waits before loading the next trigger setup using the **Dwell Time** data entry control.
- If you have Persistence display mode enabled, all trigger events are recorded on the display. Refer to the **Persistence Setup** (on page 82) topic for instructions on enabling Persistence display mode.
- If you want TriggerScan to stop when the next oscilloscope trigger, check the **Stop On Trigger** checkbox. You can use this to isolate specific trigger setups.

### *Saving TriggerScan Setups*

You should save TriggerScan setups once you have made any modifications to the Trigger List. The current Trigger List is not be preserved after exiting the application unless you save it.

1. On the **TriggerScan** dialog, touch inside the **Setup File Name** data entry control and providing a file name using your preferred input control method. Additional information on using the touch screen controls can be found in the **Dialog Area** (on page 33).

**OR**

Touch the **Browse** button and select a location and file name.

2. Touch the **Save Setup...** button.

**Note:** You can load previously saved TriggerScan setups by touching the **Browse** button, locating the file, and then touching **Load Setup....**

# Viewing Waveforms

## Display

Oscilloscope display grids present the trace information in a voltage vs. time format. The oscilloscope analog-to-digital converter (ADC) information is displayed vertically on the grid with the ADC bits divided proportionally according to their amplitude on the grid. Channel traces are typically 8-bits of vertical data, whereas Math traces are 16-bits of vertical data. Teledyne LeCroy grids consist of eight vertical divisions.

When displaying channel traces on the grid, use of less than full-grid amplitude results in some reduced vertical resolution and accuracy. For instance, if a channel trace is displayed as two divisions high on a grid, the number of ADC bits utilized is...

$$2/8 * 2^8 \text{ or } 64 \text{ bits}$$

This is quite less than the full 8-bit resolution. Such a reduction in vertical resolution may be acceptable if the primary measurement consideration is for rough timing measurements; however, if vertical accuracy or extreme timing accuracy is a requirement, it is better to increase the amplitude of the signal to utilize close to maximum grid height. In order to accomplish this while still providing the ability to view many signals at one time on the oscilloscope display Teledyne LeCroy provides **multi-grid** capability. This creates multiple oscilloscope grids, each with 8-bit vertical resolution, and allows many full-resolution grids (but vertically smaller in grid height) for concurrent display without affecting the vertical resolution.

Different grid displays are available based on instrument and installed software packages. For example, some displays show side-by-side, instead of vertically stacked grids. The additional grid displays offer more convenient views of multiple waveforms. Refer to your instrument datasheet at [teledynelecroy.com](http://teledynelecroy.com) for detailed information as to which grid displays are provided with your oscilloscope.

## Display Setup

Access and adjust the different display configurations on our oscilloscope using the following steps:

**Note:** Not all grid styles are available on all instruments. Grid styles vary based on both oscilloscope model and whether or not you have the SDAll software option loaded on your oscilloscope.

1. Touch **Display** → **Display Setup...** on the menu bar.
2. Touch one of the **Display combination buttons**.

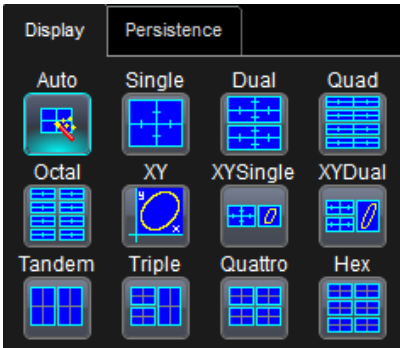

### PLEASE NOTE THE FOLLOWING:

- Small images label each **Display combination** button and indicate its corresponding grid configuration.
- **Autogrid** automatically adds or deletes grids as you select more or fewer waveforms to display.
- If more than a certain amount of display setups are available for your oscilloscope, a **Grid** control is shown and presents the **Select Grid** pop-up when touched.

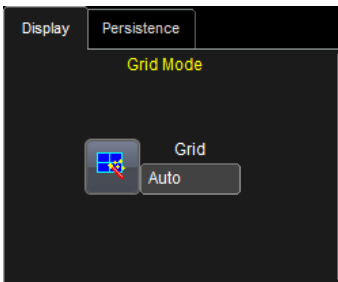

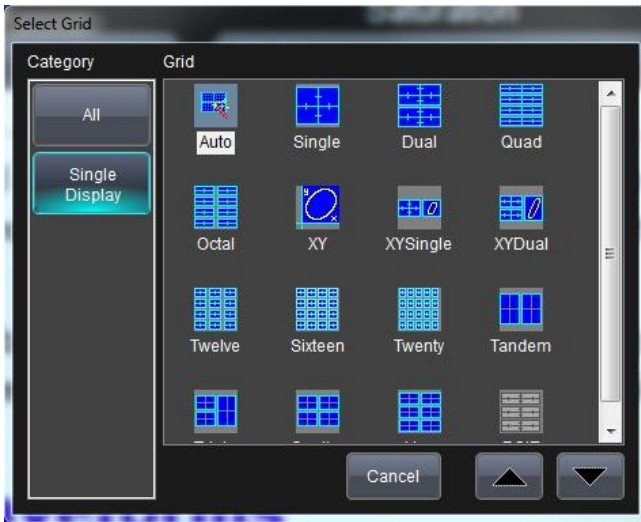

3. Touch inside the **Grid Intensity** data entry control (as follows).

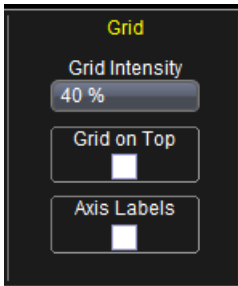

Provide a value from 0 to 100.

4. Touch the **Grid on top** checkbox if you want to superimpose the grid over the waveform.

**Note:** Depending on the grid intensity, some of your waveforms may be hidden from view when the grid is placed on top. To undo, simply uncheck **Grid on top**.

3. Touch the **Axis labels** checkbox to permanently display the values of the top and bottom grid lines (calculated from volts/div) and the extreme left and right grid lines (calculated from the timebase).
4. Choose a line style for your trace: solid Line or Points as follows:

## WaveMaster 8 Zi/Zi-A Oscilloscopes

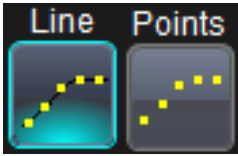

5. Touch inside the trace **Intensity** data entry control if you want to change the value.

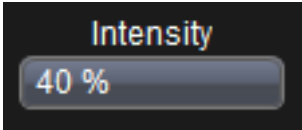

Enter a value from 0 to 100.

**Note:** Access the Monitor tab for external monitor display settings. Refer to the **External Display** topic for more details.

### SEQUENCE MODE DISPLAY

Set up a Sequence Mode display by first selecting a **Sequence** trigger mode in the **Timebase** → **Horizontal Setup** dialog. You must also have entered a **Num Segments** value. For more information on setting up Sequence Mode, see the **Sequence Sampling Mode** (on page 46) topic.

1. Touch **Display** → **Display Setup...** on the menu bar.
2. Touch inside the **Display Mode** control and select a display mode from the pop-up menu.
3. Touch inside the **Num seg displayed** control and enter a value, using the pop-up keypad.
4. Touch inside the **Starting at** control and enter a value.

### *Moving Traces from Grid to Grid*

You can move traces from grid to grid with the touch of a button.

#### Moving a Channel or Math Trace

1. Touch the trace descriptor label for the waveform you want to move.

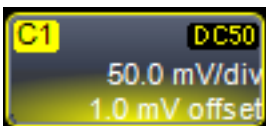

2. Touch the **Next Grid** button.



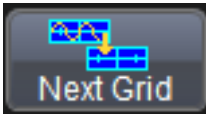

**Note:** If you have more than one waveform displayed on only one grid, a second grid automatically opens when you select **Next Grid**.

## Displays Containing Masks

Since masks are pixel-based display renderings, you can think of them as part of the Display feature set on your instrument. Masks and mask testing are applied to waveforms as part of **Pass/Fail** functionality accessed from **Analysis** → **Pass/Fail** from the menu bar.

**Note:** For more detailed information about Masks and other Pass/Fail functionality, such as removing a mask from your display, refer to **Mask Testing** (on page 117).

## Dual Display Grid Selection

Make a dual grid display selection for showing on an external display (once properly connected to the I/O panel) by selecting **Display** → **Display Setup**.... Numbered labels on this image correspond with the following steps.

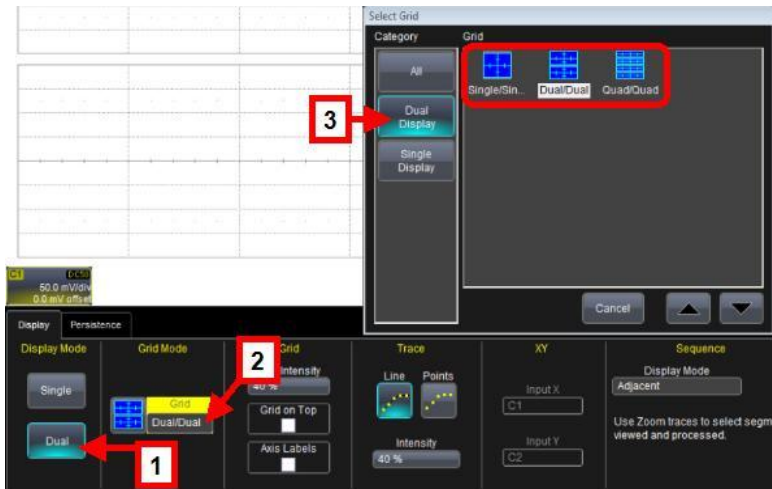

**Note:** First-time setup may show a different Display tab. Fix this by touching **File** → **Exit** on the menu bar and re-launching the oscilloscope software using the **Start DSO** shortcut on the desktop.

## WaveMaster 8 Zi/Zi-A Oscilloscopes

---

1. Touch the **Dual** button on the Display Mode section of the Display dialog.
2. Touch inside the **Grid** control on the Grid Mode section of the dialog. The **Select Grid** pop-up is shown.
3. Touch the **Dual Display** category and choose from **Single/Single**, **Dual/Dual**, and **Quad/Quad** options.

Your grid selection is now shown on both displays.

## Persistence

The Persistence feature helps you display your waveform and reveal its idiosyncrasies or anomalies for a repetitive signal. Use Persistence to accumulate on-screen points from many acquisitions to see your signal change over time. The instrument persistence modes show the most frequent signal path in three-dimensional intensities of the same color, or graded in a spectrum of colors.

You can show persistence for up to eight inputs for any channel, math function, or memory location (M1 to M4).

### *Persistence Setup*

Touch **Display** → **Persistence Setup...** on the menu bar.

Now, touch the **Persistence On** checkbox and refer to the following scenarios based on your needs.

#### **Persistence Setup for All Input Channels at Once**

1. Touch the **All Locked** button.

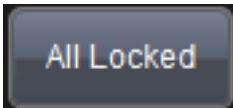

2. Touch one of the **Mode** buttons.



3. Touch the **Show last trace** checkbox if you want the last trace displayed.

4. Touch inside the **Saturation** data entry control and provide a whole number integer.

For more information on saturation, see the **Saturation Level** topic.

5. Touch inside the **Persistence time** data entry control and make a selection from the pop-up menu.

### ***Individual Persistence Setup for Each Channel***

1. Touch the **Per Trace** button.
2. Touch one of the **persistence mode** buttons next to an input channel.



To turn off persistence for an individual channel, touch the left-most persistence mode button next to the channel.

**OR**

For each input channel, touch its tab to set up persistence for that channel.

3. Touch one of the **mode** buttons.



4. Touch the **Show last trace** checkbox if you want the last trace displayed.
5. Touch inside the **Saturation** data entry control and enter a whole number integer,.
6. Touch inside the **Persistence time** data entry control and make a selection from the pop-up menu.
7. If you want to return all input channel setups to their default settings, touch the **Reset All** button.

## WaveStream Display Mode

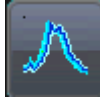

This fast viewing mode provides brightness-graded intensity with a decay time similar to the action of phosphor on an analog screen.

WaveStream mode operates at up to 80 GS/s with an update rate of up to several thousand waveforms/second for better capture of higher frequency abnormal events.

## Adjusting Trace Intensity

The **INTENSITY** knob adjusts the brightness of your trace.



The intensity value is shown in the bottom-right corner of the screen.

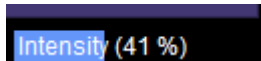

### PLEASE NOTE THE FOLLOWING:

Pushing the **Intensity** knob changes the Persistence status in the following ways.

- **OFF** - When the button hasn't been pushed, it may be turned to control the trace **Intensity** value.
- **Analog Persistence** - When the button is pushed once, the waveform resembles a trace on a phosphor oscilloscope. Turning the knob affects persistence with a blended form of intensity and saturation. As the knob is turned clockwise, the **Intensity** value increases while the **Saturation** value decreases. The opposite occurs when the button is turned counter clockwise.



- **Color Persistence** - The button behaves the same way as Analog. However, the grid display shows a color waveform where red

indicates most frequent occurrences while blue denotes the less frequent.

Instead of using the knob, you can provide values for **Intensity** (same control on Display and Persistence dialogs) or **Saturation** controls.

# Zooming Waveforms

## Overview

You can magnify a selected region of a waveform using the Zoom function. On Zi model oscilloscopes, you can display up to four Zoom (Z1 - Z4) and eight Math Zoom traces (F1 - F8). You can zoom:

- A single channel
- A math or memory trace
- Multiple waveforms at once
- Segments in a sequence

At any time, you can zoom a portion of a channel waveform or Memory/Math function trace by touching and dragging a rectangle around any part of the input waveform, see *To Zoom by Touch-and-Drag* (on page 88). The zoom trace will size itself to fit the full width of the grid. The degree of magnification, therefore, will depend on the size of the rectangle that you draw.



You can also use the front panel **QUICKZOOM** button to create multiple zooms, one for each displayed input channel. For more information, see *To Zoom Multiple Waveforms Quickly* (on page 88).

## Previewing Zoomed Waveforms

When you zoom a waveform, a preview of the zoomed area is shown on the **Preview** section of the **Zx** dialog.

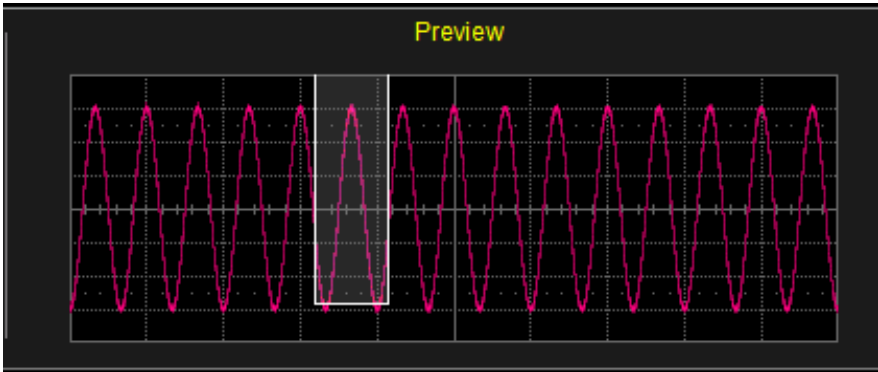

## Zooming a Single Channel

1. On the menu bar, touch **Vertical** → **Channel X Setup...**

**OR**

Touch the channel trace descriptor label for a displayed channel.



2. Touch the **Zoom** at the bottom of the **Cx Vertical Adjust** dialog. A zoom trace (one of Z1 to Z4) is created for the selected channel.
3. Vary the degree of zoom by touching the newly created **Zx** trace label. The setup dialog for the zoom (Z1 to Z4) opens. It shows the current horizontal and vertical zoom factors.
4. If you want to increase or decrease your horizontal or vertical zoom in small increments, touch the **Var.** checkbox to enable variable zooming. Now with each touch of the zoom control buttons, the degree of magnification changes by a small increment.



### **OR**

If you want to zoom in or out in large standard increments with each touch of the zoom control buttons, leave the **Var.** checkbox unchecked.

### **OR**

If you want to set exact horizontal or vertical zoom factors, touch inside the Horizontal **Scale/div** data entry control and provide a time-per-div value using your preferred input control method. Additional information on using the touch screen controls can be found in the **Dialog Area** (on page 33). Then touch inside the Vertical **Scale/div** control and enter a voltage value.

### **PLEASE NOTE THE FOLLOWING:**

To reset the zoom to x1 magnification, touch **Reset Zoom** on the Zoom dialog. You can also use the Zoom and Math front panel knobs to adjust the horizontal and vertical zoom.

- **Horizontal Position** - Press to reset the horizontal zoom position to zero. Turn to change the horizontal position of the selected math or zoom trace.
- **Horizontal Ratio** - Press to toggle between fixed and variable horizontal zoom ratio adjustment. Turn to change the horizontal zoom ratio of the selected math trace.
- **Quick Zoom** - Press to automatically display magnified views of up to four signal inputs on multiple grids. With four input signals, the signals are displayed along with four zoom traces, each on its own grid. Pressing this button also turns off all other traces.
- **Vertical Position** - Press to reset the vertical zoom position to zero. Turn to change the vertical position of the selected math or zoom trace.
- **Vertical Ratio** - Press to toggle between fixed and variable vertical zoom ratio adjustment. Turn to change the vertical zoom ratio of the selected math trace.

### Touch-and-Drag Zooming

1. Touch and drag a rectangle around any part of an input channel waveform, math trace, or memory trace. The **Zoom** (Z1 to Z4) dialog opens.

**Note:** If you have enclosed a combination of channel and math or memory traces in the rectangle, a pop-up **Rectangle Zoom Wizard** is shown. Touch a **Zoom** button (Z1 to Z4).

2. Turn off the zoom traces by touching the **Undo** button at the top-right corner of the screen.



*OR*

Uncheck the **Trace On** checkbox in the dialog for each zoom trace.

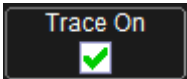

### Quickly Zooming Waveforms and Multiple Waveforms

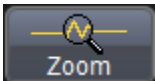

Quickly create a Zoom trace by either pressing the front panel **Zoom** button or touching the Zoom button on the respective channel dialog.

### Turning Off Zoom

Turn off a Zoom by either pressing the front panel **Zoom** button again.

*OR*

On the corresponding Zoom dialog, touch the **Trace On** checkbox to remove the check mark and disable the zoom trace.

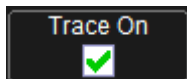



# Measuring with Cursors

## Overview

Cursors are important tools that aid you in measuring signal values. Cursors are markers - lines, cross-hairs, or arrows - that you can move around the grid or the waveform itself. Use cursors to make fast, accurate measurements and eliminate guesswork. There are two basic types:

- **Horiz(ontal)** (generally Time or Frequency) cursors are markers that you move horizontally along the waveform. Place them at a desired location along the time axis to read the signal's amplitude at the selected time.
- **Vert(ical)** (Voltage) cursors are lines that you move vertically on the grid to measure the amplitude of a signal.

## Cursor Types

Each cursor locates a point on the waveform. The cursor values can be read in the descriptor label for the trace. Use the **Position** data entry controls at the right side of the dialog to place the cursors precisely. The **Readout** icons depict what is being measured for each measurement mode.

**Cursor Types** include **Absolute**, **Delta**, **Abs+Delta**, and **Slope**. The following topic explains them and other cursor information in a bit more detail.

## Cursors Setup

### *Quickly Displaying Cursors*

Cursors can always be quickly turned on and off from the **touch screen** or the **front panel control**, respectively as follows:

- Touch **Cursors** on the menu bar and make cursor control selections as desired. **Off**, **Horizontal Abs**, **Horizontal Rel**, **Vertical Abs**, and **Vertical Rel** options are available on the menu.
- Press the **CURSOR TYPE** button on the front panel repeatedly for all the available cursor types on your instrument. Turn the **CURSORS** knobs to adjust the position of the cursor.

# WaveMaster 8 Zi/Zi-A Oscilloscopes

## PLEASE NOTE THE FOLLOWING:

- The bottom cursor knob adjusts relative cursors. It does not work with absolute cursor types.
- Previously setup cursor positions are preserved for subsequent displays. Changing cursor positions or measurement modes are always available using **touch screen** or **front panel control** methods as previously mentioned.

## The Cursors Dialog

Whether using **touch screen** or **front panel control** methods (as previously mentioned) to access cursors, the **Cursors** dialog is then shown.

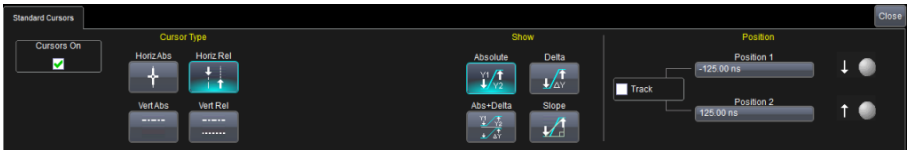

## CURSORS ON

Mark or unmark the **Cursors On** checkbox to turn cursors on and off as desired.

## CURSOR TYPE CONTROLS

Select your **Cursor Type** from **Horizontal Abs**, **Horizontal Rel**, **Vertical Abs**, and **Vertical Rel** options shown. Subsequent controls on the dialog are shown, hidden, enabled, or disabled based on the **Cursor Type** selection.

- **Horizontal Abs** - Provides a single, dashed, vertical line and cross-hair marking for the specific cursor location. None of the **Show** controls are provided; however, the **Position 1** control is enabled on the right of the dialog.
- **Horizontal Rel** - Provides two, dashed, vertical lines and cross-hair markings for the specific cursor locations. Since there are two cursors involved, controls for **Show** along with **Track**, and **Position 1** and **2** are available on the dialog.
- **Vertical Abs** - Provides a single, dashed, horizontal line and cross-hair marking for the specific cursor location. None of the **Show** controls are provided; however, the **Position 1** control is enabled on the right of the dialog.

- **Vertical Abs** - Provides a single, dashed, horizontal line and cross-hair marking for the specific cursor location. None of the **Show** controls are provided; however, the Position 1 control is enabled on the right of the dialog.

### SHOW (FOR RELATIVE CURSOR TYPES)

**Show** controls (**Absolute**, **Delta**, **Abs+Delta**, and **Slope**) become available on the dialog when Relative Cursors (**Horizontal** or **Vertical Rel** cursor types) are chosen.

For **Horizontal** and **Vertical Rel** cursor types, you can also specify **Position 1** and **2** time values for your cursor locations. You also have the option to mark the **Track** checkbox which allows you to move your Position 1 cursor (using the touch-screen display or front panel control) and have both cursors then move together and maintaining their relative distance from their originally specified positions.

The **Show** controls essentially display cursor value results on the signal's corresponding **Trace Descriptor** label as follows:

- **Absolute** - The Trace Descriptor label shows **specific voltages** for the position location values provided.
- **Delta** - The Trace Descriptor label shows the **difference between the specific voltages** for the position location values provided.
- **Abs+Delta** - The Trace Descriptor label shows both the **specific voltages** and the **difference between the specific voltages** for the position location values provided.
- **Slope** - The Trace Descriptor label calculates the **slope** based on the position location values provided.

### *Cursors on Math Functions*

You can place cursors on a math function whose X-axis has a dimension other than time (FFT, for example). With a Math trace setup for either an FFT or a Histogram, if you then access the **Standard Cursors** dialog (**Measure → Cursors Setup...**), an **X-Axis** control is made available where you can choose from available units. The following shows cursors on a histogram and therefore an appropriate selection for **V (histo)** is available.

## Measurement Parameters

### Overview

Parameters are measurement tools that determine a wide range of waveform properties. Use them to automatically calculate many attributes of your waveform, like rise-time, rms voltage, and peak-to-peak voltage, for example.

There are parameter modes for the amplitude and time domains, custom parameter groups, and parameters for pass and fail testing. You can make common measurements on one or more waveforms.

### Turning On Parameters

1. Touch **Measure** → **Measure Setup...** on the menu bar.
2. Touch the **On** checkbox for each parameter you want to enable.
3. Touch the **Show Table** checkbox to display the parameters below the grid.

### Quick Access to Parameter Setup Dialogs

You can quickly gain access to a parameter setup dialog by touching the parameter list box below the grid.



For example, touch within **P1** below the grid (previous) to display the P1 setup dialog.

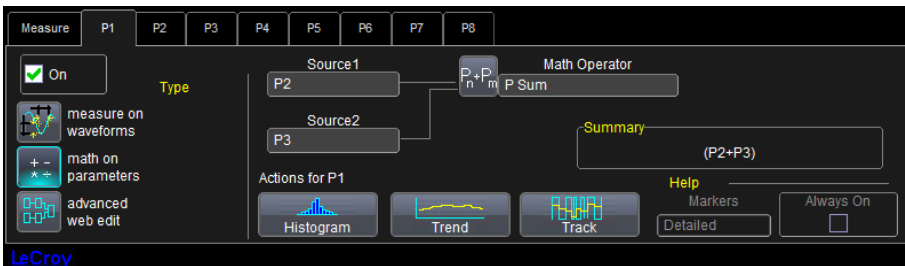

Touch any of the measurements on the table display (under the grid display area) to show its corresponding **Measure** dialog.



## Parameter Setup

1. Touch the parameter tab (**Px**) of an unused location or one that you want to change.
2. Under **Type**, select a measurement type:

### Measure On Waveforms



Applies measurements directly on the waveform as indicated on the **Source1** control.

### Math On Parameters



Performs math (addition, subtraction, multiplication, division) on parameters indicated on the **Source1** and **Source2** controls.

### Advanced Web Edit



Selecting this type uses Teledyne LeCroy's Processing Web for measurement setup. This feature, available with the XWEB option, allows you to chain practically unlimited math functions together for operation on your waveform measurements.

3. Touch inside the **Source1** field and select a channel, math trace, memory trace, or other waveform to be measured.
4. If you selected **Measure On Waveforms**, touch inside the **Measure** field and select a parameter from the pop-up menu.

## WaveMaster 8 Zi/Zi-A Oscilloscopes

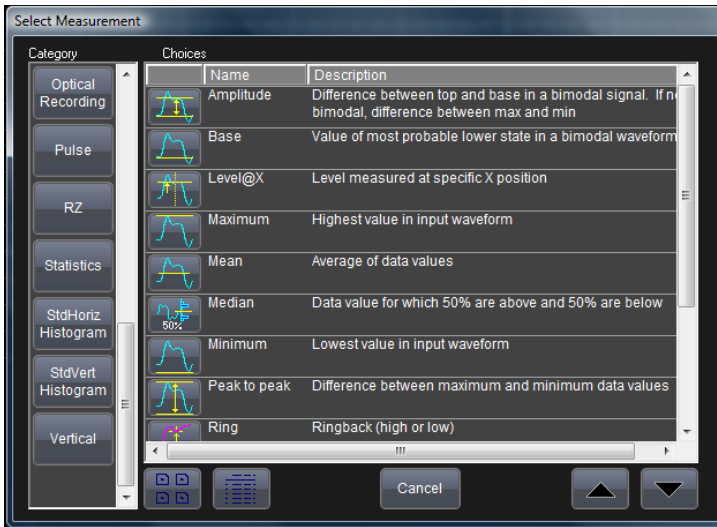

### OR

If you selected **Math On Parameters**, touch inside the **Math Operator** data entry field and select a math function from the pop-up menu.

5. In the mini-dialog to the right of the main setup dialog, touch the **Gate** tab to narrow the span of measurement - as covered in the **Measure Gate** topic (available in the online help files).
6. Touch the **Accept** tab to define parameter values to be used in the measurement - as covered in the **Qualified Parameters** topic (available in the online help files).

## Measure Modes

The selections for Measure Mode allow you to quickly apply parameters for **standard vertical** and **standard horizontal** setups, and custom setups.

### *Standard Vertical Parameters*

These are the default Standard Vertical Parameters:

| Vertical |      |      |      |      |      |     |      |
|----------|------|------|------|------|------|-----|------|
| mean     | sdev | max. | min. | ampl | pkpk | top | base |

### *Standard Horizontal Parameters*

These are the default Standard Horizontal Parameters:

| Horizontal |        |       |      |      |       |      |            |
|------------|--------|-------|------|------|-------|------|------------|
| freq       | period | width | rise | fall | delay | duty | num points |

### *Selecting Measure Modes*

1. Touch **Measure** → **Measure Setup...** on the menu bar.
2. Under **Measure Mode**, select the **Std Vertical** or **Std Horizontal** buttons.

**Note:** You can customize parameters by touching **My Measure**. Learn more in the *Customize a Parameter* topic (available in the online help files).

3. Touch inside the **Source** data entry control and choose a source for which the measurements should apply.

## Help Markers

Help Markers clarify parameter measurements by displaying movable cursors and a visual representation of what is being measured. For the **at level** parameters, Help Markers make it easier to see where your waveform intersects the chosen level. This feature also displays the hysteresis band that you have set about that level.

You also have the option, by means of an **Always On** checkbox, to leave the Help Markers displayed after you have closed the Help Markers setup dialog.

# WaveMaster 8 Zi/Zi-A Oscilloscopes

You have a choice of **Simple** or **Detailed** views of the markers:

- The **Simple** selection produces cursors and Measure Gate gate posts. The gate posts are independently placeable for each parameter.
- The **Detailed** selection produces cursors, Measure Gate gate posts, a label identifying the parameter being measured, and a level indicator and hysteresis band for **at level** parameters (not part of Standard Horizontal or Standard Vertical parameters).

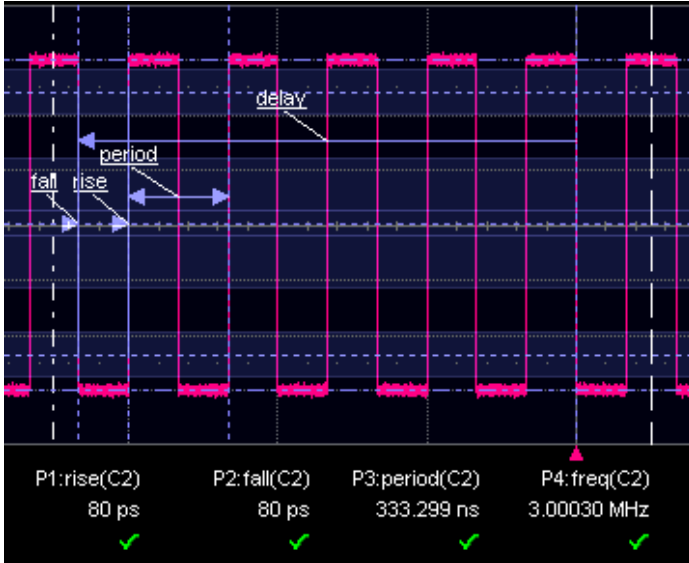

*Standard Horizontal Parameter Help Markers*

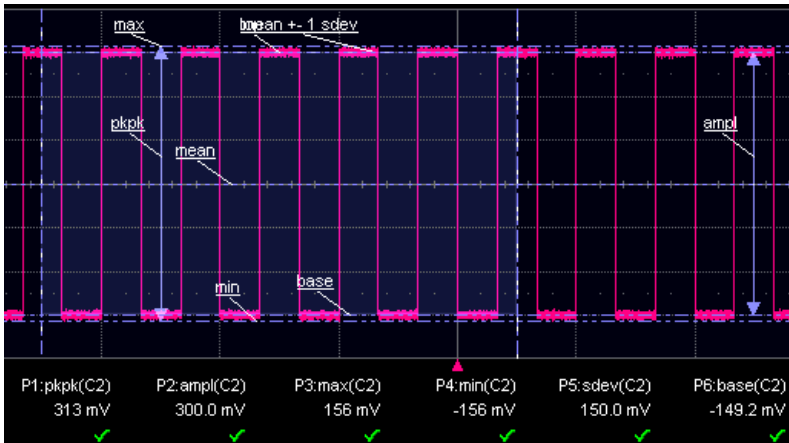

*Standard Vertical Parameter Help Markers*



## Help Markers Setup

1. Touch **Measure** → **Measure Setup...** on the menu bar.
2. Select a Measure Mode: **Std Vertical**, **Std Horizontal**, or **My Measure**.
3. Touch the **Show All** button (as follows) to display Help Markers for every parameter being measured on the displayed waveform (C2 in the previous examples).

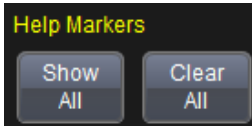

4. Touch a **Px** for any listed parameter; it doesn't matter which.

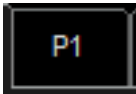

Now, on its corresponding dialog, touch inside the **Help Markers** control and select **Simple** or **Detailed**. The **Simple** selection produces cursors and Measure Gate gate posts. The gate posts are independently placeable for each parameter. The **Detailed** selection produces cursors, Measure Gate gate posts, a label identifying the parameter being measured, and a level indicator and hysteresis band for "at level" parameters.

**Note:** The choice of **Simple** or **Detailed** is applied to all parameters at the same time. That is, if you choose Simple markers for one parameter, all parameters are then displayed in this mode.

5. Touch the **Always On** checkbox if you want to continuously display Help Markers for this parameter.

## Turning Off Help Markers

1. Touch the **Clear All** button to turn off Help Markers for all parameters.
2. Turn off Help Markers for individual parameters by touching the **Px** tab for the parameter in question. Then uncheck the **AlwaysOn** checkbox. When you close this dialog, the Help Markers for this parameter are no longer shown.

# Measurement Parameter Analysis

## Overview

Teledyne LeCroy provides a variety of unique capabilities for advanced measurement parameter analysis. Most Teledyne LeCroy oscilloscopes calculate measurements for all instances in the acquisition. This provides the ability to rapidly and thoroughly analyze a long memory acquisition and calculate thousands or millions of parameter values, or find anomalous measurements. A variety of views are then provided allowing quick and easy measurement value understanding, as follows:

- **Histograms** provide a view of the measurement parameter distribution. See **Create and View a Histogram** (on page 99).
- **Tracks** provide a time-correlated view of a measurement parameter compared to other acquired channels or calculated math traces. A common usage for track is to observe the modulation of a signal, such as amplitude, frequency, or pulse width modulation. See **Creating a Track View** (on page 106).
- **Trends** provide a view of the measurement parameter over an extended period of time and over multiple acquisitions. See **Creating and Viewing a Trend** (on page 105).
- **Pass/Fail Testing** (on page 107) allows definition of the normal or abnormal measurement parameter value with a definable pass/fail action alerting the operator when a condition is met.
- **WaveScan** allows searching through a single acquisition for a measurement parameter that meets a variety of conditions, or scanning through multiple acquisitions with allowable trigger actions when conditions are met. In addition, a variety of views can be used to understand the specific behaviors of searched or scanned measurement parameters. See **Introduction to WaveScan** (on page 120).

These capabilities are only possible with the measurement of every occurrence of a measurement parameter in a long acquisition.

Both Track and Trend are tools that can be used to plot measurement data and observe variations with respect to time.

Differences between Track and Trend are summarized in the following table:

| Characteristic  | Track   | Trend   |
|---|---|---|
| Representation  | Parameter value vs. time  | Parameter value vs. event   |
| Behavior  | Non-cumulative (resets after every acquisition). Unlimited number of events                       | Cumulative over several acquisitions up to 1 million events   |
| Time Correlation to Other Data  | Yes   | No  |
| Monitors an Evolution in the Frequency Domain                               | Yes   | No. Trend points are not evenly spaced in time and therefore cannot be used for an FFT.   |
| Monitors the Evolution of a Measurement Parameter over Several Acquisitions | No. Track resets after every acquisition.   | Yes   |
| Ensures No Lost Measurement Data  | Yes. Maximum time period that can be captured is limited by acquisition memory and sampling rate. | No. Since data can be accumulated over many acquisitions, and since the oscilloscope takes time to calculate measurement values and to display data before the trigger is re-armed, data can be missed. |

In general, Track is the tool to use if you want to capture a continuous stream of data spaced closely together. To understand the change in a parameter with time, Trend can be used if your data is spaced widely apart and longer than the dead-time of the oscilloscope between acquisitions. Think of Trend as a strip chart recorder for your oscilloscope.

## Creating and Viewing a Histogram

Histograms are graphical representations of data which divides it into intervals or bins. These intervals/bins are plotted on a bar chart such that the bar height relates to the number of data points inside each interval/bin. Various histograms can be setup using **Measure** or **Math** dialogs. Thumbnail versions of Histograms are called **Histicons**. Also, **Persistence** can be applied to Histograms.

# WaveMaster 8 Zi/Zi-A Oscilloscopes

## PLEASE NOTE THE FOLLOWING:

The number of sweeps comprising the histogram is shown on the trace descriptor label:



The range of a histogram is limited to the portion of the trace that is visible on screen. That is, if you zoom in on a trace, the histogram does not contain data for that part of the original (no longer visible) trace.

## Single Parameter Histogram Setup

Setup a single parameter histogram can be done from Measure or Math dialogs. The following sections demonstrate both methods.

### SINGLE PARAMETER HISTOGRAM SETUP USING MEASURE

Touch **Measure** → **Measure Setup...** on the menu bar to access the Measure dialog. The **My Measure** button should be selected by default on the Measure dialog.

There are two ways to select parameters when setting up your measurement. They only differ in the order of the steps.

- **Using the Px Buttons on the Measure Dialog** - After directly touching a **Px** button on the **Measure** dialog, the **Select Measurement** pop-up is shown.

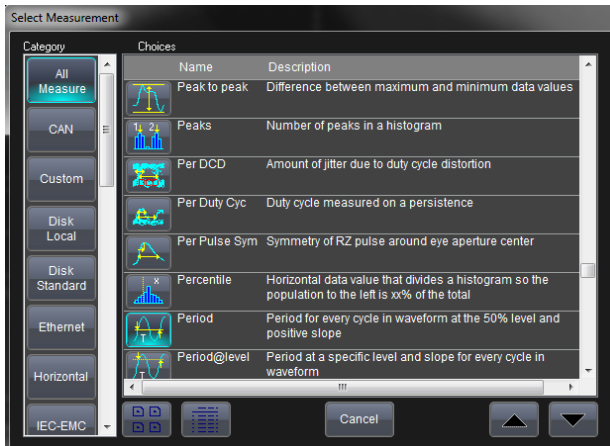

- **Using a Corresponding Px Tab/Dialog** - After directly accessing a corresponding **Px** dialog, touch the **Measure** control and the **Select Measurement** pop-up is shown.

Regardless of how you performed the previously described initial steps, at this point access your corresponding **Px** dialog to change other setup items as follows:

1. Touch inside the **Source1** control and select an input waveform from the **Select Source** window.
2. Touch inside the **Measure** field and select a parameter from the **Select Measurement** window.
3. Touch the **Histogram** button at the bottom of the dialog. After touching this button, the **Math selection for Histogram** pop-up is shown. Select the desired **Math Trace** in which to store the results. Touch the **Close** button when you are finished.

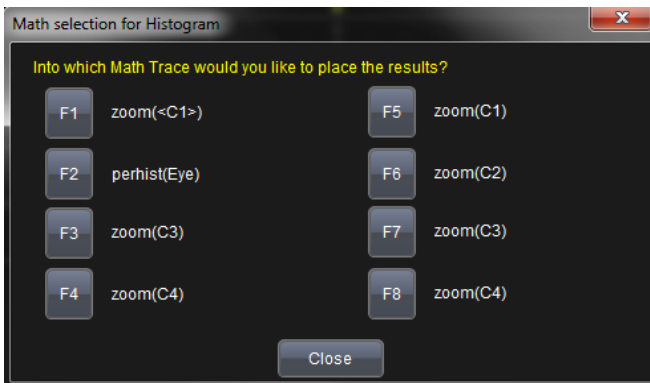

Touch the **trace descriptor label** for the math trace just created for the results, and then touch the **Histogram** tab to access its right-hand dialog.

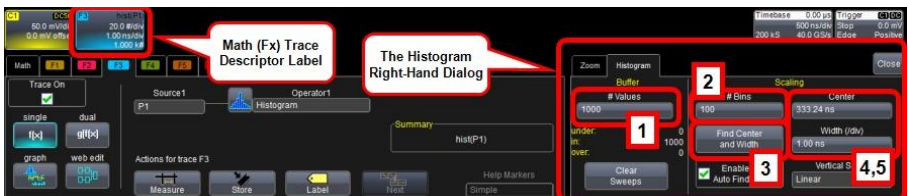

Numbers on the previous image correspond with the following explanations.

## WaveMaster 8 Zi/Zi-A Oscilloscopes

1. On the **Buffer** side of the **Histogram** right-hand dialog, touch **#Values** and provide a value.
2. On the **Scaling** side of the **Histogram** right-hand dialog, touch **#Bins** and provide a value.
3. Center the histogram by touching the **Find Center and Width** button.
4. Instead of using the **Find Center and Width** button, you can provide specific **Center** and **Width** values using their respective controls and providing values using the pop-up numeric keypad.

### SINGLE PARAMETER HISTOGRAM SETUP USING MATH

Access the main Math dialog by selecting **Math → Math Setup...** on the menu bar.

There are two ways to select your math operator during setup. They only differ in the order of the steps.

- **Using the Fx Buttons on the Math Dialog** - After directly touching an **Fx** button on the **Math** dialog, the **Select Math Operator** pop-up is shown.

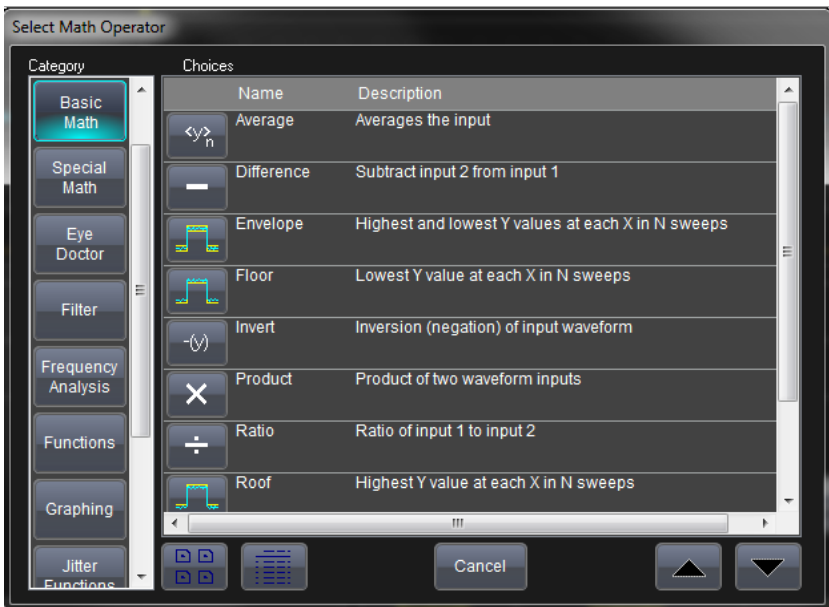

*Math functions are categorized into Basic and Special.*

- **Using a Corresponding Fx Tab/Dialog** - After directly accessing a corresponding **Fx** dialog, touch the **Operator** control and the **Select Math Operator** pop-up is shown.

Regardless of how you performed the previously described initial steps, at this point access your corresponding **Fx** dialog if you want to change other setup items as follows:

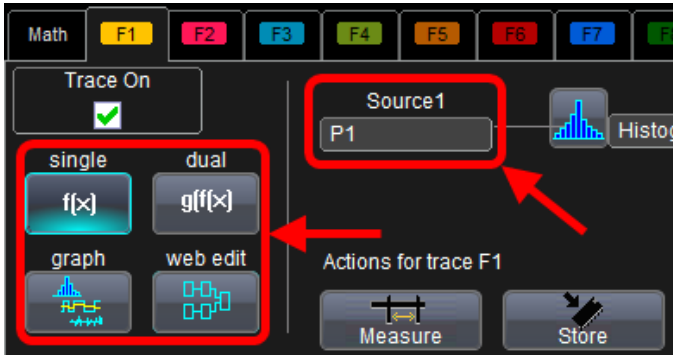

- You can modify the source of your waveform used on a Math trace using the **source (Source 1)** control.
- On the far left of the Fx dialog, the single and dual buttons are available for one math function or math-on-math, respectively.
- The **web edit** button is used to access the Processing Web and sequence highly-detailed math functionality.
- Touch the **Graph** button, and then touch inside the **Graph with** control to select a graph mode (in this case **Histogram**).

At this point, access the Histogram right-hand dialog by touching the Histogram tab on the far-right of the screen. Follow the final 1 - 4 steps in the previous **Single Parameter Histogram Setup Using Measure** instructions.

### **Viewing Thumbnail Histograms (Histicons)**

Histicons are miniature histograms of parameter measurements that appear below the grid. These thumbnail histograms let you see at a glance the statistical distribution of each parameter.

1. On the menu bar, touch **Measure**, then one of the Measure Mode buttons: **Std Vertical**, **Std Horizontal**, or **My Measure**.

## WaveMaster 8 Zi/Zi-A Oscilloscopes

2. Touch the **Histicons** checkbox to display thumbnail histograms below the selected parameters.

**Note:** For measurements set up in My Measure, you can quickly display an enlarged histogram of a thumbnail histogram by touching the Histicon you want to enlarge. The enlarged histogram appears superimposed on the trace it describes. This does not apply to **Std Vertical** or **Std Horizontal** measurements.

### *Persistence Histogram*

You can create a histogram of a persistence display also by cutting a horizontal or vertical slice through the waveform. You also decide the width of the slice and its horizontal or vertical placement on the waveform.

**Note:** This math operation is different than the Histogram math operation and is not affected by **Center** and **Width** settings made on any existing Histograms.

1. Touch **Math** → **Math Setup...** on the menu bar.
2. Either directly touch an **Fx** button on the Math dialog and select your Math Operator, or touch an **Fx** tab to show its corresponding dialog and touch the Operator1 dialog to select your Math Operator. Select **Phistogram** from the **Select Math Operator** pop-up.



3. With your math operator selected and the Fx dialog shown, touch inside the **Source1** field and select a source from the pop-up.
4. Touch the **Phistogram** tab to access its right-hand dialog. Now, touch the **Slice Direction** control and select **Horizontal** or **Vertical** slice from the pop-up.
5. Touch inside the **Slice Center** field and enter a value using the pop-up keypad.
6. Touch inside the **Slice Width** field and enter a value, using the pop-up keypad.



## Persistence Trace Range

Using this math operator, you can enter the percent of the persistence trace population to use in creating a new waveform.

**Note:** See previous sections for details around setting up a math trace and selecting your math operator if needed.

## Persistence Sigma

Using this math operation, you can enter a scale, measured in standard deviations, by which to create a new waveform.

## Creating and Viewing a Trend

1. In the menu bar, touch **Measure** → **Measure Setup...**
2. Touch one of parameter tabs **Px** showing its corresponding dialog.
3. Now, on the dialog, touch inside the **Source1** data entry field and select an input waveform from the pop-up menu.
4. Touch inside the **Measure** data entry field and select a parameter from the pop-up menu.
5. Touch the **Trend** button at the bottom of the dialog.

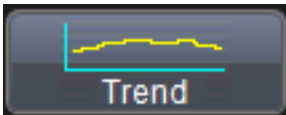

6. Now, from the **Math selection for Trend** menu, select a math function location **Fx** in which to store the **Trend** display. The Trend is then shown along with its respective trace descriptor label for the selected math function.

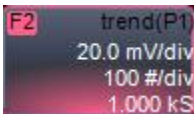

7. Touch the newly displayed Trend math function trace label to change settings on the Trend dialog (located on the Trend tab at the lower-right side of the screen).

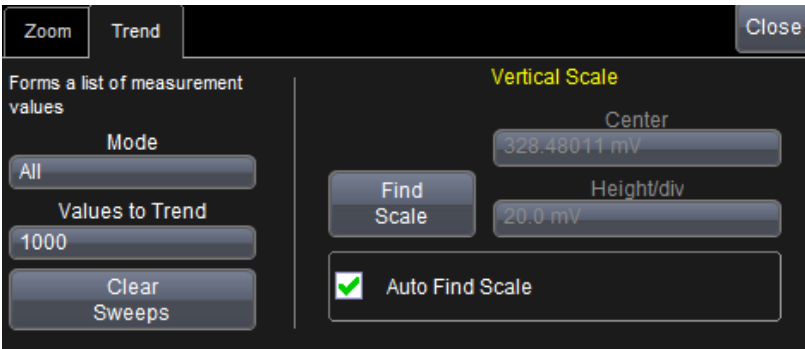

**Note:** Turning off a trace for which trend data is being collected resets the trend. If it is necessary to continue data collection for the trend, first create a zoom trace of the channel trace (before turning off the channel trace).

## Creating a Track View

1. In the menu bar, touch **Measure** → **Measure Setup...**
2. Touch a parameter tab **Px** and its corresponding dialog is shown.
3. Now, on the dialog, touch inside the **Source1** data entry field and select an input waveform from the pop-up menu.
4. Touch inside the **Measure** data entry field and select a parameter from the pop-up menu.
5. Touch the **Track** button at the bottom of the dialog.

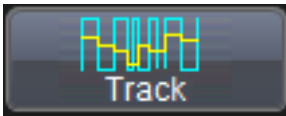

6. Now, from the **Math selection for Track** menu, select a math function location (**Fx**) on which to store the Track display.

The Track is then shown along with its respective trace descriptor label for the selected math function.

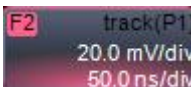

- Touch the newly displayed Track math function trace label if you want to change any settings in the **Track** dialog:

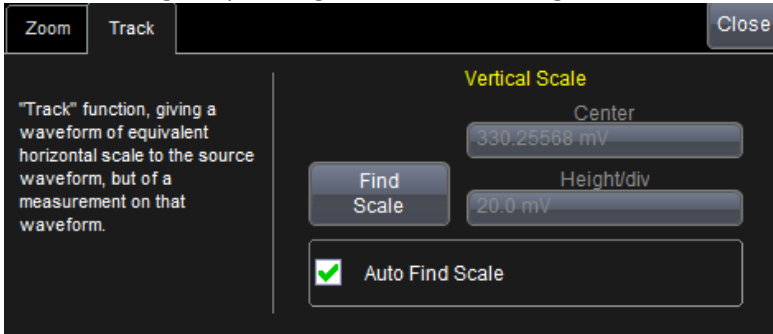

## Pass-Fail Parameter Testing

Access the main **Pass/Fail** dialog by selecting **Analysis → Pass/Fail Setup...** from the menu bar. The main **Pass/Fail** dialog is shown.

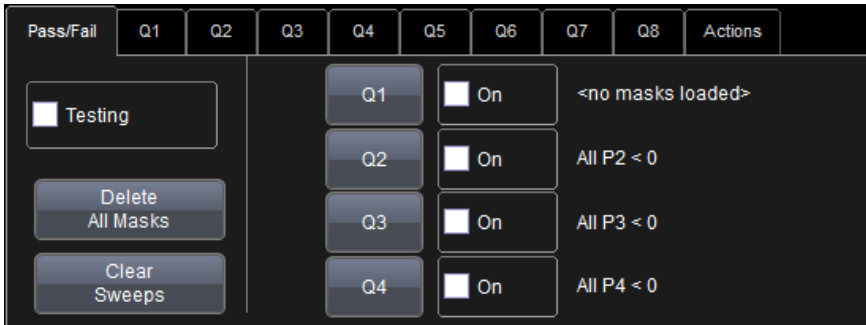

Access the respective **Qx** dialogs either by touching a **Qx** button on this main Pass/Fail dialog, or touching a **Qx** tab as described in *Displays Containing Masks* (on page 81).

When you have each of the **Qx** dialogs configured and enabled as desired, you can then begin your testing and turn them all on or off using the **Testing** checkbox on the main Pass/Fail dialog. You can also specify Actions for all or some of your conditions using the Actions dialog.

### ***Testing and Enabling Pass/Fail Conditions***

Beside each **Qx** button on the main Pass/Fail dialog is a corresponding **Qx** checkbox.

## WaveMaster 8 Zi/Zi-A Oscilloscopes

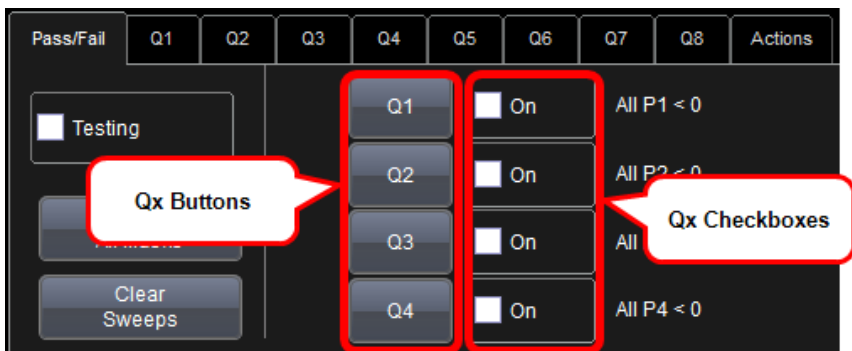

Use either these checkboxes or the ones on each respective **Qx** dialog to enable the specific condition for use.

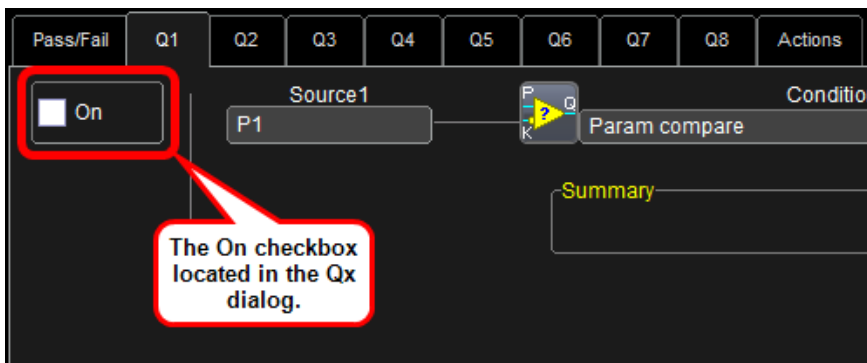

When you have each of the **Qx** dialogs configured and enabled as desired, you can then begin your testing and turn them all on or off using the **Testing** checkbox on the main Pass/Fail dialog.

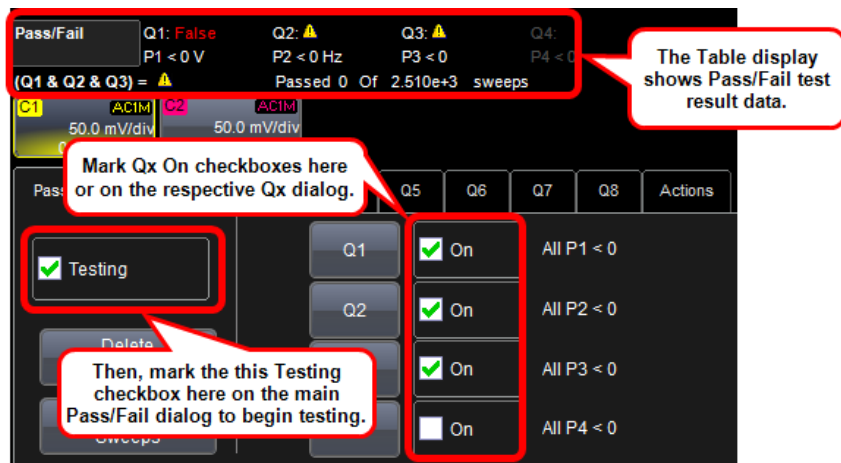

## Pass/Fail Setup on Qx Dialogs

The Qx dialog contains several controls for specifying your Pass/Fail setup.

### MAIN QX DIALOG CONTROLS

Use the **Source1** control to specify the waveform you'll use for your Condition.

Set your Pass/Fail condition by touching the **Condition** control on the corresponding Qx dialog. The Pass/Fail Condition pop-up is shown.

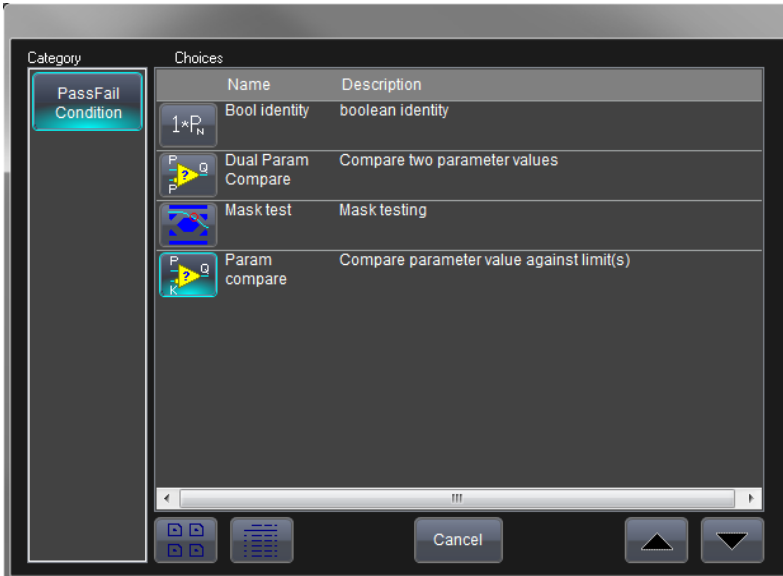

Select the desired condition.

**Note:** Right hand dialogs back on the corresponding Qx dialog vary based on the Pass/Fail condition selected.

The following sections cover the right hand dialogs for **Bool identity** and **Param and Dual Param Compare**. The **Mask test** condition is covered in **Mask Testing** (on page 117).

### CONDITION-BASED RIGHT-HAND DIALOGS

The following provide some explanation about the different Conditions and their respective right-hand dialogs.

#### Boolean Identity

This condition simply passes the input values through as the desired result.

#### Param and Dual Param Compare

## WaveMaster 8 Zi/Zi-A Oscilloscopes

Using the Param Compare conditions, each Pass/Fail input (**Qx**) can compare a different parameter result to a user-defined limit (or statistical range) under a different condition.

### COMPARING A SINGLE PARAMETER

1. With the ParamCompare condition selected on a Qx dialog, touch inside the **Compare Values** field and select **All** or **Any** from the pop-up menu.

By selecting **All**, the test are true only if every waveform falls within the set limit. Selecting **Any** makes the test true if just one waveform falls within the limit.

2. Touch inside the **Condition** field on the **ParamCompare** part of the dialog and select a math operator from the pop-up menu.



3. Touch inside the **Limit** field and enter a value using the pop-up numeric keypad. The value entered acquires the dimensions corresponding to the parameters being tested. For example, if you are testing a time parameter, the unit is seconds.



If you choose either **WithinDeltaPct** or **WithinDeltaAbs** from the **Condition** menu (respectively, previous), you also have the choice of setting the limit by means of the statistical buttons at the bottom of the **ParamCompare** dialog:

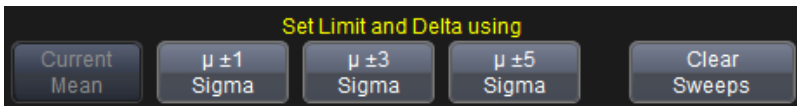

## COMPARING DUAL PARAMETERS

In **Dual Parameter Compare** mode, your oscilloscope can take parameter results measured on two different waveforms and compare them to each other. If desired, set your test to be true if **Any** or **All** waveforms fit the criteria set by the comparison condition. Setups are conveniently shown in the Summary box of the **Qx** dialog as follows (shown on the Dual Param Compare right-hand dialog):

### Summary

All  $P1 \leq P2$

1. Touch **Analysis** → **Pass/Fail Setup...** from the menu bar.
2. Touch one of the **Qx** tabs and a setup dialog for the position is shown.
3. Touch inside the **Condition** field in the main dialog and select **DualParamCompare**.



4. Touch inside the **Source1** and **Source2** fields and select a source from the pop-up menu.
5. Touch inside the **ParamCompare** mini-dialog field and select a source from the pop-up menu.
6. Touch inside the **Compare Values** field and select **All** or **Any** from the pop-up menu.

By selecting **All**, the test are true only if every waveform falls within the set limit. Selecting **Any** makes the test true if just one waveform falls within the limit.

7. Touch inside the **Condition** field on the **ParamCompare** part of the dialog and select a math operator from the pop-up menu.



## WaveMaster 8 Zi/Zi-A Oscilloscopes

8. Touch inside the **Limit** field and enter a value, using the pop-up numeric keypad. This value takes the dimension of the parameter that you are testing. For example, if you are testing a time parameter, the unit is seconds.
9. If you choose either **WithinDeltaPct** or **WithinDeltaAbs** from the **Condition** menu respectively, touch inside the **Delta** field and enter a value.

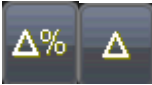

### The Actions Dialog

Various configurations can be made to all or some of your Pass/Fail conditions using the **Actions** dialog.

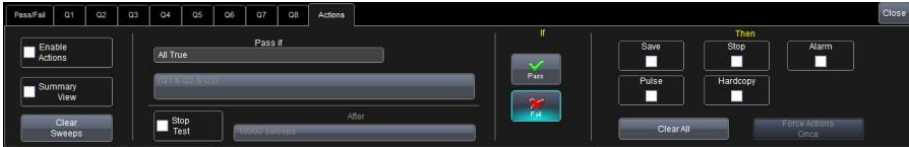

By touching the **Stop Test** checkbox in the **Actions** dialog, you can set up the test to end after a predetermined number of sweeps that you decide.

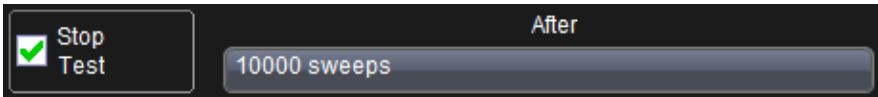

You can also decide the actions to occur upon your waveforms' passing or failing, by selecting one or all of the following:

- stop
- audible alarm
- print image of display
- emit pulse (if available)
- save waveform

The Pulse checkbox (shown right) causes a pulse to be output through the Aux Out connector at the front of the oscilloscope.



This pulse can be used to trigger another oscilloscope. You can set the amplitude and width of the pulse as described in Auxiliary Output Signals.



Depending on your oscilloscope model, you can configure up to 8 pass/fail conditions. The Boolean conditions to determine if your waveform passes are as follows:

| Pass/Fail Boolean Conditions        |                                      |
|-------------------------------------|--------------------------------------|
| All True                            | All False                            |
| Any True                            | Any False                            |
| All Q1 to Q4 <b>Or</b> All Q5 to Q8 | Any Q1 to Q4 <b>And</b> Any Q5 to Q8 |

## PASS/FAIL TESTING SETUP

### Initial Setup

1. Touch **Analysis** → **Pass/Fail Setup...** on the menu bar.
2. Touch the **Actions** tab.
3. Touch the **Enable Actions** checkbox. This causes selected actions to occur on your waveform's passing or failing a test.
4. Touch the **Summary View** checkbox to enable a line of text (as follows) showing a concise status of the last waveform and keeping a running count of how many sweeps have passed.

**Last = True** Passed 1 Of 1 sweeps ✓

5. Touch inside the **Pass If** control, and select a Boolean condition from the choices shown.
6. If you want to set up the test to end after a finite number of sweeps, touch the **Stop Test** checkbox. Then touch inside the **After** data entry control and provide a value using your preferred input control method. Additional information on using the touch screen controls can be found in the **Dialog Area** (on page 33).
7. Use either the **Pass** or **Fail** button on the **If** section of the dialog to set actions taking place when your waveform passes or fails the test.



8. The **Then** section of the dialog provides **stop test**, **sound alarm**, **print result**, **emit pulse**, or **save** (the waveform) actions. If you want to have the results printed (and your oscilloscope is not equipped with

## WaveMaster 8 Zi/Zi-A Oscilloscopes

---

a printer) make sure your instrument is connected to a local or network printer. Learn more in the **Printing and Hardcopy Functions** topic (available in the online help files).

9. If you want to save your waveform automatically, touch the **Save Setup...** checkbox. This takes you out of the current dialog and opens the **Save Waveform** dialog. Learn more in the **Save Recall → Saving and Recalling Waveforms** topic (available in the online help files).
10. Test Pass/Fail conditions by touching the **Force Actions Once** button. Press the **Clear All** button to quickly uncheck all checkboxes and make new selections.

# Math

## Overview

Teledyne LeCroy offers a deep toolset of math functions always growing and changing to provide superior functionality.

**Note:** To find out which math tools are available in each optional package or for any detailed explanations about specific functionality, it's always a good idea to check the more comprehensive online help onboard your instrument, datasheet materials regularly maintained on the Teledyne LeCroy website at [teledynelecroy.com](http://teledynelecroy.com).

**The extreme power of Teledyne LeCroy's math functions is most evident when used:**

- to perform mathematical functions on waveforms displayed on any channel **Cx**.
- to perform mathematical functions on waveforms recalled from memory **Mx**.
- as a source input waveform **Fx** in order to perform computations in sequence.
- as parameters **Px**.

**Instruments offering more than one math trace provide even more enhanced capabilities. For example:**

- setting up Trace F1 as the difference between Channels 1 and 2

- having trace F2 provide the average of F1
- having trace F3 provide the integral of F2
- go even further and display the integral of the averaged difference between Channels 1 and 2.

**You can even chain traces and/or functions to another trace or function.**  
**For instance:**

- making Trace F1 an average of Channel 1.
- making Trace F2 an FFT of F1.
- making Trace F3 a zoom of F2.

## Math Setup

Access the main Math dialog by selecting **Math** → **Math Setup...** on the menu bar.

There are two ways to select your math operator during setup. They only differ in the order of the steps.

- **Using the Fx Buttons on the Math Dialog** - After directly touching an **Fx** button on the **Math** dialog, the **Select Math Operator** pop-up is shown.
- **Using a Corresponding Fx Tab/Dialog** - After directly accessing a corresponding **Fx** dialog, touch the **Operator** control and the **Select Math Operator** pop-up is shown.

Regardless of how you performed the previously described initial steps, at this point access your corresponding **Fx** dialog if you want to change other setup items as follows:

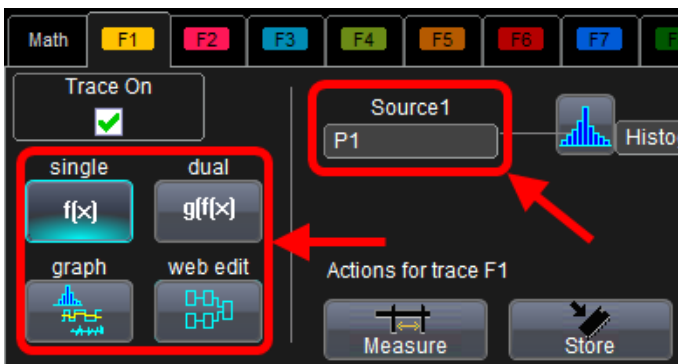

## WaveMaster 8 Zi/Zi-A Oscilloscopes

---

- You can modify the source of your waveform used on a Math trace using the **source (Source 1)** control.
- Touch the **Single** function button if you want to perform just one math function on the trace, or touch the **Dual** function button to perform math on math (shown respectively, as follows).



- Touch the **Graph** button, and then touch inside the **Graph with** control to select a graph mode.
- Use the **web edit** button to access the Processing Web and form sequence highly detailed math functionality.

# Mask Testing

Users may load or create a pixel-based mask on the display grid using a variety of methods. Test conditions can be set, and a pass/fail result returned based on whether the condition was found to be true or false. The source of the mask is always a trace (Channel, Zoom, Math waveform).

## Creating a Mask

1. After selecting Analysis → Pass/Fail, the Pass/Fail dialog is shown. Touch the **Q1** button.

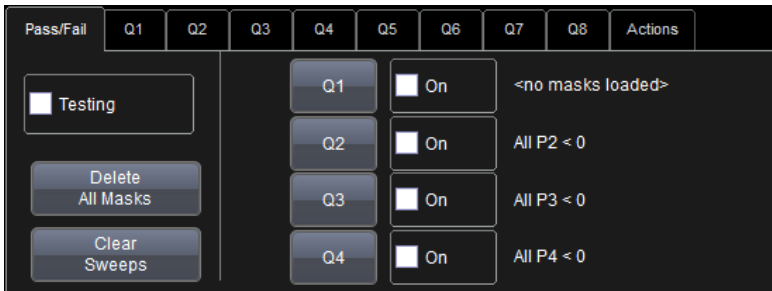

2. On the pop-up, select the **Mask test** Pass Fail Condition.

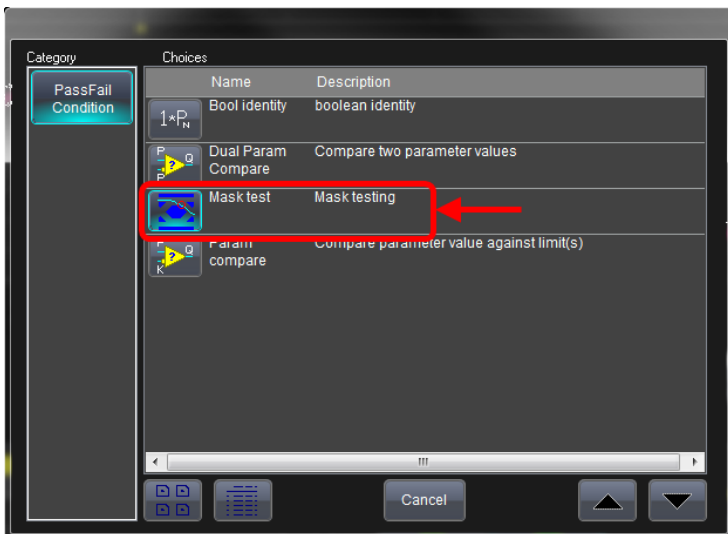

Now, the Q1 dialog is shown and shows the Mask test condition selected.

# WaveMaster 8 Zi/Zi-A Oscilloscopes

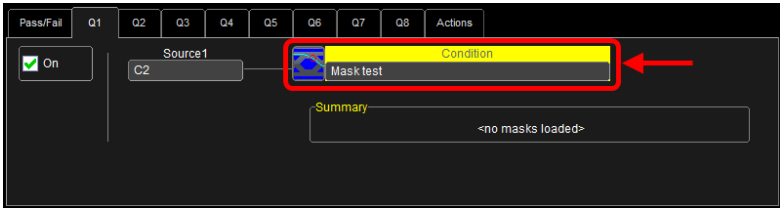

3. With the **Mask test** Pass Fail Condition selected, the **Test**, **Load Mask**, **Make Mask**, and **Gate** right-hand dialogs are shown and are where you manage, make, and apply gates to your mask.

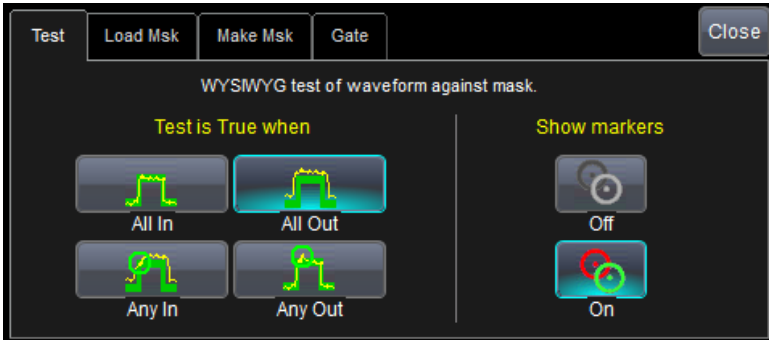

For more detailed information about these right-hand dialogs, refer to *Pass/Fail Testing* (on page 107).

## Quick Access to Pass/Fail Setup Dialogs

You can quickly gain access to the **main Pass/Fail** dialog, a **(Qx)** setup dialog, or the **Actions** dialog, by touching one of the following respective sections below the grid display.

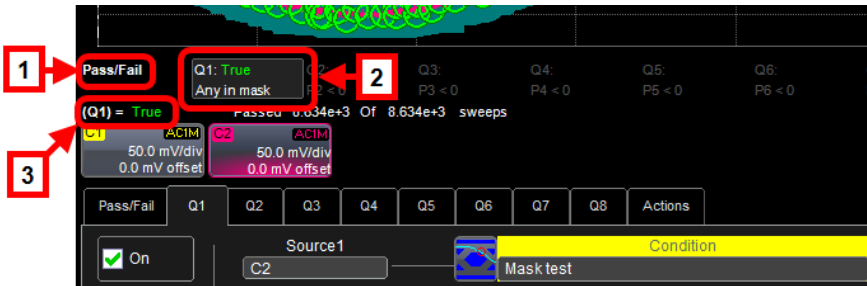

## Removing a Mask from the Display

Quickly remove a mask by accessing the **Qx** dialog. On the **Load Mask** right-hand dialog, click the **Delete** button.

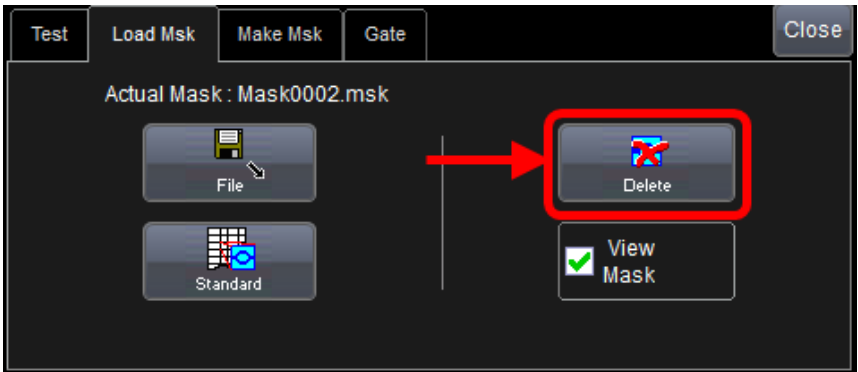

Mask testing can be done using an existing mask, or by using a mask created from your actual waveform, with vertical and horizontal tolerances that you define. Existing masks can be loaded from a floppy disk or from a network.

You can set your mask test to be True for waveforms All In, All Out, Any In, or Any Out. For example, if you select All In, the test becomes False if even a single waveform falls outside the mask.

Masks that you create from your waveform can be confined to just a portion of the trace by use of a measure gate. Refer to the **Measure Gate** online help topic for more information on how this feature works.

## Right-Hand Dialogs

- On the **Test** right-hand dialog, make a selection in the **Test is True when** group of buttons (as follows).



**Note:** The previous selection is for **All In** and means the test is False when a single waveform falls outside the mask.

From the **Show Markers** section of the dialog, choose whether or not to have mask violations displayed by touching either the **Off** or **On** button, respectively.

## WaveMaster 8 Zi/Zi-A Oscilloscopes

---

- When loading a pre-existing mask, use the **Load Mask** right-hand dialog. Using the **File** button, you can then enter the file name or browse to its location.
- When creating a new mask, use the **Make Mask** right-hand dialog. Touch the **Browse** button to create a file name and location for the mask if you want to save it.  
Touch inside the **Ver Delta** and **Hor Delta** fields and enter boundary values, using the pop-up numeric keypad. You can also use the **Make from Trace** button to instantly create a mask from a new waveform.
- When creating a new mask, use the **Make Mask** right-hand dialog.
- On the **Gate** right-hand dialog, you can enter values in the **Start** and **Stop** fields to constrain the mask to a portion of the waveform. Or, you can simply touch and drag the Gate posts, which initially are placed at the extreme left and right ends of the grid.

## WaveScan Overview

WaveScan enables you to search for unusual events in a single capture, or to scan for an event in many acquisitions over a long period of time. You can select from more than 20 search modes (frequency, rise time, runt, duty cycle, etc.), apply a search condition (slope, level, threshold, hysteresis), and begin scanning in a post-acquisition environment. Since the scanning modes are not simply copies of the hardware triggers, but software triggers, the capability is much greater.

For instance, there is no frequency trigger in any oscilloscope, yet WaveScan allows for quick frequency scans. You can accumulate a data set of unusual events separated by hours or days, enabling faster debugging. The events are time stamped, table indexed, and event rows can be selected for individual viewing.

You can also set actions to occur automatically when unusual events are found: stop the acquisition, emit an audible beep, output a pulse, print the screen, save waveforms to a file, or create a LabNotebook™ entry.



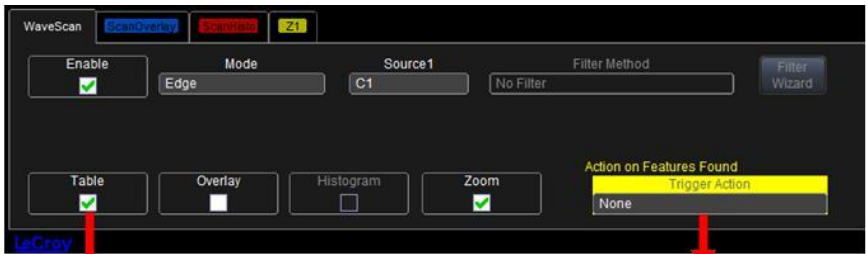

| Idx | Edge Time   |
|-----|-------------|
| 1   | -749.101 ns |
| 2   | -415.846 ns |
| 3   | -82.201 ns  |
| 4   | 250.898 ns  |
| 5   | 584.399 ns  |
| 6   | 918.099 ns  |



## Signal Views

- **Source View** highlights all occurrences of edges that meet your criteria.
- **Scan Overlay** places all captured edges one on top of the other in a separate grid. You can apply monochromatic persistence in this view.
- **Scan Histogram** provides a statistical view of edges that meet your search criteria.
- **Zoom View** allows you to expand a waveform feature vertically and horizontally; to apply further processing (using **Measure**); to **Store** it, or to apply a descriptive **Label** to the feature (as shown on the Actions portion of the trace dialog).



**Note:** The number of grids displayed varies from one to three grids depending on which views are enabled. WaveScan handles this function automatically, and there is no option to move traces from one grid to another, as would be the case under normal (non-WaveScan) operation.

### Search Modes

Use the **Mode** control to select an appropriate Search to locate anomalies during acquisition. When each of the following modes are selected, a corresponding right-hand dialog provides additional controls. The following modes are available:

- **Edge Mode** – Designed for detecting the occurrence of edges; selectable slope and level.
- **Non-monotonic Mode** – For detecting threshold re-crosses; selectable slope, hysteresis, and level.
- **Runt Mode** – For detecting pulses failing to cross a threshold; selectable polarity and thresholds.
- **Measurement Mode** – For filtering and performing parameter measurements.
- **Measurement Mode** – Searches from 2 to 64 bits; ideal for bursted patterns where a PLL cannot lock.
- **Bus Pattern Mode** – Searches from 2 to 64 bits; enhances MSO search capabilities.

### Parameter Measurements

Besides parameter measurements made during acquisition, post-acquisition measurements can also be made. The number of parameters available depends on the options loaded on your instrument.

Measurements are made only on the events defined by your filter (search criteria). A **Filter Wizard** is provided to quickly establish statistical criteria such as  $\pm 1$ , 3, or 5 sigma.

### Sampling Mode

Whenever WaveScan is enabled, the instrument reverts to Real-time sampling mode.

# Customization Overview

The instrument provides powerful capability to add your parameters, functions, display algorithms, or other routines to the oscilloscope user interface. You can customize the instrument to your needs by using the power of programs such as Excel™, Mathcad™, and MATLAB™, or by scripting in VBS. Whichever method you use, the results appear on the instrument's display together with the signals that you started with. This ability offers tremendous advantages in solving unique problems for a large range of applications, with comparatively little effort:

- Export data to programs, without leaving the instrument environment.
- Get results back from those programs, and display them on the instrument, without leaving the instrument application environment.
- Once the result is returned, perform additional oscilloscope operations, such as measuring with cursors, applying parameters, or performing additional functions on the waveform, in exactly the same way as for a normal waveform.
- Program the oscilloscope yourself.

The instrument does not just provide connectivity with data downloads to other programs. It provides true customizable interaction with these other programs, and allows you to truly customize the oscilloscope to do the exact job you want it to do. The advantages to this are many:

- Use the standard processing power of the instrument to do most of your calculations. You only need to write the function, parameter, display algorithm, etc. that specifically applies to your need and that the instrument doesn't contain.
- View the final result on the instrument display, and use all of the instrument's tools to understand the result.
- Do additional processing on the result by applying standard instrument parameters, functions, etc. to the returned result, or even more powerfully, adding chained customized functions. For example, you can do an Excel calculation on a result with a MATLAB function applied to it.

# Documenting Your Work Using LabNotebook

## Overview

Teledyne LeCroy's LabNotebook feature extends the documentation capabilities of your oscilloscope. It allows you to create an annotated notebook entry containing all displayed waveforms, the setup of the DSO, and user-supplied annotations. The notebook entry can then be converted to hardcopy format - .pdf, .rtf, or .html - and printed or e-mailed. You can also use the default report layout or configure your own, and even substitute your own company logo in the header.

Notebook entries are stored in an internal database and are available for recall at any time. Besides storing the waveform data, LabNotebook also stores your panel setups and parameter measurements. You can also back up the database to external media.

The Flashback feature allows you to recall the state of the DSO at a later date, including the saved waveforms and the DSO setup, so you can make additional measurements. A keyword filter makes it easy to find and recall a specific notebook entry.

You can choose which notebook to use for your entries, and label the notebook by project or user. This is especially useful if the oscilloscope is shared among several users and/or used for different projects as data can be kept separate how you see fit. Similarly, hardcopy reports can be stored in different folders.

**Note:** If your external monitor is connected, the LabNotebook automatically opens on the external monitor.

## LabNotebook Dialog

When LabNotebook is accessed by **File** → **LabNotebook** on the menu bar, the main **LabNotebook** dialog is shown by default.



This dialog is where you can **store** and **create** LabNotebook entries. You also can **View**, **Create**, **E-Mail**, and select an **output format** for your reports.

**Note:** Before creating a new Notebook Entry, you should first configure corresponding settings in **Preferences**.

1. Create a notebook entry by either:
  - Touching **File** → **Create Notebook Entry** on the menu bar.
  - Touching the **Create** button on the main LabNotebook dialog.
 Regardless, the **Enter Notebook Info** pop-up is shown where you can provide a title and comments for the entry. By default, the entry is titled with the current date and time.

 A screenshot of the 'Enter Notebook Info' dialog box. It has a title bar 'Enter Notebook Info' and two input fields:
 

- 'Enter Report Title:' with a text field containing '6/5/2008 11:07:05 AM'.
- 'Enter Report Description:' with a large, empty text area.

 At the bottom, there are three buttons: 'Save', 'Skip', and 'Cancel'.

2. Touch inside the **Title** control and provide a value.
3. If desired, touch the **Description** field and provide information.
4. Touch **Save**.

### PLEASE NOTE THE FOLLOWING:

- When an entry is first created and Report Title and Description information is provided, your new entry is shown along with **The Drawing Toolbar** at the top of the screen.
- When finished and the **Done** button is touched from the Drawing Toolbar, your new entry is shown on the **My Notebook Entries** list.

## Notebook Entries

**My Notebook Entries** list shows the entries you've already stored on your instrument. With a stored entry selected on the **My Notebook Entries** section of the dialog, you can do the following:

Touch the **Flashback (Recall)** button to return your instrument to the state it was in when the Notebook Entry was saved.

Exit Flashback by touching the **Undo Flashback** button in the top-right corner of the screen, or touch the Auto Trigger front panel control.

**PLEASE NOTE THE FOLLOWING:** The flashback feature currently recalls the DSO Setup, and all displayed waveforms. Some of result data is not recalled, including:

- **Persistence data** - While it is saved in hardcopy and is printed on the report, it is not recalled during Flashback.
- **Histogram data** - Histograms internally have a 32-bit resolution, but when stored into a trace file and recalled during flashback they are clipped to 16-bits.
- **Floating point waveforms** - Certain math operations result in the creation of floating point waveforms with much higher resolution than can be stored in a 16-bit waveform file. This extra resolution is not preserved when traces are recalled using flashback.
- **Cumulative Measurements** - Any measurements on when the Lab Notebook entry is created are not saved individually in the database (other than being embedded in the hardcopy image). This means that when flashback is used, the measurements are recomputed using the recalled waveform data. Normally, doesn't pose a problem; however, if cumulative measurements were on when the entry was stored and the cumulative measurements

accumulated data from multiple acquired waveforms, they lose their history and show instead only the results from the stored waveforms.

You can use the **Up** and **Down** arrows to move through your **My Notebook Entries** list one row at a time. If you have a large amount of entries, touch the **Filter** button and the **Filter Entries** pop-up is shown.

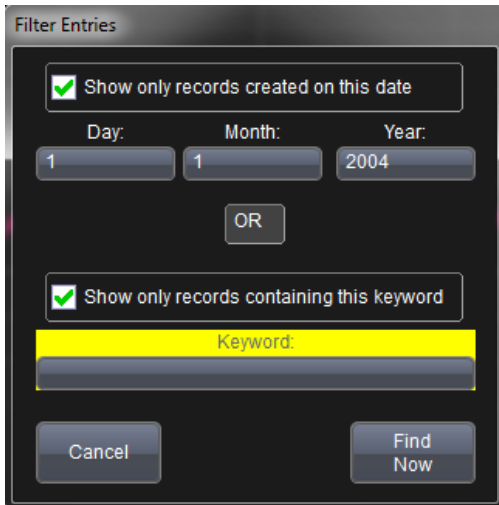

The image shows a 'Filter Entries' dialog box with a dark background. At the top, there is a title bar that says 'Filter Entries'. Below the title bar, there are two main filter sections. The first section is titled 'Show only records created on this date' and has a checked checkbox. Underneath, there are three input fields: 'Day:' with the value '1', 'Month:' with the value '1', and 'Year:' with the value '2004'. Below these fields is an 'OR' button. The second section is titled 'Show only records containing this keyword' and also has a checked checkbox. Below this is a text input field with the placeholder text 'Keyword:'. At the bottom of the dialog, there are two buttons: 'Cancel' on the left and 'Find Now' on the right.

Provide a **Date** and/or **Keyword** and touch the **Find Now** button to apply your filter to the **My Notebook Entries** list.

Use the **View**, **Create Report**, and **E-Mail** buttons as desired.

The **View** button shows a preview of your report.

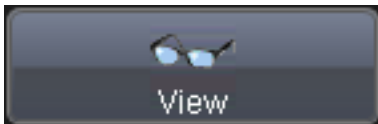

Exit the preview by touching the **Close** button at the right of the dialog.

Create your report by first touching inside the **Format** control and selecting a format from the pop-up.

Now, touch the **Create Report** button. In the **Create Report** window, select a folder to contain the report. Touch inside the **File name** control and enter a name using the pop-up keyboard. Click **OK** to create the report.

## WaveMaster 8 Zi/Zi-A Oscilloscopes

The **E-Mail** button automatically sends the report data to the account you've specified in Preferences. See, **E-Mail** (on page 153) for more information.

The **More Actions** button shows the **Specific Entry** dialog for the entry selected on the **My Notebook Entries** list. Using this dialog is explained in **Managing Notebook Entry Data** in the online help.

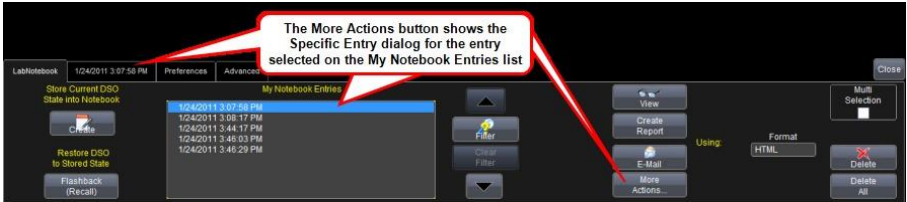

**Note:** Make personalized settings to your LabNotebook reports using .

You can select the **Format** of your LabNotebook entry from **HTML**, **RTF**, and **PDF** choices. The **Delete** button removes the specific row selected on the **My Notebook Entries** list while the **Delete All** button removes every entry on the list.

Marking the **Multi Selection** checkbox shows the **Select All**, **Clear All**, **Select**, **Clear**, and **Print** buttons.



The **Select All**, **Clear All**, **Select**, and **Clear** buttons are used to select/deselect multiple entries on the **My Notebook Entries** list. The **Print** button can only be used for Multi Selection printing of **My Notebook Entries** from the main LabNotebook dialog.

**Note:** If selected in **Preferences**, your entry can utilize **print colors**, printing on a white background instead of black.

Use the **Delete** button to delete the selected entry (or entries if the Multi Selection checkbox is marked). The **Delete All** button can be used to remove all notebook entries shown on the My Notebook Entries list with the touch of a single button.



# Save/Recall

## Overview

The **Save/Recall** section allows for storage and retrieval of **Waveforms**, **Table Data**, and **Instrument Setups**. It even provides **Disk Utilities** for arranging the file/folder structure on your instrument's hard drive.

Directly access each Save/Recall dialog (**Waveform**, **Table**, **Setups**, and **Disk Utilities**) on the **File** menu on the menu bar.

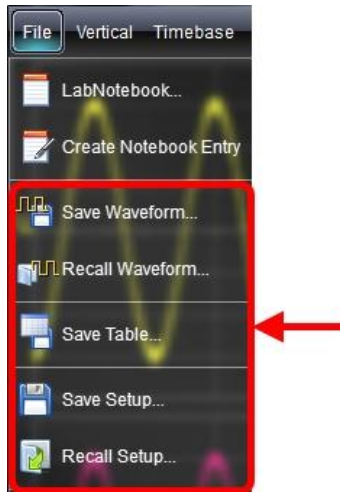

A main Save/Recall dialog is shown providing buttons to access the aforementioned dialogs for specific Save/Recall functions.



**Note:** While the **Disk Utilities** (on page 147) is the final dialog of these Save/Recall functions, it's actually considered part of the **Utilities** menu and is therefore covered in that section of the documentation.

### Saving and Recalling Setups

The Save/Recall Setup dialogs allow for quick saving and recalling of up to six oscilloscope panel settings internally on your instrument. If desired, you can also save and recall your oscilloscope panel settings as an .lss file to a specific hard disk location, a network location, or USB drive.

#### *Saving Oscilloscope Setup(s)*

Access the **Save Setup...** dialog by either selecting **File → Save Setup...** from the menu bar or clicking the **Save Instrument Setup** button on the main Save/Recall dialog. Now use one of the following two methods to save setup(s).

#### **SAVING SETUP(S) INTERNALLY ON YOUR INSTRUMENT**

Save your settings **internally on your instrument** by touching inside one of the six **SetupX** data entry controls on the **Save to Internal Setup...** part of the screen and providing a name. Now, touch its corresponding **Save** button directly to the left.

Your setup file is then saved to the **D:\Internal Setups** location on your instrument and the current date/time is shown above the **SetupX** data entry control.

#### **SAVING SETUP(S) DIRECTLY TO A FILE**

Save your setup(s) **directly to a file** by touching the **File** button on the **Save To** section on the dialog. Now, touch inside the **Save files in directory** control and provide a path to the destination folder. Or touch **Browse** to navigate to the destination folder. Finally, touch the **Save Now** button.

#### *Recalling Oscilloscope Setup(s)*

Access the **Recall Setup...** dialog by either selecting **File → Recall Setup...** from the menu bar or clicking the **Recall Instrument Setup** button on the main Save/Recall dialog. Now use one of the following two methods to save setup(s).

#### **RECALLING SETUP(S) INTERNALLY ON YOUR INSTRUMENT**

Recall your settings located **internally on your instrument** by touching inside one of the six **Recall** buttons on the **Recall From Internal Setup...** part of the screen.

Each Recall button is labeled with a corresponding setup storage slot. If a setup is stored, **SetupX** is shown along with the **date/time of the save**, otherwise, the slot is labeled **Empty**.

## RECALLING SETUP(S) DIRECTLY FROM A FILE

Recall your setup(s) **directly from a file** by using controls on the **Recall From File** section on the right side of the dialog. Touch inside the **Recall panel from file** data entry control and provide a path to the destination folder. Or touch **Browse** to navigate to the destination folder. Finally, touch the **Recall Now** button.

## Recalling Default Settings

Your instrument's default settings can be recalled at any time using the **Recall Default** button.

## Saving and Recalling Waveforms

### Saving Waveforms

The Save Waveform dialog is used to save displayed waveforms to either a memory trace or to text or binary file formats.

Access the **Save Waveform** dialog by either selecting **File → Save Waveform** from the menu bar or clicking the **Save Waveform** button on the main Save/Recall dialog.



Use the numbered sections of this Save Waveform dialog, which correspond with the following explanations, to properly save your waveform(s).

1. Select either **Memory** or **File** by touching either respective button on the **Save To** portion of the dialog.

**Note:** When **Memory** is selected, only **Source** and **Destination** controls are shown on the Save Waveform dialog. When **File** is selected, many more controls are available. Regardless, the controls are used as explained in the following steps.

## WaveMaster 8 Zi/Zi-A Oscilloscopes

2. Touch inside the **Source** control and select a source from the **Select Source** pop-up. The source can be any trace; for example, a channel (C1–C4), math function (F1–F4), or a waveform stored in non-volatile RAM (M1–M4).
3. **Destination** - Click to show the available memory traces when saving to memory.
4. Touch inside the **Trace Title** data entry control to change the default name of your waveforms (if desired).

**Note:** You can change the name but not the sequence number.



**CAUTION.** If you use a name ending with a number instead of a letter, the instrument may truncate the number. This is because, by design, the first waveform is automatically numbered 0, the second 1, and onward. For example, if you want to use waveform name **XYZ32** but it is not preceded by waveforms XYZ0 through XYZ31, the waveform is renumbered with the next in sequence. If you need to use a number in your waveform's name, append an alpha character at the end of the number: **XYZ32a**, for example.

5. If you are saving to a file, touch the **Data Format** control and select a format type.
  - **Binary** - saves the file to Teledyne LeCroy's binary file format. This format is documented in various Remote Control Manuals for Teledyne LeCroy Oscilloscopes. Selecting **Binary** results in the smallest possible file size, and is recommended when recalling waveforms to Teledyne LeCroy instruments.

**Note:** Binary files can be converted to ASCII using Teledyne LeCroy utilities such as **ScopeExplorer** or **WaveStudio**.

- **ASCII** -Text output file (.txt extension).
  - **MATLAB** - Text output file compatible with MATLAB (.dat extension).
  - **Excel** - Text output file compatible with Excel (.csv extension).
  - **MathCad** - Text output file compatible with Excel (.prn extension).
6. Depending on your selection, you may need to touch the **SubFormat** control and select a subformat.

- **Word** - Available when selecting the Binary format, specifies the samples in the output file are represented with 16 bits. Always use this option unless Byte mode is pre.
- **Byte** - Available when selecting Binary format, specifies the samples in the output file are represented with 8 bits.

**Note:** This option can result in a loss of output file resolution.

- **Amplitude only** - Specifies the output file include amplitude data for each sample, but not sample time information.
- **Time and Amplitude** - Specifies the output file include both time and amplitude data for each sample.
- **With Header** – Available with the Vector Signal Analysis option, this includes a header with scaling information. This stores the waveform in **VSA recall** format for later use.

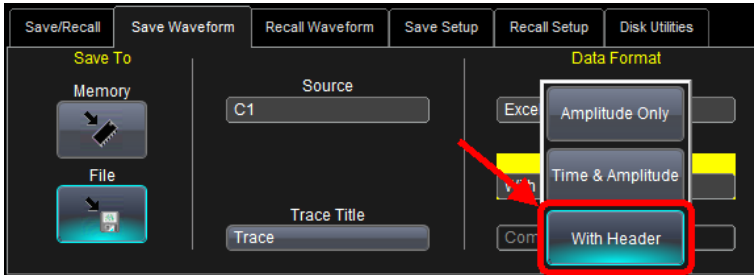

### PLEASE NOTE THE FOLLOWING:

- Select **Audio** to save your waveforms in .wav format.
  - The **WaveML** format, which enables XML output, is used for persistence traces.
7. If you selected **ASCII**, touch the **Delimiter** control and select a delimiter character from the pop-up menu. Choose from **comma**, **space**, **semicolon**, or **tab** delimiters.
  8. You can use the **Auto Save** feature to automatically save a waveform to disk after each new trigger.
  9. Enable Auto Save from the **Save Waveform** dialog by touching one of the **Auto Save** buttons.
  10. Select **Wrap** (old files overwritten) or **Fill** (no files overwritten).



**CAUTION.** Selecting Fill can quickly use up all the hard disk space on your instrument.

## WaveMaster 8 Zi/Zi-A Oscilloscopes

11. Touch the **Browse** button next to the **Save file in directory** control and navigate to the location where you want the file saved. The file name is assigned automatically and is shown under the control.
12. Finally, touch the **Save Now!** button.

### Recalling Waveforms

**Note:** Only .trc files saved in binary format can be recalled into the oscilloscope.

Access the **Recall Waveform** dialog by either selecting **File → Recall Waveform** from the menu bar or clicking the **Recall Waveform** button on the main Save/Recall dialog.



Use the numbered sections of this Recall Waveform dialog, which correspond with the following explanations, to properly recall your waveform(s).

1. Select either **Memory** or **File** by touching either respective button on the **Recall From** portion of the dialog.

**Note:** When **Memory** is selected, only **Source**, **Destination**, and **Show on recall** controls are shown on the Recall Waveform dialog. When **File** is selected, many more controls are available. Regardless, the controls are used as explained in the following steps.

2. If recalling from Memory, touch inside the **Source** control and select a source stored in non-volatile RAM (M1–M4) from the **Select Source** pop-up.
3. Touch inside the **Destination** control and select a location for storage (memory or file) from M1 to M4.
4. **Show on Recall** - Mark this checkbox to have the memory trace shown on the grid display after recalling the waveform.

5. When saving a File, touch inside the **Show only files** control and select an area to limit the search (**channels, math functions, or memory**).
6. Touch inside the **Recall files from directory** data entry control and provide the path. You can also touch the **Browse** button and navigate to the file. Touch inside the **Next file will be recalled from data entry** control and provide the path or, touch the **Browse** button to navigate to the file.
7. **Up /Down arrows** - Use these buttons to cycles through files in the selected folder from the **Show only files** control.
8. When finished, touch the **Recall Now!** button.

## Utilities

### Overview

Utilities settings are divided into two main groups: **Utilities Setup** and **Preferences Setup**. The Utilities menu also has shortcuts to **Disk Utilities** (File Menu functions) and **Calibration Setup** (also found in Preferences).

### Utilities Setup

Selecting **Utilities** → **Utilities Setup...** shows the main **Utilities** dialog by default. The following controls are available from this dialog:

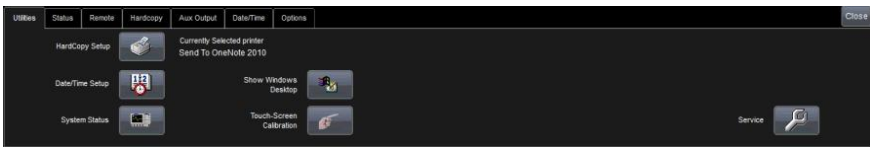

- The **HardCopy Setup**, **Date/Time Setup**, and **System Status** buttons all open their corresponding dialogs.

**Note:** To the right of the **HardCopy Setup** button, display text indicates your currently selected printer for convenience.

- When touched, the **Show Windows Desktop** button instantly minimizes the oscilloscope (and any other) applications.

Maximize the application by touching the shortcut icon located on the lower-right of the screen.



- A sequence of calibration screens are shown when the **Touch-Screen Calibration** button is touched. These screens instruct you to touch a series of displayed crosses in order to improve precision and accuracy when using your touch screen.



### PLEASE NOTE THE FOLLOWING:

- Use a stylus for this procedure. Using your finger for the calibration prompts provides insufficient accuracy for the procedure.
- The calibration procedure times out after ten seconds pass and no cross is touched.
- Avoid parallax errors by placing your line of sight directly in front of each cross before touching it.
- The **Service** button is a section of the application reserved for qualified Teledyne LeCroy personnel. When touched, an access code pop-up is shown enabling Teledyne LeCroy technicians access to various service dialogs inside the oscilloscope software.

To learn more, **Contact Teledyne LeCroy for Support.**

## Status

Control values are shown for information about your instrument. Among them include your Hardware and Software options.

View the oscilloscope's system status (including software and hardware configurations) on this Status dialog. The dialog displays read-only system information including **model number**, **serial number**, **firmware version**, and **installed software and hardware options**.

New software options can be added after purchasing a code and then enabling the option on the oscilloscope. Call Teledyne LeCroy Customer Support to place an order and receive the code.

- After adding new software options, the entire oscilloscope application needs to be restarted. Do this by touching the desktop shortcut.



- Restart the Windows® operating system on your instrument (if necessary) by rebooting the oscilloscope. Do this by pressing the power switch, and then turning the power back on after a ten-second wait.

Upon initial power-up, the oscilloscope automatically loads the instrument application software along with any additional software options.

### **Remote Communication**

Use the **Remote** dialog to setup remote communication. You can select a network communication protocol, establish network connections, and configure the Remote Control Assistant log from the **Remote** dialog. The choice of communication protocols is limited to TCP/IP, GPIB, and USB488 (on specific models).

#### **PLEASE NOTE THE FOLLOWING:**

- GPIB is an option that either requires a GPIB card to be installed in an open card slot on your oscilloscope or the use of an external USB to GPIB Teledyne LeCroy accessory. Your particular oscilloscope may support both, or only one of the options/accessories. For more information about which Teledyne LeCroy GPIB options and accessories your oscilloscope supports, **Contact Teledyne LeCroy for Support.**
- The instrument uses Dynamic Host Configuration Protocol (DHCP) as its addressing protocol. Therefore, it is not necessary to set up an IP address if your network supports DHCP. If it does not, you can assign a static address in the standard Windows network setup menu.

The Remote Control Assistant monitors communication between your PC and oscilloscope when you are operating the instrument remotely. You can log all events or errors only. This log can be invaluable when you are creating and debugging remote control applications.

#### **REMOTE COMMUNICATION SETUP**

If you are connecting the oscilloscope to a network, first contact your Information Systems administrator. If you are connecting the oscilloscope directly to your PC, connect a GPIB or Ethernet cable between them.

1. On the **Remote** dialog, make a **Port** selection: **TCP/IP** (transmission control protocol/Internet protocol) or **GPIB** (general purpose interface bus). If you do not have a GPIB card installed, the GPIB selection will not be accessible.
2. If you are using GPIB, set a GPIB address by touching inside the **GPIB Address** data entry control and provide an address.

**OR**

If you are using TCP/IP, press the **Net Connections** button; the Windows **Network Connections** window opens. You can reconfigure

the oscilloscope's connection if it is already connected to the network or make a new connection.

**Note:** Your instrument allows you to restrict remote control access to certain clients. To restrict access, under **Security**, touch the **Yes** button and enter the IP addresses or domain name server names you want to restrict separated by a comma.

### CONFIGURING THE REMOTE CONTROL ASSISTANT EVENT LOG

1. Under **Remote Control Assistant**, touch inside the **Log Mode** data entry control. Select **Off**, **Errors Only**, or **Full Dialog** from the pop-up menu.
2. Export the contents of the event log to an ASCII text file by touching the **Show Remote Control Log** button. The **Event Logs** pop-up is shown. Touch inside the **DestFilename** data entry control and provide a file name using your preferred input control method. Additional information on using the touch screen controls can be found in the **Dialog Area** (on page 33).

Then, touch the **Export to Text File** button.

### *Printing and Hardcopy Functions*

Your instrument provides the ability to output files to printers or plotters print to file, or e-mail your files. Any Microsoft Windows® supported printer is supported by your instrument.

#### PRINTER SETUP

1. Touch **File** → **Print Setup...** on the menu bar. The Utilities **Hardcopy** dialog opens.

**OR**

Press the PRINT front panel button. Then, touch the **Print Setup...** button on the **Print** flyout menu.

**OR**

Touch **Utilities** → **Utilities Setup...** and click the **Hardcopy** tab.

2. On the Hardcopy dialog, touch the **Printer** icon.



3. Under **Colors**, touch the **Use Print Colors** checkbox if you want the traces printed on a white background.

## WaveMaster 8 Zi/Zi-A Oscilloscopes

**Note:** A white background saves printer toner. (You can change the printer colors in the **Utilities → Preference Setup → Color** dialog.)

4. Touch inside the **Select Printer** control and choose a printer from the pop-up menu.
5. Touch the **Properties** button to see your printer setup.
4. Touch the icon for the layout **Orientation** you want: portrait or landscape.
5. Touch the **Hardcopy Area** control to choose which part of the screen you want to print from the pop-up menu.

Choose **Grid Area Only** if you do not need to print the dialog area and you only want to show the waveforms and grids. Choose **DSO window** if you want to print the dialogs with the waveforms and grids. Choose **Full Screen** if you want to print the entire screen.

### ADDING PRINTERS AND DRIVERS

**Note:** If you want to add a printer driver, the driver must first be loaded on the oscilloscope.

1. Touch **File → Print Setup...** on the menu bar.

**OR**

Press the PRINT front panel button. Then, touch the **Print Setup...** button on the **Print** flyout menu.

**OR**

Touch **Utilities → Utilities Setup...** and click the **Hardcopy** tab.

2. On the Utilities **Hardcopy** dialog, touch the **Printer** icon.



3. Touch the **Add Printer** button. A Microsoft Windows® Printer window opens where you can add a printer.

## PRINT TO CLIPBOARD



The **Clipboard** selection on the **Hardcopy** tab saves the screen image on the clipboard so you can paste a file into another application (like Microsoft Word, for example).

1. Touch **Utilities** → **Utilities Setup...** and click the **Hardcopy** tab. On the Hardcopy dialog, touch the **Clipboard** button.
2. Touch the **Colors** control and choose **Standard** to print the screen as it appears, **Print** to print the waveforms on a white background, or **Black & White** to print the waveforms in black & white.
3. **Note:** Choosing **Print** colors saves printer toner or ink.
4. Touch the **Hardcopy Area** control to choose which part of the screen you want to print. Choose **Grid Area Only** if you do not need to print the dialog area and you only want to show the waveforms and grids. Choose **DSO window** if you want to print the dialogs with the waveforms and grids. Choose **Full Screen** if you want to print the entire screen.
5. To print immediately, touch the **Print Now** button.

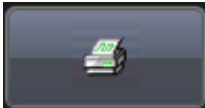

## PRINT TO FILE



The **File** selection on the **Hardcopy** tab saves screen images as a file to storage media such as a USB drive or hard drive.

1. Touch inside the **File Format** data entry control and select a graphic file format from the pop-up menu.
2. Touch the **Colors** control and choose **Standard** to print the screen as it appears, **Print** to print the waveforms on a white background, or **Black & White** to print the waveforms in black & white.

**Note:** Choosing **Print** colors saves printer toner or ink (when you eventually do print from the file).

## WaveMaster 8 Zi/Zi-A Oscilloscopes

3. Touch inside the **File Name** data entry control and provide a name for the display image using your preferred input control method. Additional information on using the touch screen controls can be found in the **Dialog Area** (on page 33).
4. Touch inside the **Directory** data entry control and provide the folder path for the resulting printout. Or touch the **Browse** button and navigate to the folder.

### SENDING TO E-MAIL



The **E-mail** selection on the **Hardcopy** tab gives you the option to e-mail your screen images, using either the MAPI or SMTP protocols.

1. Touch **Utilities** → **Utilities Setup...** and click the **Hardcopy** tab. On the Hardcopy dialog, touch the **E-Mail** button.
2. Touch inside the **File Format** data entry control and select from the pop-up menu.
3. Touch the **Colors** control and choose **Standard** to print the screen as it appears, **Print** to print the waveforms on a white background, or **Black & White** to print the waveforms in black & white.

**Note:** Choosing **Print** colors saves printer toner or ink (when you eventually do print from the file).

4. Touch the **Prompt for message to send with mail** checkbox if you want to include remarks with the image.
5. Touch the **Hardcopy Area** control to choose which part of the screen you want to print. Choose **Grid Area Only** if you do not need to print the dialog area and you only want to show the waveforms and grids. Choose **DSO window** if you want to print the dialogs with the waveforms and grids. Choose **Full Screen** if you want to print the entire screen.
6. Touch the **Print Now** button.



### PRINTING A SCREEN IMAGE

After the Hardcopy settings are configured, you can print in any of these ways, and the image will be handled according to your desired output type:

- Press the **PRINT** front panel button. Then, touch the **Print Now** button on the **Print** flyout menu.



- Touch **File** → **Print** on the menu bar.
- Touch **Utilities** → **Utilities Setup...** and click the **Hardcopy** tab.

On the **Hardcopy** dialog, touch the **Print Now** button.



## Aux Output

The **Aux Output** dialog allows you to specify Auxiliary and Calibration Output details.



1. If you want a specialized output, touch one of the following buttons under **Use Auxiliary Output For: Square Wave, Trigger Enabled, Trigger Out, Pass/Fail, or Off.**

**Note:** If **Pass/Fail** is selected on this **Use Auxiliary Output For** section of the dialog, a **Pulse Duration** data entry control is made available. Provide a value within your instrument's specified range (varied based on your specific model, refer to datasheet specifications at [teledynelecroy.com](http://teledynelecroy.com) for details) using your preferred input control method. Additional information on using the touch screen controls can be found in the **Dialog Area** (on page 33).

2. On the **Use Calibration Output For** section of the dialog, choose **Square, DC Level, or Off**. If you want a 1 kHz, 1 V Square Wave, touch the **Set to 1 kHz, 1 V Square Wave** button.

Additional controls are made available based on **Square** or **DC Level** selections as follows:

- If you selected **Square** on the **Use Calibration Output For** section of the dialog, a **Frequency** data entry control is made available. You can set a value using your preferred input control method.
- If you selected **Square** or **DC Level** on the **Use Calibration Output For** section of the dialog, an **Amplitude into 1 MΩ** data entry control is made available. Provide a desired value using your preferred input control method.

## AUXILIARY OUTPUT SIGNALS



A calibration signal and the following additional signals can be output through the connector labeled **AUX OUT** on your oscilloscope. Use the Auxiliary Output to send the following signals to other instruments:

- **Trigger Enabled** - This function can be used as a



gating function to trigger another instrument when the oscilloscope is ready.

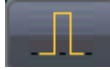

- **Trigger Out** - This function can be used to trigger an external oscilloscope.



- **Pass/Fail** - Allows you to set a pulse duration (varied based on your specific model, refer to datasheet specifications at [teledynelecroy.com](http://teledynelecroy.com) for details); generates a pulse when pass/fail testing is active and conditions are met.



- **Fast Edge** - Some models provide this signal output used to deskew multiple channels. The Fast Edge connection varies based on model and is either SMA or BNC.



### CALIBRATION OUTPUT SIGNALS

A calibration signal can be output from the Probe Calibration Hook on the front of the oscilloscope. The following Calibration Output Signals are available for use:

- **Square Wave** - You can set a Frequency value (varied based on your specific model, refer to datasheet specifications at [teledynelecroy.com](http://teledynelecroy.com) for details).



- **DC Level** - This is a reference level.



- **Off** - This function turns off the Auxiliary Output signal.



### **Date/Time**

From the **Date and Time** tab on the **Utilities** dialog, you can manually set the time and date or get it from the Internet. If you elect to get the date and time from the Internet, you need to have the oscilloscope connected to the Internet through the LAN connector on your instrument's I/O panel. You can also set time zones and daylight savings time.

1. You can **set the Date and Time manually** by providing a value in the **Hour, Minute, Second, Day, Month, and Year** using your preferred input control method. Additional information on using the touch screen controls can be found in the **Dialog Area** (on page 33). After providing values, touch the **Validate Changes** button.
2. You can **set the Date and Time from the Internet** by first verifying that your oscilloscope is connected to the Internet, and then touching the **Set from Internet** button.

**Note:** The Simple Network Time Protocol (SNTP) is used.

3. You can also set the Date and Time using Windows® by touching the Windows Date/Time button. Windows shows a **Date and Time Properties** pop-up where the date and time can be configured.

### **Options**

The Options dialog is used to add or remove software options. To learn more, visit our Website at [teledynelecroy.com/options](http://teledynelecroy.com/options).

This dialog also shows your **ScopeID** and **Serial #**.

## Disk Utilities

Use the Disk Utilities dialog to arrange the file/folder structure on your instrument's hard drive. You can delete files, folders, or create new folders.

**Note:** All Disk Utilities can also be accomplished using the standard Microsoft Windows® file management tools.

Access the **Disk Utilities** dialog by selecting **Utilities** → **Disk Utilities** from the menu bar.



1. **Delete a single file** by first touching the **Delete** button on the dialog (just to make sure it's selected).
  - Now, touch inside the **Current folder** data entry control and provide the path to the folder containing the file for deletion.  
**OR**  
Touch the **Browse** button and navigate to the folder.
  - Touch inside the **File to be deleted** data entry control and provide a file name using your preferred input control method. Additional information on using the touch screen controls can be found in the **Dialog Area** (on page 33).  
**OR**  
Touch the **Browse** button and navigate to the file.

**Note:** You can also use the **up down arrows** to move through the files contained in the **Current folder** selected.

With the desired file for deletion located, touch the **Delete File** button.

2. **Delete all files in a folder** by repeating the aforementioned **Delete a single file** process (up to the first bullet only using the **Current Folder** control).

With the desired folder for deletion located, touch the **Empty Folder** button.

# WaveMaster 8 Zi/Zi-A Oscilloscopes

3. **Create a Folder** by first touching the **Create** button on the dialog (just to make sure it's selected).
  - Touch inside the **Current folder** data entry control and provide the path for folder creation and **be sure to include the folder name**.
  - Now, touch the **Create Folder** button.

**Note:** **Disk Space** data for **Size**, **Free**, and **File(s)** is available on the far right of the dialog for convenience.

## Preferences Setup

### Overview

A variety of customizable preferences can be set on your instrument. Access Preferences by touching **Utilities** → **Preference Setup...** on the menu bar. The main **Preferences** (below) dialog is shown by default with the following additional, tabbed dialogs also available:

- **Calibration**
- **Acquisition**
- **E-Mail**
- **Color**
- **Miscellaneous**

### Preferences

Selecting **Utilities** → **Preference Setup...** shows the main **Preferences** dialog by default. The following controls are available from this dialog:



Numbers on this image correspond with the following explanations.

1. You can choose to have audible confirmation each time you touch a screen or front panel control by marking the **Enable** checkbox on the **Audible Feedback** section of the dialog. With Audible Feedback enabled, the oscilloscope beeps each time you touch the screen or a front panel control.

2. You can choose to have your instrument automatically re-calibrate itself whenever there is a significant change in ambient temperature by marking the **Enable** checkbox on the **Automatic Calibration** section of the dialog.

**Note:** If you do not enable this option, the oscilloscope re-calibrates only at startup and whenever you make a change to certain operating conditions.

3. If the option is available on your oscilloscope, you can set up the oscilloscope to optimize either **Analysis** (acquisition and calculation speed) or **Display** (update rate/speed) using the buttons provided on the **Optimize For** section of the dialog.

Available choices are presented as a spectrum with highest values at **Analysis** and **Display** extremes.

Select one of the buttons for the desired performance optimization.

Example reasoning for Analysis optimization would be its persistence or averaging usefulness. In such a case, giving higher priority to waveform acquisition at the expense of display update rate makes practical sense.

## Calibration

Access the Calibration preference settings by Selecting **Utilities** → **Calibration Setup ...** or touching the **Calibration** tab when in Preferences

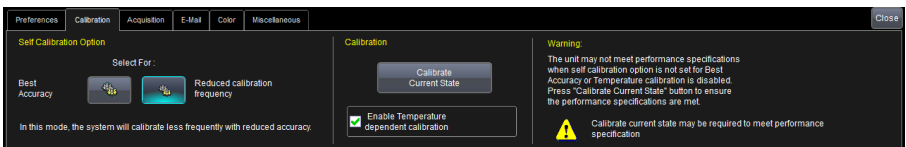
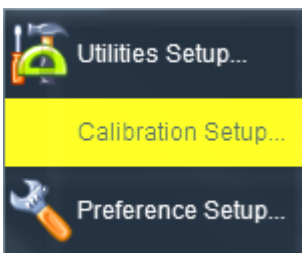

In the calibration dialog, the Self Calibration Option can be selected to be either **Best Accuracy** (default mode at shipment) or **Reduced Calibration Frequency**.

## WaveMaster 8 Zi/Zi-A Oscilloscopes

---

**Best Accuracy** will ensure that the oscilloscope always maintains the best possible accuracy at all all times and meets warranted specifications, even during wide temperature variations. It achieves this by constantly and internally sensing operating temperatures and performing small adjustments to meet warranted specifications regardless of internal or external temperature changes (provided that the oscilloscope is operated within its specified temperature range). This is a unique capability to LeCroy in that no user intervention is required to maintain warranted specifications.

**Reduced Calibration Frequency** automatically calibrates each unique oscilloscope setting (defined by V/div, time/div, sample rate, temperature, trigger source, etc.) and stores the calibration values in a non-volatile table that is saved during a power off state. These calibration values are recalled when that particular setting is returned to by the user. The table is of a finite length and settings are stored to it in a first-in first-out basis (FIFO), so the longer an oscilloscope is used with the same types of settings, the less it will calibrate when settings are changed. Note that if Reduce Calibration Frequency is selected, the warranted specifications of the unit are achieved only after the **Calibrate Current State** operation is performed. Note also that this method cannot be enabled if external clocking is being used.

The **Enable Temperature Dependent Calibration** capability will ensure, when checked, that the oscilloscope will re-calibrate if the internal temperatures change by more than  $\pm 3^{\circ}\text{C}$ . LeCroy recommends that this always be enabled.

If your oscilloscope did not ship with these capabilities enabled, it can be enabled with an upgrade to XStreamDSO Software vs. 6.9.0.3 and a return to a LeCroy Service Center for re-calibration.

## Acquisition

Access the **Acquisition** preference settings in the following manner:

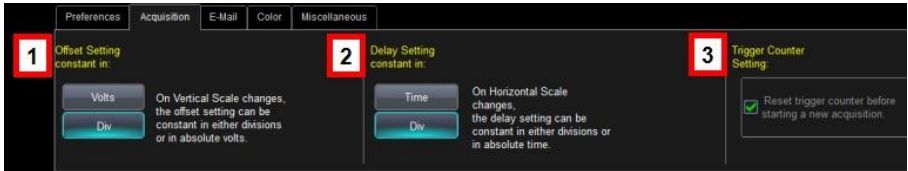

*The Acquisition dialog. Trigger Counter Setting is not available on all models.*

Numbers on the image correspond with the following explanations.

1. On the **Offset Setting constant in** area of the dialog, touch either the **Div** or **Volts** button.

As you change the gain, this control allows you to either keep the vertical offset level indicator stationary (when **Div** is selected) or to have it move with the actual voltage level (when **Volts** is selected). The advantage of selecting **Div** is that the waveform remains on the grid as you increase the gain; whereas, if **Volts** is selected, the waveform could move off the grid.

**Note:** Regardless of whether you select **Volts** or **Div**, the **Offset** shown in the channel setup dialog always indicates volts. However, when **Div** is selected for the Offset Control, the offset in volts is scaled proportional to the change in gain, thereby keeping the division on the grid constant.

2. On the **Delay Setting constant in** area of the dialog, touch either the **Time** or **Div** button.

As you change the timebase, this control allows you to either keep the horizontal offset indicator stationary (when **Div** is selected) or to have it move with the trigger point (when **Time** is selected). The advantage of selecting **Div** is that the trigger point remains on the grid as you increase the timebase; whereas, if **Time** is selected, the trigger point could move off the grid.

**Note:** Regardless of whether you select **Time** or **Div**, the **Delay** shown in the timebase setup dialog always indicates time. However, when **Div** is selected for Delay In, the delay in time is scaled proportional to the change in timebase, thereby keeping the division on the grid constant.

## WaveMaster 8 Zi/Zi-A Oscilloscopes

- If this checkbox control is available on your oscilloscope, you can mark the **Reset trigger counter before starting a new acquisition** checkbox on the **Trigger Counter Setting** area of the dialog. This preference clears the trigger counter each time the oscilloscope issues an arm acquisition command and applies when you have set a trigger Holdoff condition in the Trigger dialog in either time or events:

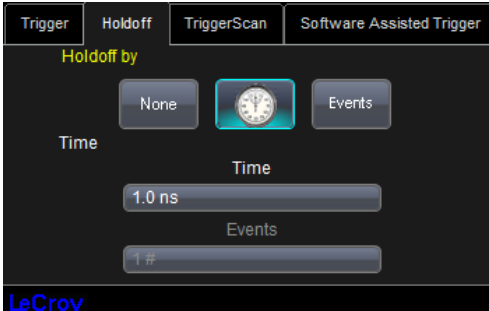

The default condition of this control is off (unchecked).

For each general category of oscilloscope operation, you can view a summary of your setups. Access these status dialogs by making the following menu bar selections:

- **Vertical** → **Channels Status**
- **Timebase** → **Acquisition Status**
- **Trigger** → **Acquisition Status**
- **Math** → **Math Status**, **Zoom Status**, or **Memory Status**

In addition to these dialogs, summaries are also provided for XY setups, memory (M1-M4) setups, and time stamps for sequence mode sampling.



## E-Mail

Configure this dialog to send email from the oscilloscope.

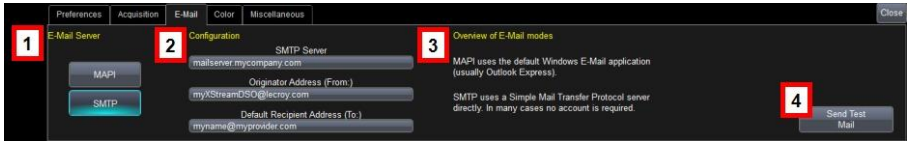

1. On the **E-Mail Server** section of the dialog, choose a server protocol from the following options:
  - **MAPI** (Messaging Application Programming Interface) is the Microsoft interface specification that allows different messaging and workgroup applications (including e-mail, voice mail, and fax) to work through a single client, such as the Exchange client. MAPI uses the default Windows e-mail application.
  - **SMTP** (Simple Mail Transfer Protocol) is a TCP/IP protocol for sending messages from one computer to another through a network. This protocol is used on the Internet to route e-mail. In many cases no account is needed.
2. Provide values for **SMTP Server**, **Originator Address (From:)**, and **Default Recipient Address (To:)** on the **Configuration** section of the dialog based the MAPI or SMTP choice during the previous step.
  - **If you chose MAPI**, touch inside the **Originator Address (From:)** data entry field and provide the instrument's e-mail address. Then touch inside the **Default Recipient Address (To:)** data entry field and provide the recipient's e-mail address.
  - **If you chose SMTP**, touch inside the **SMTP Server** data entry field and provide the name of your server. Touch inside the **Originator Address (From:)** data entry field and provide the instrument's e-mail address. Then touch inside the **Default Recipient Address (To:)** data entry field and provide the recipient's e-mail address.
3. The **Overview of E-Mail modes** section of the dialog provides helpful descriptions for your Server selection.
4. Use the **Send Test Mail** button to ensure proper E-Mail configuration by way of sending a confirmation message.

# WaveMaster 8 Zi/Zi-A Oscilloscopes

## Color

You can customize the Colors used for **Channels**, **Math**, and **Memory** traces both when shown on your instrument and when used in print output.

**Note:** These color settings match a waveform on the grid display (both on-screen and printed) and show consistently on corresponding **dialogs**, **tables**, and **trace descriptor labels**.



Numbered sections on this dialog correspond with the following explanations.

1. Make color selections for **Channels** (Screen and Print) by touching one of the color swatches. The Color pop-up control is shown and may be used to specify your desired color.
2. Just like Channels, make color selections for **Math Traces** (Screen and Print) by touching one of the color swatches. The Color pop-up control is shown and may be used to specify your desired color.
3. Again, just like Channels, make color selections for **Memory Traces** (Screen and Print) by touching one of the color swatches. The Color pop-up control is shown and may be used to specify your desired color.
4. You can use the **Factory default colors** button to instantly recall the original color settings for your instrument.

**Note:** Print colors are used only when the Colors is set to Print on the Hardcopy dialog. For convenience, the **Preview print colors** button is provided on this portion of the dialog. When the button is touched, a preview is generated on the grid display area. A subsequent touch of the button closes the preview.

## Miscellaneous

Other Preference setting controls are shown on the Miscellaneous dialog as follows:

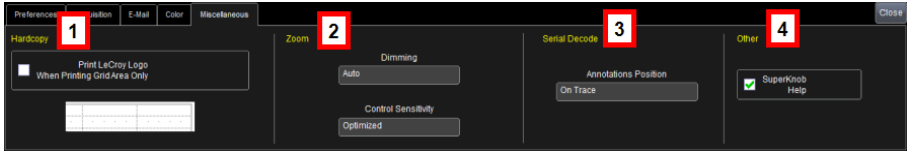

Numbers on this image correspond with the following explanations.

1. You can add the Teledyne LeCroy Logo to hardcopies of your grid display waveforms by marking the **Print Teledyne LeCroy Logo When Printing Grid Area Only** checkbox on the **Hardcopy** section of the dialog.
2. You can adjust the **Dimming** and **Control Sensitivity** of **Zoom** traces as follows:
  - Choose a **Dimming** of **On**, **Off**, and **Auto** values. This controls the darkening/shading of waveform areas not part of the Zoom trace.
  - Choose a **Control Sensitivity** of **Legacy** or **Optimized** values
3. If you have **Serial Data Debug Solutions** installed on your oscilloscope, you can control Annotations being put **On Trace** (on all traces) or **On Noisy Trace** (only on noisy traces).
4. You can shut off the SuperKnob Help flyout menu by un-marking the **SuperKnob Help** checkbox on the **Other** section of the dialog.

# System Recovery

## Restoring Software with Acronis True Image

Your oscilloscope is designed to operate reliably for many years. The application software operating the instrument runs on a Windows platform. The loading or incomplete removal of additional Windows applications can cause problems in the stability of the operating system. Severe cases may require a reloading of the base operating system and oscilloscope application. Teledyne LeCroy provides you with an Acronis® recovery application and a backup image in an extra partition on the instrument's hard drive.

### PLEASE NOTE THE FOLLOWING:

- The recovery process produces a replica of the operating system and oscilloscope application software at the current revision levels when the oscilloscope was manufactured. Any further revisions of the application software, Windows operating system, and virus scan definition files are not automatically upgraded. Therefore, after completion of the disk image recovery, it is highly recommended to search vendor Web sites and upgrade the individual components to current revision levels.
- After the recovery procedure is completed, you must activate Windows, either by Internet connection to Microsoft's Web site or by telephone. Have your Windows Product Key number (located on the rear of the oscilloscope) handy during Windows reactivation.
- The current oscilloscope application software can be downloaded directly from the Teledyne LeCroy website at [teledynelecroy.com](http://teledynelecroy.com). Since the calibration data for the oscilloscope is stored in the D: drive, current calibration constants are not overwritten during the recovery process.

Since third-party recovery software is used, our instructions certainly may not be the most definitive or current. We advise you to take advantage of resources available on the **Acronis** website - they maintain versions of their product manuals from the following locations:

### Acronis True Image® Home

<http://www.acronis.com/homecomputing/download/docs/>

### Acronis True Image Echo Workstation®

<http://www.acronis.com/backup-recovery/advanced-workstation/index.html>

**Note:** The following procedures cover basic steps for running the **True Image Echo Workstation**. For more definitive documentation refer to their aforementioned documentation resources.

Teledyne LeCroy provides you with a recovery application and a backup image in an extra partition on the instrument's hard drive. The recovery process is easy to perform, using the Recovery Wizard. After the recovery procedure is done, you must activate Windows, either by Internet connection to Microsoft's Web site or by telephone. Have your Windows Product Key number (shown on a sticker on your oscilloscope) handy during Windows reactivation.

### ***Running the Acronis True Image Echo Workstation Recovery Application***

1. Connect a network cable to the LAN port on the rear of the oscilloscope if you intend to activate windows through the Internet.
2. Connect a keyboard and a mouse to the oscilloscope.
3. Apply power to the oscilloscope.
4. As soon as the **Starting Acronis Loader... Press F11 for Acronis Startup Recovery Manager** message appears on the screen, press the **F11** key until the recovery software logo appears momentarily. The Acronis **True Image Echo Workstation** main window is displayed.

**Note:** Do not press **F11** before you see the **Starting Acronis Loader** message or you will enter the MB boot sequence selection.

5. Select **Recovery** from the **Main Menu**. The **Restore Data Wizard** opens.
6. Click **Next** on the **Welcome** page.
7. On the **Backup Archive Selection** page, you choose the zone where the recovery partition is located. Choose **Acronis Secure Zone** (this is

## WaveMaster 8 Zi/Zi-A Oscilloscopes

---

where the recovery data is located on your oscilloscope) and click **Next**.

8. On the **Backup Date Selection** page, choose the date when the backup was created and to which state you want to revert your system and click **Next**.
9. On the **Restoration Type Selection** page, select **Restore disks or partitions** and click **Next**.
10. On the **Partition or Disk to Restore** page, select **SYSTEM (C:)** as the source and click **Next**.
11. On the **Restored Partition Type** page, select **Active** and click **Next**.

**Note:** If a window appears asking if you want to buy Acronis products, click **Do not show this message again** and click **OK**.

12. The **Restored Partition Size** page displays the Partition size for the restoration. Nothing needs to be changed, simply click **Next**.
13. On the **Next Selection** page, you will be asked if you want to restore another partition or hard disk drive. Select **No, I do not** and click **Next**.
14. The **Restoration Options** page displays additional options, such as what to do after the restoration is complete and error handling. Simply click **Next** to use the default selections.
15. A summary window is displayed indicating that Acronis True Image is ready to proceed with the recovery of the C: partition. Click **Proceed** to start the recovery process.

**Note:** This takes approximately 4 to 15 minutes depending on the version of Operating system that is being restored. The progress is displayed on the screen

16. Once the restoration is complete, an Information window is displayed indicating that the **Data was successfully restored**. Click **OK**.
17. Click **Operations → Exit**. The oscilloscope will restart and begin installing the required software. A message is displayed asking if you want to install Microsoft Office PowerPoint Viewer.
18. Click **Yes** to install PowerPoint Viewer. The **InstallShield Wizard** for Adobe Flash Player opens.

19. To install Adobe Flash Player, click **Install** and then **Finish**. The X-Stream software installer screen appears.
20. Click **Next** to continue. The License Agreement page is displayed.
21. Click **I Agree**. The **Choose Components** page is displayed.
22. Select **all X-Stream components** and click **Install**.

**Note:** A Windows Security window may be displayed indicating that Windows can't verify the publisher of this driver software. Choose Install this driver software anyway and then click Install.

23. When the X-Stream installation is completed, reboot the oscilloscope.

**Note:** Now you must activate Windows® using an Internet connection to the Microsoft Web site or by telephone. When activating, have the Windows Product Key number handy (it is affixed to the rear of the oscilloscope).

### ***Restarting the Oscilloscope Application***

Upon initial power-up, the oscilloscope automatically loads the instrument application software. If you exit the application and want to reload it, touch the **shortcut icon** on the desktop:



**Note:** Maximize the application by touching the shortcut icon located on the lower-right of the screen.

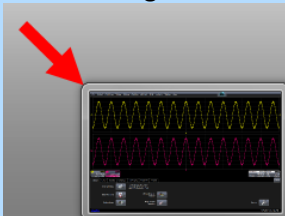

### ***Restarting the Operating System***

If you need to restart the Windows® operating system, reboot the oscilloscope by pressing and holding in the power switch for 10 seconds, then turning the power on again.

# Reference

## Specifications

Please refer to the Teledyne LeCroy website at [teledynelecroy.com](http://teledynelecroy.com) where detailed specification information is regularly maintained on corresponding product datasheets.

**Note:** Specifications are subject to change without notice.

## Certifications

This section certifies the instrument's Electromagnetic Compatibility (EMC), Safety and Environmental compliances.

### *EMC Compliance*

#### **EC DECLARATION OF CONFORMITY - EMC**

The oscilloscope meets intent of EC Directive 2004/108/EC for Electromagnetic Compatibility. Compliance was demonstrated to the following specifications as listed in the Official Journal of the European Communities:

EN 61326-1:2006, EN 61326-2-1:2006 EMC requirements for electrical equipment for measurement, control, and laboratory use. <sup>1</sup>

#### **Electromagnetic Emissions:**

CISPR 11:2003, Radiated and Conducted Emissions Group 1, Class A <sup>23</sup>

EN 61000-3-2:2006 Harmonic Current Emissions, Class A

EN 61000-3-3/A2:2005 Voltage Fluctuations and Flickers, Pst = 1

#### **Electromagnetic Immunity:**

EN 61000-4-2:2001 Electrostatic Discharge, 4 kV contact, 8 kV air, 4 kV vertical/horizontal coupling planes <sup>4</sup>

EN 61000-4-3:2006 RF Radiated Electromagnetic Field, 3 V/m, 80-1000 MHz; 3 V/m, 1400 MHz - 2 GHz; 1 V/m, 2 GHz - 2.7 GHz <sup>4</sup>

EN 61000-4-4:2004 Electrical Fast Transient/Burst, 1 kV on power supply lines, 0.5 kV on I/O signal data and control lines <sup>4</sup>

EN 61000-4-5:2006 Power line Surge, 1 kV AC Mains, L-N, L-PE, N-PE <sup>4</sup>



EN 61000-4-6:2007 RF Conducted Electromagnetic Field, 3 Vrms, 0.15 MHz - 80 MHz <sup>4</sup>

EN 61000-4-11:2004 Mains Dips and Interruptions, 0%/1 cycle, 70%/25 cycles, 0%/250 cycles <sup>4,5</sup>

1 To ensure compliance with all applicable EMC standards, high quality shielded interface cables should be used.

2 Emissions which exceed the levels required by this standard may occur when the oscilloscope is connected to a test object.

3 This product is intended for use in nonresidential areas only. Use in residential areas may cause electromagnetic interference.

4 Meets Performance Criteria “B” limits of the respective standard: during the disturbance, product undergoes a temporary degradation or loss of function or performance which is self-recoverable.

5 Performance Criteria “C” applied for 70%/25 cycle voltage dips and for 0%/250 cycle voltage interruption test levels per EN61000-4-11.

### **European Contact:**

Teledyne LeCroy Europe GmbH  
Waldhofer Str 104  
D-69123 Heidelberg  
Germany  
Tel: (49) 6221 82700

### **AUSTRALIA & NEW ZEALAND DECLARATION OF CONFORMITY – EMC**

Oscilloscope complies with the EMC provision of the Radio Communications Act per the following standards, in accordance with requirements imposed by Australian Communication and Media Authority (ACMA):

CISPR 11:2003 Radiated and Conducted Emissions, Group 1, Class A, in accordance with EN61326-1:2006 and EN61326-2-1:2006.

### **Australia / New Zealand Contacts:**

Vicom Australia Ltd.  
1064 Centre Road  
Oakleigh, South Victoria 3167  
Australia

Vicom New Zealand Ltd.  
60 Grafton Road  
Auckland  
New Zealand

## **Safety Compliance**

### **EC DECLARATION OF CONFORMITY – LOW VOLTAGE**

The oscilloscope meets intent of EC Directive 2006/95/EC for Product Safety. Compliance was demonstrated to the following specifications as listed in the Official Journal of the European Communities:

EN 61010-1:2010 Safety requirements for electrical equipment for measurement, control, and laboratory use – Part 1: General requirements

EN 61010-2:030:2010 Safety requirements for electrical equipment for measurement, control, and laboratory use – Part 2-030: Particular requirements for testing and measuring circuits

The design of the instrument has been verified to conform to the following limits put forth by these standards:

- Measurement Category II: equipment intended to be supplied from the building wiring with a nominal supply voltage up to 300V.
- Measurement Category 0: oscilloscope measurement terminals that are not intended to be directly connected to the MAINS supply.
- Pollution Degree 2: an operating environment where normally only dry, non-conductive pollution occurs. Occasionally a temporary conductivity that is caused by condensation must be expected. This location is a typical office/home environment.
- Protection Class I: grounded equipment in which protection against electric shock is achieved by Basic Insulation and a connection to the protective ground conductor in the building wiring.

### **U.S. NATIONALLY RECOGNIZED AGENCY CERTIFICATION**

The oscilloscope has been certified by Underwriters Laboratories (UL) to conform to the following safety standard and bears UL Listing Mark:

UL 61010-1 Second Edition – Safety standard for electrical measuring and test equipment.

### CANADIAN CERTIFICATION

The oscilloscope has been certified by Underwriters Laboratories (UL) to conform to the following safety standard and bears cUL Listing Mark:

CAN/CSA-C22.2 No. 61010-1-04. Safety requirements for electrical equipment for measurement, control and laboratory use.

### *Environmental Compliance*

#### END-OF-LIFE HANDLING

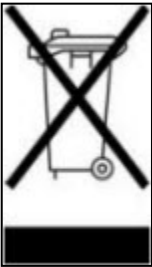

The instrument is marked with this symbol to indicate that it complies with the applicable European Union requirements to Directives 2002/96/EC and 2006/66/EC on Waste Electrical and Electronic Equipment (WEEE) and Batteries.

The instrument is subject to disposal and recycling regulations that vary by country and region. Many countries prohibit the disposal of waste electronic equipment in standard waste receptacles. For more information about proper disposal and recycling of your Teledyne LeCroy product, please visit [teledynelecroy.com/recycle](http://teledynelecroy.com/recycle).

#### RESTRICTION OF HAZARDOUS SUBSTANCES (ROHS)

This instrument has been classified as Industrial Monitoring and Control Equipment, and is outside the scope of the 2011/65/EU RoHS Directive until 22 July 2017 (per Article IV, Paragraph 3).

### *ISO Certification*

Manufactured under an ISO 9000 Registered Quality Management System. Visit [teledynelecroy.com](http://teledynelecroy.com) to view the certificate.

## Windows License Agreement

Teledyne LeCroy's agreement with Microsoft prohibits users from running software on Teledyne LeCroy X-Stream oscilloscopes that is not relevant to measuring, analyzing, or documenting waveforms.

# X-Stream Software End-User License Agreement

**IMPORTANT-READ CAREFULLY:** THIS END-USER LICENSE AGREEMENT ("EULA") IS A LEGAL AGREEMENT BETWEEN THE INDIVIDUAL OR ENTITY LICENSING THE SOFTWARE PRODUCT ("YOU" OR "YOUR") AND TELEDYNE LECROY CORPORATION ("TELEDYNE LECROY") FOR THE SOFTWARE PRODUCT(S) ACCOMPANYING THIS EULA, WHICH INCLUDE(S): COMPUTER PROGRAMS; ANY "ONLINE" OR ELECTRONIC DOCUMENTATION AND PRINTED MATERIALS PROVIDED BY TELEDYNE LECROY HEREWITH ("DOCUMENTATION"); ASSOCIATED MEDIA; AND ANY UPDATES (AS DEFINED BELOW) (COLLECTIVELY, THE "SOFTWARE PRODUCT"). BY USING AN INSTRUMENT TOGETHER WITH OR CONTAINING THE SOFTWARE PRODUCT, OR BY INSTALLING, COPYING, OR OTHERWISE USING THE SOFTWARE PRODUCT, IN WHOLE OR IN PART, YOU AGREE TO BE BOUND BY THE TERMS OF THIS EULA. IF YOU DO NOT AGREE TO THE TERMS OF THIS EULA, DO NOT INSTALL, COPY, OR OTHERWISE USE THE SOFTWARE PRODUCT; YOU MAY RETURN THE SOFTWARE PRODUCT TO YOUR PLACE OF PURCHASE FOR A FULL REFUND. IN ADDITION, BY INSTALLING, COPYING, OR OTHERWISE USING ANY MODIFICATIONS, ENHANCEMENTS, NEW VERSIONS, BUG FIXES, OR OTHER COMPONENTS OF THE SOFTWARE PRODUCT THAT TELEDYNE LECROY PROVIDES TO YOU SEPARATELY AS PART OF THE SOFTWARE PRODUCT ("UPDATES"), YOU AGREE TO BE BOUND BY ANY ADDITIONAL LICENSE TERMS THAT ACCOMPANY SUCH UPDATES. IF YOU DO NOT AGREE TO SUCH ADDITIONAL LICENSE TERMS, YOU MAY NOT INSTALL, COPY, OR OTHERWISE USE SUCH UPDATES.

**THE PARTIES CONFIRM THAT THIS AGREEMENT AND ALL RELATED DOCUMENTATION ARE AND WILL BE DRAFTED IN ENGLISH. LES PARTIES AUX PRÉSENTÉS CONFIRMENT LEUR VOLONTÉ QUE CETTE CONVENTION DE MÊME QUE TOUS LES DOCUMENTS Y COMPRIS TOUT AVIS QUI S'Y RATTACHÉ, SOIENT REDIGÉS EN LANGUE ANGLAISE.**

### 1. GRANT OF LICENSE.

1.1. **License Grant.** Subject to the terms and conditions of this EULA and payment of all applicable fees, Teledyne LeCroy grants to you a nonexclusive, nontransferable license (the "License") to: (a) operate the Software Product as provided or installed, in object code form, for your own internal business purposes, (i) for use in or with an instrument provided or manufactured by Teledyne LeCroy (an "Instrument"), (ii) for testing your software product(s) (to be used solely by you) that are designed to operate in conjunction with an

Instrument (“Your Software”), and (iii) make one copy for archival and back-up purposes; (b) make and use copies of the Documentation; provided that such copies will be used only in connection with your licensed use of the Software Product, and such copies may not be republished or distributed (either in hard copy or electronic form) to any third party; and (c) copy, modify, enhance and prepare derivative works (“Derivatives”) of the source code version of those portions of the Software Product set forth in and identified in the Documentation as “Samples” (“Sample Code”) for the sole purposes of designing, developing, and testing Your Software. If you are an entity, only one designated individual within your organization, as designated by you, may exercise the License; provided that additional individuals within your organization may assist with respect to reproducing and distributing Sample Code as permitted under Section 1.1(c)(ii). Teledyne LeCroy reserves all rights not expressly granted to you. No license is granted hereunder for any use other than that specified herein, and no license is granted for any use in combination or in connection with other products or services (other than Instruments and Your Software) without the express prior written consent of Teledyne LeCroy. The Software Product is licensed as a single product. Its component parts may not be separated for use by more than one user. This EULA does not grant you any rights in connection with any trademarks or service marks of Teledyne LeCroy. The Software Product is protected by copyright laws and international copyright treaties, as well as other intellectual property laws and treaties. The Software Product is licensed, not sold. The terms of this printed, paper EULA supersede the terms of any on-screen license agreement found within the Software Product.

**1.2. Upgrades.** If the Software Product is labeled as an "upgrade," (or other similar designation) the License will not take effect, and you will have no right to use or access the Software Product unless you are properly licensed to use a product identified by Teledyne LeCroy as being eligible for the upgrade ("Underlying Product"). A Software Product labeled as an "upgrade" replaces and/or supplements the Underlying Product. You may use the resulting upgraded product only in accordance with the terms of this EULA. If the Software Product is an upgrade of a component of a package of software programs that you licensed as a single product, the

## WaveMaster 8 Zi/Zi-A Oscilloscopes

---

Software Product may be used and transferred only as part of that single product package and may not be separated for use on more than one computer.

**1.3. Limitations.** Except as specifically permitted in this EULA, you will not directly or indirectly (a) use any Confidential Information to create any software or documentation that is similar to any of the Software Product or Documentation; (b) encumber, transfer, rent, lease, time-share or use the Software Product in any service bureau arrangement; (c) copy (except for archival purposes), distribute, manufacture, adapt, create derivative works of, translate, localize, port or otherwise modify the Software Product or the Documentation; (d) permit access to the Software Product by any party developing, marketing or planning to develop or market any product having functionality similar to or competitive with the Software Product; (e) publish benchmark results relating to the Software Product, nor disclose Software Product features, errors or bugs to third parties; or (f) permit any third party to engage in any of the acts proscribed in clauses (a) through (e). In jurisdictions in which transfer is permitted, notwithstanding the foregoing prohibition, transfers will only be effective if you transfer a copy of this EULA, as well as all copies of the Software Product, whereupon your right to use the Software product will terminate. Except as described in this Section 1.3, You are not permitted (i) to decompile, disassemble, reverse compile, reverse assemble, reverse translate or otherwise reverse engineer the Software Product, (ii) to use any similar means to discover the source code of the Software Product or to discover the trade secrets in the Software Product, or (iii) to otherwise circumvent any technological measure that controls access to the Software Product. You may reverse engineer or otherwise circumvent the technological measures protecting the Software Product for the sole purpose of identifying and analyzing those elements that are necessary to achieve Interoperability (the "Permitted Objective") only if: (A) doing so is necessary to achieve the Permitted Objective and it does not constitute infringement under Title 17 of the United States Code; (B) such circumvention is confined to those parts of the Software Product and to such acts as are necessary to achieve the Permitted Objective; (C) the information to be gained thereby has not already been made readily available to you or has not been provided by Teledyne LeCroy within

a reasonable time after a written request by you to Teledyne LeCroy to provide such information; (D) the information gained is not used for any purpose other than the Permitted Objective and is not disclosed to any other person except as may be necessary to achieve the Permitted Objective; and (E) the information obtained is not used (1) to create a computer program substantially similar in its expression to the Software Product including, but not limited to, expressions of the Software Product in other computer languages, or (2) for any other act restricted by Teledyne LeCroy's intellectual property rights in the Software Product. "Interoperability" will have the same meaning in this EULA as defined in the Digital Millennium Copyright Act, 17 U.S.C. §1201(f), the ability of computer programs to exchange information and of such programs mutually to use the information which has been exchanged.

1.4. **PRERELEASE CODE.** Portions of the Software Product may be identified as prerelease code ("Prerelease Code"). Prerelease Code is not at the level of performance and compatibility of the final, generally available product offering. The Prerelease Code may not operate correctly and may be substantially modified prior to first commercial shipment. Teledyne LeCroy is not obligated to make this or any later version of the Prerelease Code commercially available. The License with respect to the Prerelease Code terminates upon availability of a commercial release of the Prerelease Code from Teledyne LeCroy.

## 2. **SUPPORT SERVICES.**

At Teledyne LeCroy's sole discretion, from time to time, Teledyne LeCroy may provide Updates to the Software Product. Teledyne LeCroy shall have no obligation to revise or update the Software Product or to support any version of the Software Product. At Teledyne LeCroy's sole discretion, upon your request, Teledyne LeCroy may provide you with support services related to the Software Product ("Support Services") pursuant to the Teledyne LeCroy policies and programs described in the Documentation or otherwise then in effect, and such Support Services will be subject to Teledyne LeCroy's then-current fees therefor, if any. Any Update or other supplemental software code provided to you pursuant to the Support Services will be considered part of the Software Product and will be subject to the terms and conditions of this EULA. Teledyne LeCroy may use any technical information you provide to Teledyne

## WaveMaster 8 Zi/Zi-A Oscilloscopes

---

LeCroy during Teledyne LeCroy's provision of Support Services, for Teledyne LeCroy's business purposes, including for product support and development. Teledyne LeCroy will not utilize such technical information in a form that personally identifies you.

### 3. PROPRIETARY RIGHTS.

3.1. **Right and Title.** All right, title and interest in and to the Software Product and Documentation (including but not limited to any intellectual property or other proprietary rights, images, icons, photographs, text, and "applets" embodied in or incorporated into the Software Product, collectively, "Content"), and all Derivatives, and any copies thereof are owned by Teledyne LeCroy and/or its licensors or third-party suppliers, and is protected by applicable copyright or other intellectual property laws and treaties. You will not take any action inconsistent with such title and ownership. This EULA grants you no rights to use such Content outside of the proper exercise of the license granted hereunder, and Teledyne LeCroy will not be responsible or liable therefor.

3.2. **Intellectual Property Protection.** You may not alter or remove any printed or on-screen copyright, trade secret, proprietary or other legal notices contained on or in copies of the Software Product or Documentation.

3.3. **Confidentiality.** Except for the specific rights granted by this EULA, neither party shall use or disclose any Confidential Information (as defined below) of the other party without the written consent of the disclosing party. A party receiving Confidential Information from the other shall use the highest commercially reasonable degree of care to protect the Confidential Information, including ensuring that its employees and consultants with access to such Confidential Information have agreed in writing not to disclose the Confidential Information. You shall bear the responsibility for any breaches of confidentiality by your employees and consultants. Within ten (10) days after request of the disclosing party, and in the disclosing party's sole discretion, the receiving party shall either return to the disclosing party originals and copies of any Confidential Information and all information, records and materials developed therefrom by the receiving party, or destroy the same, other than such Confidential Information as to which this EULA expressly provides a continuing right to the receiving party to retain at the time of the request. Either party may only disclose the



general nature, but not the specific financial terms, of this EULA without the prior consent of the other party; provided either party may provide a copy of this EULA to any finance provider in conjunction with a financing transaction, if such provider agrees to keep this EULA confidential. Nothing herein shall prevent a receiving party from disclosing all or part of the Confidential Information as necessary pursuant to the lawful requirement of a governmental agency or when disclosure is required by operation of law; provided that prior to any such disclosure, the receiving party shall use reasonable efforts to (a) promptly notify the disclosing party in writing of such requirement to disclose, and (b) cooperate fully with the disclosing party in protecting against any such disclosure or obtaining a protective order. Money damages will not be an adequate remedy if this Section 4.3 is breached and, therefore, either party shall, in addition to any other legal or equitable remedies, be entitled to seek an injunction or similar equitable relief against such breach or threatened breach without the necessity of posting any bond. As used herein, "Confidential Information" means Teledyne LeCroy pricing or information concerning new Teledyne LeCroy products, trade secrets (including without limitation all internal header information contained in or created by the Software Product, all benchmark and performance test results and all Documentation) and other proprietary information of Teledyne LeCroy; and any business, marketing or technical information disclosed by Teledyne LeCroy, or its representatives, or you in relation to this EULA, and either (i) disclosed in writing and marked as confidential at the time of disclosure or (ii) disclosed in any other manner such that a reasonable person would understand the nature and confidentiality of the information. Confidential Information does not include information (A) already in the possession of the receiving party without an obligation of confidentiality to the disclosing party, (B) hereafter rightfully furnished to the receiving party by a third party without a breach of any separate nondisclosure obligation to the disclosing party, (C) publicly known without breach of this EULA, (d) furnished by the disclosing party to a third party without restriction on subsequent disclosure, or (e) independently developed by the receiving party without reference to or reliance on the Confidential Information.

#### 4. **TERMINATION.**

## WaveMaster 8 Zi/Zi-A Oscilloscopes

---

This EULA will remain in force until termination pursuant to the terms hereof. You may terminate this EULA at any time. This EULA will also terminate if you breach any of the terms or conditions of this EULA. You agree that if this EULA terminates for any reason, the License will immediately terminate and you will destroy all copies of the Software Product (and all Derivatives), installed or otherwise, the Documentation, and the Confidential Information (and all derivatives of any of the foregoing) that are in your possession or under your control. The provisions of Sections 1.3, 4, 6, 7, 8, and 9 will survive any termination or expiration hereof.

5. **U.S. GOVERNMENT RESTRICTED RIGHTS.**

If any Software Product or Documentation is acquired by or on behalf of a unit or agency of the United States Government (any such unit or agency, the "Government"), the Government agrees that the Software Product or Documentation is "commercial computer software" or "commercial computer software documentation" and that, absent a written agreement to the contrary, the Government's rights with respect to the Software Product or Documentation are, in the case of civilian agency use, Restricted Rights, as defined in FAR §52.227.19, and if for Department of Defense use, limited by the terms of this EULA, pursuant to DFARS §227.7202. The use of the Software Product or Documentation by the Government constitutes acknowledgment of Teledyne LeCroy's proprietary rights in the Software Product and Documentation. Manufacturer is Teledyne LeCroy Corporation, 700 Chestnut Ridge Road, Chestnut Ridge, NY 10977 USA.

6. **EXPORT RESTRICTIONS.**

You agree that you will not export or re-export the Software Product, any part thereof, or any process or service that is the direct product of the Software Product (the foregoing collectively referred to as the "Restricted Components"), to any country, person, entity or end user subject to U.S. export restrictions. You specifically agree not to export or re-export any of the Restricted Components (a) to any country to which the U.S. has embargoed or restricted the export of goods or services, which currently include, but are not necessarily limited to Cuba, Iran, Iraq, Libya, North Korea, Sudan and Syria, or to any national of any such country, wherever located, who intends to transmit or transport the Restricted Components back to such country; (b) to any end user who you know or have reason to

know will utilize the Restricted Components in the design, development or production of nuclear, chemical or biological weapons; or (c) to any end-user who has been prohibited from participating in U.S. export transactions by any federal agency of the U.S. government. You warrant and represent that neither the BXA nor any other U.S. federal agency has suspended, revoked or denied your export privileges. It is your responsibility to comply with the latest United States export regulations, and you will defend and indemnify Teledyne LeCroy from and against any damages, fines, penalties, assessments, liabilities, costs and expenses (including reasonable attorneys' fees and court costs) arising out of any claim that the Software Product, Documentation, or other information or materials provided by Teledyne LeCroy hereunder were exported or otherwise accessed, shipped or transported in violation of applicable laws and regulations.

### 7. **RISK ALLOCATION.**

**7.1. No Warranty.** THE SOFTWARE PRODUCT IS NOT ERROR-FREE AND THE SOFTWARE PRODUCT AND SUPPORT SERVICES IS/ARE BEING PROVIDED "AS IS" WITHOUT WARRANTY OF ANY KIND.

TELEDYNE LECROY, FOR ITSELF AND ITS SUPPLIERS, HEREBY DISCLAIMS ALL WARRANTIES, WHETHER EXPRESS OR IMPLIED, ORAL OR WRITTEN, WITH RESPECT TO THE SOFTWARE PRODUCT OR ANY SUPPORT SERVICES INCLUDING, WITHOUT LIMITATION, ALL IMPLIED WARRANTIES OF TITLE OR NON-INFRINGEMENT, MERCHANTABILITY, FITNESS FOR A PARTICULAR PURPOSE, ACCURACY, INTEGRATION, VALIDITY, EXCLUSIVITY, MERCHANTABILITY, NON-INTERFERENCE WITH ENJOYMENT, FITNESS FOR ANY PARTICULAR PURPOSE, AND ALL WARRANTIES IMPLIED FROM ANY COURSE OF DEALING OR USAGE OF TRADE. YOU ACKNOWLEDGE THAT NO WARRANTIES HAVE BEEN MADE TO YOU BY OR ON BEHALF OF TELEDYNE LECROY OR OTHERWISE FORM THE BASIS FOR THE BARGAIN BETWEEN THE PARTIES.

**7.2. Limitation of Liability.** TELEDYNE LECROY'S LIABILITY FOR DAMAGES FOR ANY CAUSE WHATSOEVER, REGARDLESS OF THE FORM OF ANY CLAIM OR ACTION, SHALL NOT EXCEED THE GREATER OF THE AMOUNT ACTUALLY PAID BY YOU FOR THE SOFTWARE PRODUCT OR U.S.\$5.00; PROVIDED THAT IF YOU HAVE ENTERED INTO A SUPPORT SERVICES AGREEMENT WITH TELEDYNE LECROY, TELEDYNE LECROY'S ENTIRE LIABILITY REGARDING SUPPORT

## WaveMaster 8 Zi/Zi-A Oscilloscopes

---

SERVICES WILL BE GOVERNED BY THE TERMS OF THAT AGREEMENT. TELEDYNE LECROY SHALL NOT BE LIABLE FOR ANY LOSS OF PROFITS, LOSS OF USE, LOSS OF DATA, INTERRUPTION OF BUSINESS, NOR FOR INDIRECT, SPECIAL, INCIDENTAL, CONSEQUENTIAL OR EXEMPLARY DAMAGES OF ANY KIND, WHETHER UNDER THIS EULA OR OTHERWISE ARISING IN ANY WAY IN CONNECTION WITH THE SOFTWARE PRODUCT, THE DOCUMENTATION OR THIS EULA. SOME JURISDICTIONS DO NOT ALLOW THE EXCLUSION OR LIMITATION OF INCIDENTAL OR CONSEQUENTIAL DAMAGES, SO THE ABOVE EXCLUSION OR LIMITATION MAY NOT APPLY TO YOU. THESE LIMITATIONS ARE INDEPENDENT FROM ALL OTHER PROVISIONS OF THIS EULA AND SHALL APPLY NOTWITHSTANDING THE FAILURE OF ANY REMEDY PROVIDED HEREIN.

7.3. **Indemnification.** You will defend, indemnify and hold harmless Teledyne LeCroy and its officers, directors, affiliates, contractors, agents, and employees from, against and in respect of any and all assessments, damages, deficiencies, judgments, losses, obligations and liabilities (including costs of collection and reasonable attorneys' fees, expert witness fees and expenses) imposed upon or suffered or incurred by them arising from or related to your use of the Software Product.

### 8. GENERAL PROVISIONS.

8.1. **Compliance with Laws.** You will comply with all laws, legislation, rules, regulations, and governmental requirements with respect to the Software Product, and the performance by you of your obligations hereunder, of any jurisdiction in or from which you directly or indirectly cause the Software Product to be used or accessed.

8.2. **No Agency.** Nothing contained in this EULA will be deemed to constitute either party as the agent or representative of the other party, or both parties as joint venturers or partners for any purpose.

8.3. **Entire Agreement; Waiver; Severability.** This EULA constitutes the entire agreement between the parties with regard to the subject matter hereof. No provision of, right, power or privilege under this EULA will be deemed to have been waived by any act, delay, omission or acquiescence by Teledyne LeCroy, its agents, or employees, but only by an instrument in writing signed by an authorized officer of Teledyne LeCroy. No waiver by Teledyne LeCroy of any breach or default of any provision of this EULA by you

will be effective as to any other breach or default, whether of the same or any other provision and whether occurring prior to, concurrent with, or subsequent to the date of such waiver. If any provision of this EULA is declared by a court of competent jurisdiction to be invalid, illegal or unenforceable, such provision will be severed from this EULA and all the other provisions will remain in full force and effect.

**8.4. Governing Law; Jurisdiction; Venue.** This EULA will be governed by and construed in accordance with the laws of the State of New York, USA, without regard to its choice of law provisions. The United Nations Convention on Contracts for the International Sale of Goods will not apply to this EULA. Exclusive jurisdiction and venue for any litigation arising under this EULA is in the federal and state courts located in New York, New York, USA and both parties hereby consent to such jurisdiction and venue for this purpose.

**8.5. Assignment.** This EULA and the rights and obligations hereunder, may not be assigned, in whole or in part by you, except to a successor to the whole of your business, without the prior written consent of Teledyne LeCroy. In the case of any permitted assignment or transfer of or under this EULA, this EULA or the relevant provisions will be binding upon, and inure to the benefit of, the successors, executors, heirs, representatives, administrators and assigns of the parties hereto.

**8.6. Notices.** All notices or other communications between Teledyne LeCroy and you under this EULA will be in writing and delivered personally, sent by confirmed fax, by confirmed e-mail, by certified mail, postage prepaid and return receipt requested, or by a nationally recognized express delivery service. All notices will be in English and will be effective upon receipt.

**8.7. Headings.** The headings used in this EULA are intended for convenience only and will not be deemed to supersede or modify any provisions.

**8.8. Acknowledgment.** Licensee acknowledges that (a) it has read and understands this EULA, (b) it has had an opportunity to have its legal counsel review this EULA, (c) this EULA has the same force and effect as a signed agreement, and (d) issuance of this EULA does not constitute general publication of the Software Product or other Confidential Information.

## Contact Teledyne LeCroy

### Teledyne LeCroy Service Centers

|   |   |
|---|---|
| <p><b>United States and Canada -<br/>World Wide Corporate Office</b><br/>Teledyne LeCroy Corporation<br/>700 Chestnut Ridge Road<br/>Chestnut Ridge, NY, 10977-6499, USA<br/>Ph: 800-553-2769 / 845-425-2000<br/>FAX: 845-578-5985<br/>teledynelecroy.com<br/><b>Support:</b><br/>contact.corp@teledynelecroy.com<br/><b>Sales:</b><br/>customersupport@teledynelecroy.com</p>          | <p><b>United States - Protocol Solutions Group</b><br/>Teledyne LeCroy Corporation<br/>3385 Scott Boulevard<br/>Santa Clara, CA, 95054, USA<br/>FAX: 408-727-0800<br/>teledynelecroy.com<br/><b>Sales and Service:</b><br/>Ph: 800-909-7211 / 408-727-6600<br/>contact.corp@teledynelecroy.com<br/><b>Support:</b><br/>Ph: 800-909-7112 / 408-653-1260<br/>psgsupport@teledynelecroy.com</p>            |
| <p><b>European Headquarters</b><br/>Teledyne LeCroy SA<br/>4, Rue Moïse Marcinhes<br/>Case postale 341<br/>1217 Meyrin 1<br/>Geneva, Switzerland<br/>Ph: + 41 22 719 2228 / 2323 /2277<br/>FAX:+41 22 719 2233<br/>contact.sa@teledynelecroy.com<br/>applications.indirect@teledynelecroy.com<br/>teledynelecroy.com/europe<br/><b>Protocol Analyzers:</b><br/>Ph: +44 12 765 03971</p> | <p><b>Singapore, Oscilloscopes</b><br/>Teledyne LeCroy Singapore Pte Ltd.<br/>Blk 750C Chai Chee Road #02-08<br/>Technopark @ Chai Chee<br/>Singapore 469003<br/>Ph: ++ 65 64424880<br/>FAX: ++ 65 64427811<br/><b>Singapore, Protocol Analyzers</b><br/>Genetron Singapore Pte Ltd.<br/>37 Kallang Pudding Road, #08-08<br/>Tong Lee Building Block B<br/>Singapore 349315<br/>Ph: ++ 65 9760-4682</p> |
| <p><b>China</b><br/>Teledyne LeCroy Corporation Beijing<br/>Rm. 2001<br/>Unit A, Horizon Plaza<br/>No. 6, Zhichun Road, Haidian District<br/>Beijing 100088, China<br/>Ph: ++86 10 8280 0318 / 0319 / 0320<br/>FAX:++86 10 8280 0316<br/><b>Service:</b><br/>Rm. 2002<br/>Ph: ++86 10 8280 0245</p>   | <p><b>Korea</b><br/>Teledyne LeCroy Korea<br/>10th fl.Ildong Bldg.<br/>968-5 Daechi-dong, Gangnam-gu<br/>Seoul 135-280, Korea<br/>Ph: ++ 82 2 3452 0400<br/>FAX: ++ 82 2 3452 0490</p>  |
| <p><b>Taiwan</b><br/>LeColn Technology Co Ltd.<br/>Far East Century Park, C3, 9F<br/>No. 2, Chien-8th Road,<br/>Chung-Ho Dist., New Taipei City, Taiwan<br/>Ph: ++ 886 2 8226 1366<br/>FAX: ++ 886 2 8226 1368</p>  | <p><b>Japan</b><br/>Teledyne LeCroy Japan<br/>Hobunnya Funchu Bldg, 3F<br/>3-11-5, Midori-cho, Fuchu-Shi<br/>Tokyo 183-0006, Japan<br/>Ph: ++ 81 4 2402 9400<br/>FAX: ++ 81 4 2402 9586<br/>teledynelecroy.com/japan</p>  |

# Index

## 2

2.92 mm and 2.4 mm Probe and Cable Connection Interface, 24

## A

**Acquisition**, 165

actions, 123

Actions for Trace Buttons, 35, 42

Actions for Trace C1 Buttons, 63

active probe, 26

Annotating Traces, 35

autogrid, 86

Aux Output, 157

Auxiliary Output Signals, 158

axis labels, 87

## C

Calibration Output Signals, 159

Channel Controls, 60

clipboard, 154

Color, 168

Combining, 45

Condition-Based Right-Hand Dialogs, 120

Connecting the Adapters, 27

Coupling, 75

Create a Folder, 162

Cursor Types, 97

922133-00 Rev A

cursors

setup, 98

Cursors, 100

customization

connectivity, 136

Customization Overview, 136

## D

data formats, 145

Date/Time, 159

DBI, 46

Default Recipient Address (To, 167

Delete a single file, 161

Delete all files in a folder, 161

deleting files, 161

Dialog Area, 37

disk utilities, 161

Displaying an Individual Segment, 56

Displays Containing Masks, 89

Dual Display Grid Selection, 89

## E

E-Mail, 167

## F

file name numbering, 145

files: deleting, 161

# WaveMaster 8 Zi/Zi-A Oscilloscopes

---

Find Scale, 63

**L**

Flashback (Recall), 139

Front Panel Controls, 14

LabNotebook

drawing toolbar, 138

LabNotebook Overview, 137

LeCroy External Display (Zi-EXTDISP-15) Setup, 11

Level, 77

Linear, 65

**G**

grid intensity, 87

grid on top, 87

**H**

hardcopy setup, 153

Help, 106

help markers, 105

histicons, 114

histograms

creating and viewing, 110

histicons, 114

persistence, 114

slice center, 114

thumbnail, 114

holdoff, 78

Horizontal Front Panel Controls,  
17

**I**

Intensity knob, 92

intensity of grid, 87

intensity of trace, 88

inverting waveforms, 64

**M**

Mask Testing, 129

math setup, 127

Math Traces and Functions  
Overview, 126

measure modes, 104

Measurement Parameter  
Analysis Overview, 108

Measurement Parameters  
Overview, 101

Measuring with Cursors  
Overview, 97

Menu Bar, 30

Message Bar, 43

Miscellaneous, 169

Miscellaneous Setup Controls  
and WaveStream Indicator, 15

moving traces, 88

**O**

operating system: restarting, 173

Optimize, 78



Originator Address (From, 167  
Overview of E-Mail modes, 167

### P

Parameter Measurements, 135  
parameter setup, 102  
parameters  
    measure modes, 104  
    standard vertical, 104  
Pass/Fail Condition Setup, 119  
Pass/Fail Parameter Testing  
Overview, 118  
pass/fail testing  
    actions, 123  
Pass/Fail Testing Setup, 124  
Passive Probe Compensation, 29  
performance optimization, 163  
Persistence Histogram, 114  
Persistence Setup, 90  
Preference Setup Overview, 162  
Preferences, 162  
Pre-Processing Controls, 64  
Probe and Signal Connection  
Interfaces Overview, 20  
Probes, 28  
ProLink Interface Adapters, 25  
ProLink Probe Adapters, 27  
ProLink Probe Interface, 24

### Q

Quick, 101  
922133-00 Rev A

Quick Access to Pass/Fail Setup  
Dialogs, 130  
Quickly Displaying Cursors, 98

### R

recalling default scope settings,  
144  
Recalling Setup(s) Directly from a  
File, 144  
Recalling Setup(s) Internally on  
Your Instrument, 143  
Recalling Waveforms, 147  
remote: configuring, 151  
Removing a Mask from the  
Display, 131  
Response, 65  
Restoring Software Usng the  
Acronis Application, 170  
RIS mode, 58  
roll mode, 59

### S

Sampling Mode, 135  
sampling modes, 50  
Save/Recall Overview, 142  
Saving and Recalling Setups, 143  
Saving and Recalling  
Waveforms, 144  
Saving Oscilloscope Setup(s), 143  
Saving Setup(s) Directly to a File,  
143

# WaveMaster 8 Zi/Zi-A Oscilloscopes

---

Saving Setup(s) Internally on Your Instrument, 143

Saving TriggerScan Setups, 84

Saving Waveforms, 144

Screen Layout, Groupings, and Controls, 30

Search Modes, 134

segments

- displaying, 56

Send Test Mail, 168

Sequence Display Modes, 52

sequence mode display setup, 88

Sequence Sampling Mode – Working with Segments, 51

sequence sampling mode

- display modes, 56

- timeouts, 54

Setting Up Sequence Mode, 53

Setup, 75

Signal Display Grid Pop-Up Menu, 33

Signal Views, 134

Single Parameter Histogram Setup, 110

Single Parameter Histogram Setup Using Math, 112

Single Parameter Histogram Setup Using Measure, 110

single-shot sampling mode, 50

slice center, 114

Slope, 76

SMTP Server, 167

SNTP, 159

Source, 75

Specifications, 174

Starting TriggerScan, 83

status of scope, 150

## T

technical support, 177

Testing and Enabling Pass/Fail Conditions, 118

The Back of Your Oscilloscope, 10

The Cursors Dialog, 98

The Front of Your Oscilloscope, 6

The I/O Panel, 9

The Quick Access Toolbar, 31

The Signal Display Grid, 31

thumbnail histograms, 114

time stamps, 57

Timebase Setup and Control, 45

Trace Descriptor Labels, 33

trace intensity, 88

track and trend differences, 108

track views, 116

Training TriggerScan, 82

trend: creating and viewing, 115

Trigger, 75

trigger counter, 166

trigger coupling, 76

Trigger Front Panel Controls, 16

Trigger Overview, 68

trigger setup

coupling, 76  
holdoff, 78  
trigger types, 69  
trigger types, 69

TriggerScan, 81

Turning, 101

Turning on Channels and Traces,  
44

Type, 75

## U

utilities

audio feedback, 162  
autocalibration, 163  
auxiliary output signals, 158  
clipboard, 154  
delay control, 165  
delay in, 165  
email, 155  
file, 155  
hardcopy, 153  
offset control, 165  
options, 160  
performance optimization, 163  
remote: configuring, 151  
SNTP, 159  
status, 150  
trigger counter, 166

Utilities Dialog, 149

Utilities Overview, 149

## V

Vertical Front Panel Controls, 18  
view aux in, 80

## W

WaveML data format, 146

WaveScan Overview, 133

WaveStream, 92

Width, 78

Windows operating system, 173

## Z

Zoom, 63

Zoom and Math Front Panel  
Controls, 19

Zooming Segments in Sequence  
Mode, 55

Zooming Waveforms Overview,  
93







**TELEDYNE LECROY**  
Everywhereyoulook™

700 Chestnut Ridge Road  
Chestnut Ridge, NY 10977  
USA

[teledynelecroy.com](http://teledynelecroy.com)