

Lab manual: Free-space quantum key distribution simulated

(Dated: November 1, 2020)

I. OBJECTIVES AND WORKFLOW

In this lab exercise you will assemble and use an optical setup that simulates Bennett-Brassard 1984 (BB84) quantum key distribution protocol with polarized photons. The only “fake” or simulated aspect of this setup is that single-photon detectors have been replaced with classical photodiodes and a microcontroller. The microcontroller simulates detection outcomes based on the amount of light received by the two photodiodes. This allows you to “execute” the BB84 protocol manually, slowly, using a bright laser beam in a lit room and recording the detection outcomes with a pen and paper. The protocol is otherwise simulated correctly, as you will hopefully see.

You will also learn how to assemble a free-space optical setup out of standard components. The setup is given to you as a collection of parts, and you should fully disassemble it and put back into the storage boxes after you are done.

The setup and program of the experiment are fully described in the enclosed Thorlabs manual. Chapters 7–9 contain all the exercises you should do.

For generating random bit values during the exercises, may we suggest that you flip coins or roll a dice. This will produce almost unbiased random bits.

Please avoid touching polished glass surfaces of optical components with your fingers and avoid placing the polished surfaces in contact with the desk. The optical components (prisms and half-wave plates) should be held in your fingers by their edges and matte sides. The glass components are wrapped in lens paper for storage, to protect them from scratches. When you are disassembling the setup, inspect the optical surfaces of each component for fingerprints before you wrap it in lens paper and put it into its storage box. If a fingerprint is found, please ask the lab assistant to clean it. Leaving the fingerprint on the component may damage it over time, as body oil slowly reacts with the optical coatings and glass.

Also, do not look directly into the laser beam. While the laser used in this setup is low-power, it’s always a bad idea to put your eye into the beam.

Your lab report will consist of your work sheets that Alice, Bob, and Eve fill in during the exercises (you may use ‘measuring protocols’ from the manual or make your own sheets). You have to assemble the entire setup and complete all twelve exercises. Please also calculate the quantum bit error rate in the last exercise and compare it with the theoretically expected error rate.

THORLABS

Discovery

EDU-QCRY1
EDU-QCRY1/M
Quantum Cryptography
Demonstration Kit

Manual

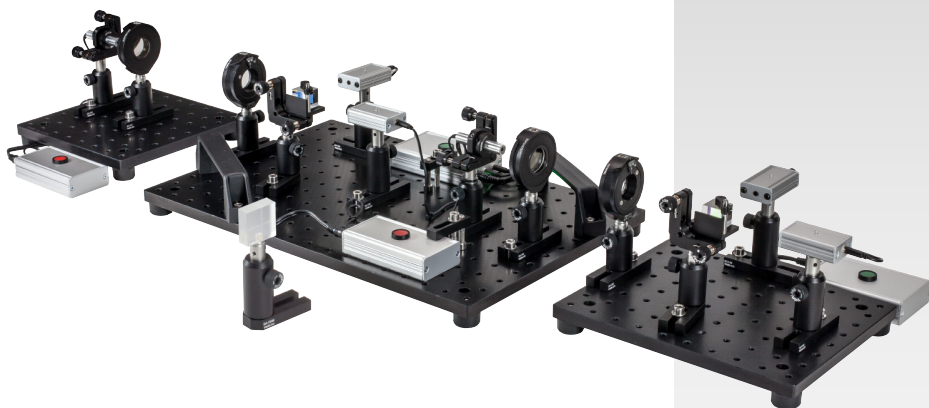

Table of Contents















Chapter 1	Warning Symbol Definitions.....	1
Chapter 2	Safety	2
Chapter 3	Brief Description	3
Chapter 4	Components and Parts List	5
Chapter 5	Fundamentals of Quantum Cryptography	9
	5.1. Introduction.....	9
	5.2. The One-Time Pad.....	9
	5.3. Key Distribution	11
	5.3.1. $\lambda/2$ Plate and Data Transmission with One Basis	11
	5.3.2. Key Distribution – The Right Way	13
	5.4. Detection of an Eavesdropper	15
	5.5. What Does “Random” Mean?	17
	5.6. What prevents one from simply copying the information?	17
	5.7. Experimental Procedure	18
	5.8. Classical Light Versus Single Photons	19
	5.9. Mathematical Description in Dirac-Notation.....	19
Chapter 6	Examples	25
	6.1. Encryption Protocol without Eve (Two Letters).....	25
	6.2. Encryption Protocol with Eve.....	27
Chapter 7	Setup and Adjustment.....	30
	7.1. Component Assembly	30
	7.2. Electronics	32
	7.2.1. Power Supply	32
	7.2.2. Laser Electronics.....	32
	7.2.3. Sensor Electronics	33
	7.3. Adjusting the Laser and $\lambda/2$-Plates.....	33
	7.4. Setup for Alice and Bob.....	36

7.5. Adding Eve	38
Chapter 8 Experiment	39
8.1. Key Generation	39
8.2. Encryption and Transmission of a Four-Letter Word	40
8.3. Adding Eve and Detection of Eavesdropping	40
Chapter 9 Measuring Protocols	42
Chapter 10 Teaching Tips	46
Chapter 11 Troubleshooting	47
Chapter 12 Acknowledgements	48
Chapter 13 Regulatory	49
13.1. Waste Treatment is Your Own Responsibility	49
13.2. Ecological Background	49
Chapter 14 Thorlabs Worldwide Contacts	50



Chapter 1 Warning Symbol Definitions

Below is a list of warning symbols you may encounter in this manual or on your device.

Symbol	Description
	Direct Current
	Alternating Current
	Both Direct and Alternating Current
	Earth Ground Terminal
	Protective Conductor Terminal
	Frame or Chassis Terminal
	Equipotentiality
	On (Supply)
	Off (Supply)
	In Position of a Bi-Stable Push Control
	Out Position of a Bi-Stable Push Control
	Caution: Risk of Electric Shock
	Caution: Hot Surface
	Caution: Risk of Danger
	Warning: Laser Radiation

Chapter 2 Safety



WARNING



The laser module is a class 2 laser. Although no protective eyewear is required around class 2 lasers, you should not look directly into the beam or into scattered light.



ATTENTION



To avoid contamination and damage, never touch the $\lambda/2$ plates with bare fingers. Wear protective gloves.

Chapter 3 Brief Description

Cryptography, the encryption of messages and data, has always been a fundamental topic in the field of communication. A wide variety of different methods were developed over the centuries in order to prevent decryption by third parties. However, all encryption methods have weaknesses; no method is considered entirely secure. Encryption methods using quantum physics have been proposed which can guarantee safety from interception. This kit discusses the BB84 protocol which combines the one-time pad encryption method with the quantum key distribution method.

The one-time pad method uses a random binary sequence of 0s and 1s that constitutes a perfect data transmission key. Adding this key to the intended binary message makes the encrypted message a random sequence of 0s and 1s as well. Using the key to decode the encrypted message returns the original message prior to decryption. Only if the sender (“Alice”) and the recipient (“Bob”) know the key can the encrypted message be securely transmitted publicly. Interception is meaningless without the missing key, since there is no methodology or pattern underlying the key.

The fundamental challenge of this encryption method is ensuring that only Alice and Bob have knowledge of the encryption key. The BB84 encryption protocol was developed solely for this purpose. This protocol describes how an encryption key known only to Alice and Bob can be generated. One major advantage of this method is that the BB84 protocol inherently enables the detection of an interception attack by a third party, referred to as “Eve” (for eavesdropping).

The BB84 protocol functions by defining two bases that each include two polarizations of light: the + basis consists of 0° and 90° polarizations and the x basis consists of -45° and 45° polarizations. In this scheme, either basis can be used to represent a binary 0 (0° or -45°) and a binary 1 (90° or 45°). Alice sends a random bit in a random basis and Bob measures in a random basis. Then they exchange the basis via a public channel. If they each used a different basis, the measurement is discarded; if the basis is the same, both have now generated a key bit. Since the public exchange only contains the basis, the bit is unknown to others. If Eve attempts to intervene between Alice and Bob, she too can only guess the basis for each bit. Because the basis guess is random, the wrong basis will be chosen in 50% of all cases, which automatically results in errors that Alice and Bob can detect by exchanging a few test bits.

The quantum physics aspect of this protocol relies on using a single photon light source to carry the information, such that a single information bit is carried by only one photon in a specific state and therefore cannot be copied. Quantum optic processes can also be used to generate random numbers. Because quantum physics plays a role “only” for key generation, the term “quantum cryptography” is less commonly used than “quantum key distribution (QKD)”.

This educational experiment simulates the key principles used in quantum cryptography. An interception attack is also carried out, with a demonstration that it can be detected. Initially the experiment starts with Alice and Bob, who choose random bases and then generate a secret key by comparing the bases. Alice encodes and sends the message, Bob receives and decodes it. Then Eve is added to the setup and the experiment is

repeated. Alice sends a bit, Eve tries to intercept it, and then Eve sends the bit to Bob in the basis that she had chosen for her measurement. At the end of the experiment, Alice and Bob compare their bases via a public exchange and also a few test bits. If they find that approximately 25% of the test bits are now incorrect (caused by errors in the bits sent by Eve), they will know that an eavesdropper is present.

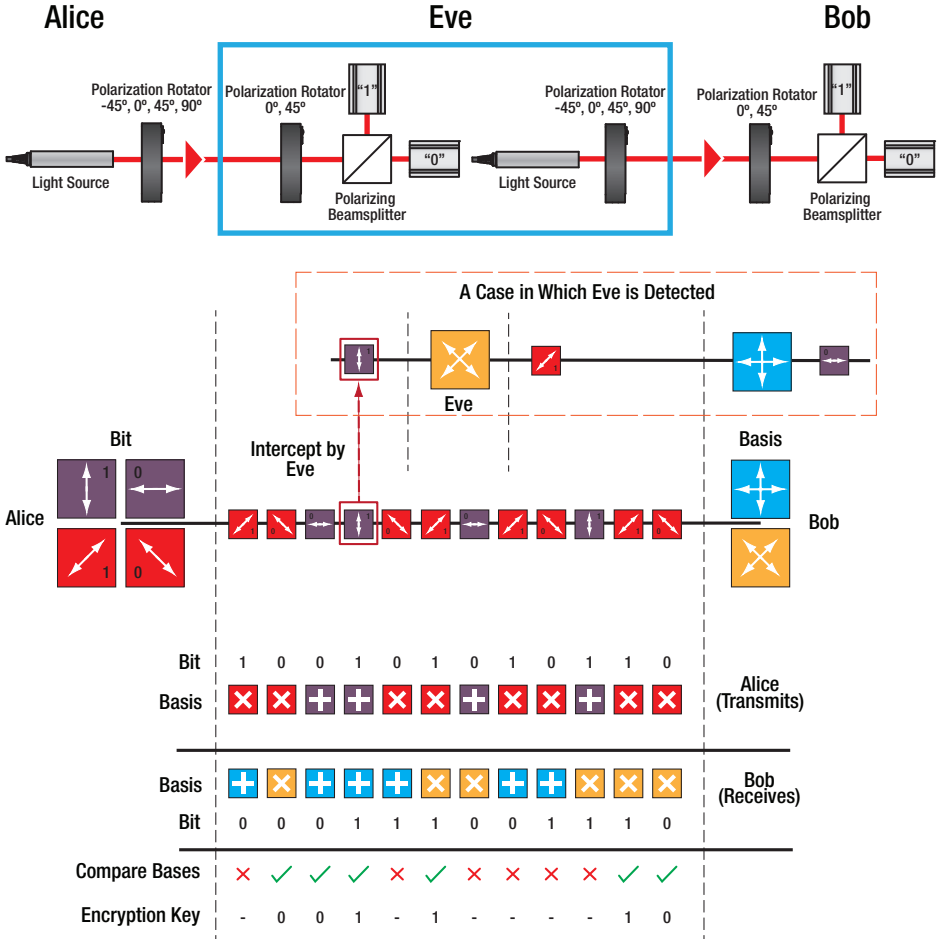

Figure 1 Overview of Quantum Cryptography Setup and Experiment

Instead of individual photons, this experiment works with a pulsed laser. Accordingly all results can be described purely through classical physics. A quantum physics setup works with individual photons, but its functioning is completely identical. Therefore this setup is very well suited for an analogous experiment.

Chapter 4 Components and Parts List

In cases where the metric and imperial kits contain parts with different item numbers, metric part numbers and measurements are indicated by parentheses unless otherwise noted.

 <p>1 x MB8 (MB2020/M) Aluminum Breadboard 8" x 8" (20 cm x 20 cm)</p>	 <p>1 x MB810 (MB2025/M) Aluminum Breadboard 8" x 10" (20 cm x 25 cm)</p>	 <p>1 x MB1218 (MB3045/M) Aluminum Breadboard 12" x 18" (30 cm x 45 cm)</p>
 <p>3 x RDF1 Rubber Damping Feet (4 Pack)</p>	 <p>10 x BA1(/M) Base, 1" x 3" x 3/8" (25 mm x 75 mm x 10 mm)</p>	 <p>5 x PH2 (PH50/M) Ø1/2" (Ø12.7 mm) Post Holder, 2" (50 mm) Long</p>
 <p>6 x PH1.5 (PH40/M) Ø1/2" (Ø12.7 mm) Post Holder, 1.5" (40 mm) Long</p>	 <p>2 x UPH2 (UPH50/M) Ø1/2" (Ø12.7 mm) Universal Post Holder, 2" (50 mm) Long</p>	 <p>Imperial: 6 x TR1.5 Metric: 4 x TR30/M, 2 x TR40/M Ø1/2" (Ø12.7 mm) Posts, 1.5" (30 mm, 40mm) Long</p>

 <p>7 x TR2 (TR50/M) Ø1/2" (Ø12.7 mm) Post, 2" (50 mm) Long</p>	 <p>2 x RSP1X225(/M)-ALICE Ø1" Indexing Rotation Mount, 22.5° steps</p>	 <p>2 x RSP1X225(/M)-BOB Ø1" Indexing Rotation Mount, 22.5° Steps</p>
 <p>4 x WPH10E-633 λ/2 Plate, Zero Order</p>	 <p>2 x Kinematic Mount Modified KM100PM(/M)</p>	 <p>2 x PM3(/M) Clamping Arm</p>
 <p>2 x PBS201 Polarizing Beamplitter Cube, 20 mm x 20 mm</p>	 <p>2 x KM100 Kinematic Mount, Ø1"</p>	 <p>2 x AD11NT Ø1" Adapter for Ø11 mm Components</p>

 <p>2 x CPS635R-C2 635 nm Laser Diode Module, Class 2</p>	 <p>1 x BA1S(/M) Base, 1" x 2.3" x 3/8" (25 mm x 58 mm x 10 mm)</p>	 <p>1 x AT1(/M) Alignment Tool 1.18" x 1.18" (30.0 mm x 30.0 mm)</p>
 <p>2 x CL3/M Clamp</p>	 <p>1 x BBH1 Breadboard Handles</p>	 <p>1 x SPW606 SM1 Spanner Wrench, Length = 1"</p>
 <p>4 x Sensor</p>	 <p>2 x Sensor Electronics</p>	 <p>2 x Laser Electronics</p>

Imperial Kit Screws, Ball Driver, and Hex Keys

Type	Quantity	Type	Quantity
1/4"-20 x 3/8" Cap Screw	11	1/4" Washer	19
1/4"-20 x 1/2" Cap Screw	12	 <p>1 x BD-3/16L Balldriver for 1/4"-20 Screws</p>	
1/4"-20 x 5/8" Cap Screw	17		
1/4"-20 x 1.25" Cap Screw	2		
1/4"-20 x 2" Cap Screw	2		
Hex Keys: 1/8", 3/32" and 1/16"			
4 x AS4M8E: Thread Adapter (Internal M4 x 0.7, External 8-32 Threaded Stud)			

Metric Kit Screws, Ball Driver, and Hex Keys

Type	Quantity	Type	Quantity
M6 x 10 mm Cap Screw	11	M6 Washer	19
M6 x 12 mm Cap Screw	12	 <p>1 x BD-5ML Balldriver for M6 Screws</p>	
M6 x 16 mm Cap Screw	17		
M6 x 30 mm Cap Screw	2		
M6 x 45 mm Cap Screw	2		
Hex Keys: 3 mm, 2 mm and 1.5 mm			

Chapter 5 Fundamentals of Quantum Cryptography

This section explains how quantum cryptography works and the steps required to carry it out. It starts with a brief introduction and then explains the one-time pad which turns a message and a key into an encrypted message. This is followed by the generation of the keys, constituting the essential element of quantum cryptography.

The value of quantum cryptography lies in the safety from interception. Section 5.4 discusses how an eavesdropper can be detected using this method.

5.1. Introduction

Cryptography describes the encryption of data: that is, rendering a message unrecognizable, ideally making it readable only for the sender and the recipient. This means that the encrypted message is only meaningful if the key to decode it is known. The security of the key is based either on complex underlying algorithms or on practical constraints such as the factorization of large numbers.

All classical cryptography methods have the disadvantage that one can never be sure that the key will not be "cracked" eventually. This fundamental problem however can be solved with the use of quantum physics. One of the core rules governing quantum physics is that observing the state of a photon or particle simultaneously causes the state to change. This principle, along with true random number generation, is what allows a user to generate a *random* key that is *known only to the sender and the recipient*. As an added feature, any attempt at interception can theoretically be identified.

There already exist some examples of encryption systems that employ quantum cryptography. These systems are commercially available today, for example at <http://www.idquantique.com/quantum-safe-crypto/>

5.2. The One-Time Pad

The one-time pad, also known as a single-use key, is an encryption method that is 100% secure in principle, provided that all requirements are fully met. Quantum physics merely helps meet these requirements, whereas the method itself is a classical encryption technique.

Imagine an encryption key that consists entirely of a perfectly random sequence of 0s and 1s called "bits". Now imagine the message also consists of 0s and 1s. Binary addition of the message and encryption key can be performed to obtain another chain of 0s and 1s which is completely random as well. This results in the encrypted message.

The “calculation rules” that apply for binary addition are as follows:

- $0 + 0 = 0$
- $1 + 0 = 1$
- $0 + 1 = 1$
- $1 + 1 = 0$

When the intended recipient obtains the encrypted message, they will use binary addition on the encrypted message and encryption key. This will then produce the original message.

By way of an example, we can encode the word “Test”. Each letter can be translated into a five-digit binary code as shown in the table below (see Chapter 9 for a table that converts alphabet letters to binary code):

Word	T					E					S					T										
Binary word	1	0	0	1	1	0	0	1	0	0	1	0	0	1	0	1	0	0	1	0	0	1	0	0	1	1
	+																									
Key (random)	1	1	0	1	0	1	0	0	0	0	1	1	0	1	0	0	1	0	0	1	1	1	0	1	0	1
Encrypted message	0	1	0	0	1	1	0	1	0	1	0	1	0	1	1	0	0	1	1	0	1	1	1	1	0	0
	+																									
Key (as above)	1	1	0	1	0	1	0	0	0	0	1	1	0	1	0	0	1	0	0	1	1	1	1	1	0	1
Binary word	1	0	0	1	1	0	0	1	0	0	1	0	0	1	0	1	0	0	1	0	1	0	0	1	0	1
Word	T					E					S					T										

If the encrypted message is intercepted, the eavesdropper requires the key in order to decode it. Without the key, the random sequence of zeroes and ones produce complete "gibberish" when converted to a word. This makes the message entirely safe from interception.

To summarize the essential requirements:

1. The key has to be at least as long as the message.
2. The key must only be used once.
3. The key must be completely random.
4. The key must be known only to the sender and the recipient.

Requirement 1 is easy to meet by the sender, who can only encrypt a number of bits that is less than or equal to the number of available key bits.

Requirement 2 is the responsibility of the sender and recipient, and is easily realizable as well.

Requirement 3 is difficult to meet upon closer inspection, since every random number generator is ultimately based on an algorithm. This means that random numbers generated by a computer are always merely “pseudo-random”. However, quantum physics can be used to solve this problem since it makes true randomness possible. This is discussed in more detail in Section 5.5.

Requirement 4 is problematic as well, since the classical transmission of a key opens up the possibility of intercepting it. This problem too can be solved with quantum physics. The approach to the secret distribution of the key is discussed in the next subsection.

5.3. Key Distribution

5.3.1. $\lambda/2$ Plate and Data Transmission with One Basis

This subsection is intended to facilitate a better understanding of the experimental setup by briefly running through the process of transmitting data with one basis. Actual quantum cryptography (in the real world and in this analogy experiment) works with two bases, which is described in the next subsection.

A photon is to be used to transmit a “0” or a “1”. In this example, the polarization direction is used as the bit: A photon with horizontal polarization is interpreted as a “0”, one with vertical polarization as a “1”.

So what would an experimental setup look like that can transmit data this way? An example is shown in Figure 2.

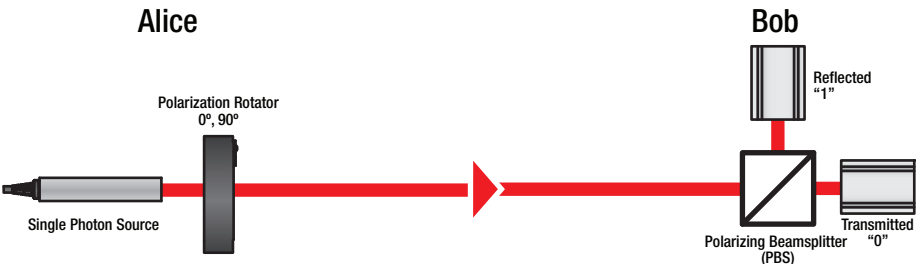

Figure 2 Data Transmission with One Polarization Basis

The sending unit “Alice” consists of a single photon source which is polarized horizontally and a $\lambda/2$ plate.

The $\lambda/2$ plate rotates the polarization of the incident light by **double** the physical rotation angle of the wave plate. For example, when the wave plate is rotated physically by 45° relative to the incoming polarization, the polarization of the light is actually rotated by 90° . This is why a $\lambda/2$ plate is also known synonymously as a “polarization rotator”.

When we talk about the “0°” and “90°” settings from now on (later “-45°” and “45°”), this angle always refers to the rotation angle of the polarization and never the rotation angle of the $\lambda/2$ plate.

A sketch describing how the $\lambda/2$ plate operates is shown in the diagram to the right. Light incident on the wave plate is altered such that polarization components not aligned with the fast axis of the birefringent crystal are retarded. For linearly polarized light, the result is that the polarization is rotated by a value twice as large as the rotation of the $\lambda/2$ plate.

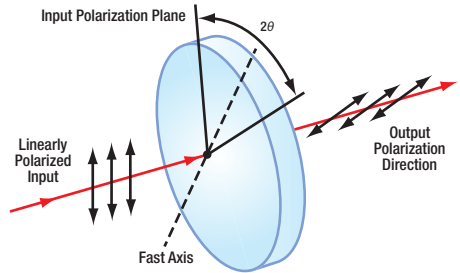

The receiving unit “Bob” consists of a polarizing beamsplitter cube and two detectors. The polarizing beamsplitter cube reflects the vertically-polarized (90°) component of the incident light, while passing the horizontally-polarized (0°) component, as seen in the diagram to the right.

If the polarization state of the light sent by Alice is set to 0° , the photon will pass through the beamsplitter (designated as event “0”). If the wave plate is set to rotate the polarization by 90° , the photon will be reflected by the beamsplitter (designated as event “1”).

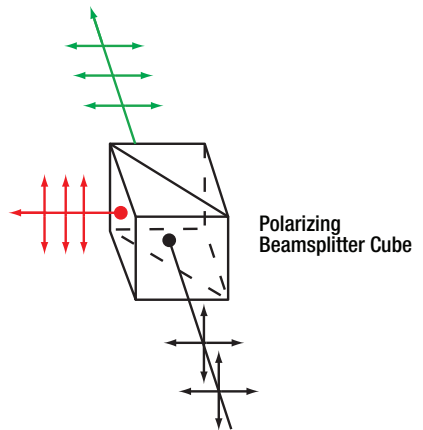

5.3.2. Key Distribution – The Right Way

While the method with one basis (0° or 90°) is sufficient to transfer data from Alice to Bob, it is not able to guarantee safety from interception. A second basis comes into play to accomplish this. In addition to the basis with 0° and 90° , which we will now call the “+ basis”, a second basis with -45° and 45° is used. From here on we will call it the “x basis”.

Now the setup looks like Figure 3. This is also the setup used for quantum cryptography and for this experiment package.

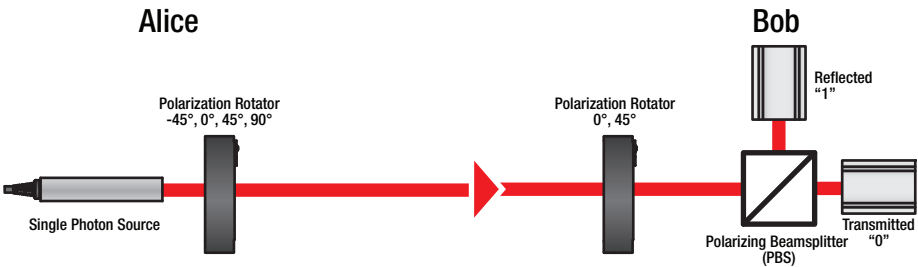

Figure 3 Quantum Cryptography Setup with the Bases + (0° and 90°) and x (-45° and 45°)

Now Alice has to make two *random* decisions for key generation:

- Alice has to select her basis at random, + or x
- Alice has to select a random bit, 0 or 1
 - Selecting 0 with the + basis means the setting 0°
 - Selecting 1 with the + basis means the setting 90°
 - Selecting 0 with the x basis means the setting -45°
 - Selecting 1 with the x basis means the setting 45°

Bob sets his polarization rotator to differentiate between the + and x bases. Accordingly Bob only needs the settings 0° and 45° .

If Bob selected the + basis and Alice sends in the + basis, Bob obtains an unambiguous result; this applies correspondingly if both choose the x basis. But what if Bob chooses a different basis than Alice? The result of choosing a different basis than Alice is that 45° polarized light will be sent to the beamsplitter. For a continuous beam, half is transmitted and half is reflected. However, assuming that only one photon is sent, only one of the two detectors can respond. The detector that responds is then left to chance. If the two bases do not match, Bob will nevertheless measure a signal on one of the two detectors. The probability of detecting the photon on one of the two detectors is 50% respectively.

In the table that follows, the different cases are shown again as an overview:¹

Alice			Bob				Same basis?
Basis	Bit	Angle	Basis	Angle	Detector "0"	Detector "1"	
+	0	0°	+	0°	100%	0%	Yes
+	1	90°	+	0°	0%	100%	Yes
x	1	45°	+	0°	50%	50%	No
x	0	-45°	+	0°	50%	50%	No
+	0	0°	x	45°	50%	50%	No
+	1	90°	x	45°	50%	50%	No
x	1	45°	x	45°	100%	0%	Yes
x	0	-45°	x	45°	0%	100%	Yes

If Alice were to send a signal comprising of random bits in random bases and Bob analyzed the signal using a random basis – how does this become the key for data transmission?

The answer is that both Alice and Bob will tell each other which BASIS is being used to transmit each bit at a later time. In the last three columns of the table, the result is only unambiguous (100%) when the bases are the same.

In practice, Alice and Bob will go through each of the measurements and only communicate "+" or "x". When the two are different, both discard the measurement. But if both bases are the same, then BOTH know which BIT was transmitted based on the result obtained by Bob's detectors. The bases, not the bits, are ever communicated publicly. Therefore the encryption key is derived from the measurements in which Alice and Bob chose the same basis.

As soon as Alice and Bob have gone through all measurements this way, both are in possession of the (random) key. Now Alice can encrypt the message and send it in the + basis. Bob receives the message in the + basis and is then able to decrypt it.

Section 5.4 expands on this protocol and introduces an eavesdropper into the process. The results of the same exercise have much different results, which allow Alice and Bob to detect the presence of this eavesdropper.

¹ If slight variations of the table should be found in other implementations of this experiment, this is probably caused by a different polarization of the incident laser. If it is vertical, then the 0° (Alice) and 0° (Bob) make a digital 1.

5.4. Detection of an Eavesdropper

Let us examine the situation of an eavesdropper “Eve” placed between Alice and Bob. Eve consists of the same components as Alice and Bob, only in the reverse sequence. This is shown in Figure 4.

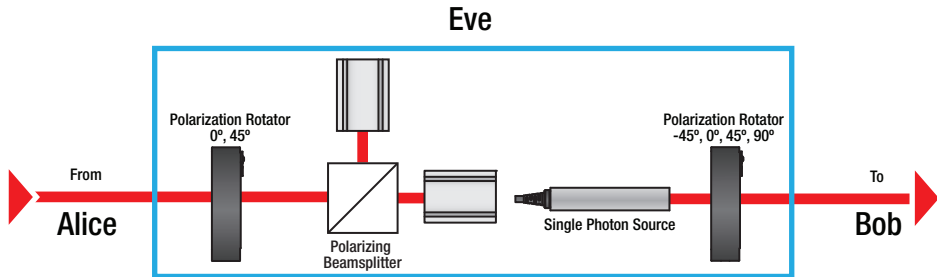

Figure 4 Eavesdropper Eve between Alice and Bob

Eve is placed in a position to measure the light coming from Alice and then attempt to transmit the identical information to Bob. Consider the following two possibilities:

- **Eve chooses the same basis as Alice:** In this case, Eve measures the signal that Alice sends correctly. Therefore, Eve will transmit the correct result to Bob in the same basis that was initially sent by Alice. Now Bob randomly chooses his basis, and once again there are two possibilities:
 - **Bob chooses the same basis as Alice:** Eve has transmitted the signal correctly using the same basis. Thus Bob obtains exactly the polarization state sent by Alice without detecting the presence of Eve.
 - **Bob chooses the other basis:** The basis used to receive the signal is different than the basis of the signal transmitted by Eve. Therefore, one of his detectors will respond at random. However, when Alice and Bob now compare their bases (same result as in the preceding subsection), this measurement is discarded anyway because of the different bases used by Alice and Bob.
- **Eve chooses the wrong basis:** In this case, Eve chooses a basis that differs from the one used by Alice and one of Eve's detectors will respond at random. Therefore, Eve is not able to judge whether she chose the correct basis. When Eve sends her signal to Bob, she will send the bit in the same basis that she received Alice's signal with.

Because Bob is also randomly choosing his basis, there are two possibilities:

- Bob chooses a different basis than Alice: This measurement is discarded after Alice and Bob compare bases.
- Bob chooses the same basis as Alice: This case produces the error which allows Alice and Bob to detect Eve eavesdropping. Keep in mind that Alice and Bob have confirmed that they sent and received the signal using the same basis, so the measurement is not discarded. However, Eve was eavesdropping in a different basis. This means two random detections took place: Eve in intercepting Alice's signal (because her basis did not match Alice's) and Bob's in receiving the intercepted signal (because his basis did not match Eve's).

In half of the cases the correct detector responds for Bob, so that he receives the same bit which Alice sent. But in the other half of the cases, the other detector will detect the photon. Therefore Bob obtains a different bit than the one sent by Alice.

To summarize: This represents a case where Alice and Bob obtain *different bits with the same bases* (which can never happen without third party interference). Therefore, the test for a spy is simple. After Alice and Bob have compared bases, they choose a certain number of bits with matching bases to compare publicly. If these test bits are identical, then there was no eavesdropper in the system.² But if errors are found in approximately 25% of the compared bits, then the communication was intercepted.

Although it may appear that Eve is only discovered only after eavesdropping, this is not the case since only one test encryption key has been generated so far. Even if Eve was eavesdropping (and therefore intercepted a certain number of bits undetected), this is inconsequential since no part of the actual message has been encoded or transmitted.

The individual cases are presented again briefly in a table for an overview. Only the cases where Alice and Bob use the same bases are considered here. The remaining measurements are discarded during the basis comparison process.³

Basis used by Alice and Bob	Basis used by Eve	Error?	Bits match for Alice and Bob
++	+	No	100%
++	x	In part	50%
xx	+	In part	50%
xx	x	No	100%

² Statistically it is possible for all test bits to be randomly correct. Therefore the sample size of bits must be large enough to ensure that the result is statistically significant.

³ The 25% error rate can be calculated from the table. If Alice and Bob choose the + basis, then Eve also chooses the + basis in 50% of all cases, which cannot be detected. But in 50% of all cases she chooses the x basis. Furthermore, in 50% of these cases the correct detector responds due to the random chance associated with an incorrect signal transmission. Therefore, the total error rate is $50\% \times 50\% = 25\%$.

5.5. What Does “Random” Mean?

As described in Section 5.2, the one-time pad requires the completely random selection of the encryption key. This means computer-generated, pseudo-random numbers are not a solution for 100% security. However, quantum physics offers numerous possibilities for true randomness. For example, a photon that hits a 50:50 non-polarizing beamsplitter is transmitted or reflected entirely at random. Half are transmitted and the other half reflected on average, but the “decision” of an individual photon is completely random. While this particular principle applies to photons, many other processes such as radioactive decay are also entirely random.

In practice, we can interpret a photon reflected by the beamsplitter as a binary 0 and a photon transmitted through the beamsplitter as a binary 1. In the case of conventional light incident on two single photodetectors after a beamsplitter, if the intensity on the detectors is the same, then the distribution of hits on the detectors can be considered completely random as well.

Particularly, quantum physics random number generators are a key component of quantum cryptography data networks. Some commercially available options already exist: <http://www.idquantique.com/random-number-generation/>.

5.6. What prevents one from simply copying the information?

Consider the scenario where Eve could simply copy the photon carrying the information. In this case, the security of quantum cryptography would be wiped out, since she could send the original photon on to Bob and carry out her measurement on the copied photon. Eve could then intercept the key bits without Alice and Bob detecting the eavesdropping.

However, the exact copying of a quantum physics state is actually impossible. This principle is known as the “no-cloning theorem” which was formulated and proven in 1982. In general, this theorem states that no quantum state can be exactly copied without altering its state. Therefore, Eve could not copy a photon from Alice without altering it, and cannot send an unaltered photon to Bob while keeping a copy for analysis.

5.7. Experimental Procedure

The sequence of steps for this experiment are taken from the the BB84 protocol. You can find the original publication here:

<http://researcher.watson.ibm.com/researcher/files/us-bennetc/BB84highest.pdf>

The sequence of the BB84 protocol experiment is:

1. Key transmission	<p>Alice chooses a random basis (x or +) and a bit (0 or 1). Bob then randomly chooses his basis (x or +). Both set their wave plates accordingly. Then the photon is sent through the setup (with us, the laser pulse).</p> <p>Bob notes whether he measured a 0 or a 1.</p> <p>Repeat this step many times.</p>
2. Erasing incorrect bases	<p>Alice and Bob go through their measurements and tell each other which bases they chose. They keep the bits measured when bases used by both Alice and Bob were the same. Any others are discarded from the sequence.</p> <p>Note: Only the bases are communicated between Alice and Bob (this can even be done publicly).</p> <p>After comparison, the remaining bits become the secret encryption key between Alice and Bob.</p>
3. Testing for a spy	<p>Alice and Bob publicly compare a sample of the transmitted bits in step 2. If errors exist, this confirms the presence of a spy and the key is erased.</p> <p>However, if no eavesdropper is detected, the test bits are removed and the remaining bits are the final encryption key.</p>
4. Encrypting the message	<p>Using the key generated in step 3, Alice can encrypt the message.</p>
5. Transmitting the message	<p>Alice sends the encrypted message to Bob. This is done publicly.</p>
6. Decrypting the message	<p>Bob decrypts the message with the help of the generated encryption key.</p>

There are additional steps in the protocol, which are not implemented for this experiment:

- **Authentication:** A few bits are exchanged at the start of communication according to a key established by Alice and Bob in advance. This step allows Alice to authenticate that she is communicating with Bob and not someone else.

If no errors occur then this confirms there is no eavesdropper in the line at the outset. One way to accomplish this step is to save a few bits from a previous communication for authentication in the next communication.

- **Error correction:** Since no system is perfect and measuring errors always occur, certain algorithms are used for error correction. These algorithms are not discussed here as it is outside the scope of the experiment.

5.8. Classical Light Versus Single Photons

The one major difference between this analogous experiment and a true quantum cryptography setup is that genuine safety from interception can only be guaranteed if a single photon source is used. This means the information of a bit has to be transported only by a single photon, since according to Section 5.6 it cannot be copied or measured without changes.

If any classical light source (even weakened lasers) is used instead of a single photon source, then Eve cannot be detected. All that is required to eavesdrop is for Eve to separate a portion of the transmitted light for detection/analysis while sending the remainder to Bob unnoticed.

Because the experiment detailed in this kit uses a pulsed light source (still not a single photon source), it cannot truly be employed as a perfect encryption system. However, the sequence of the protocol is completely identical to a true quantum encryption system.

5.9. Mathematical Description in Dirac-Notation

Up to here, we described the experiments qualitatively. The preparation of the polarization states and their measurement by Bob (and Eve) are comprehensive parts of the experimental realization. However, every physical theory requires a mathematical description as well. In the following, we cast the experiments into formulas.

A suitable notation must first be found. For polarization states, Dirac's Bra-Ket Notation is an elegant choice. The four polarization states in this experiment are symbolized as

$$|-45^\circ\rangle, |0^\circ\rangle, |45^\circ\rangle, |90^\circ\rangle \quad (1)$$

where $|0^\circ\rangle$ and $|90^\circ\rangle$ are the basis states of the + basis and $|-45^\circ\rangle$ and $|45^\circ\rangle$ are the basis states of the x basis. The elegance of Dirac's notation lies in the fact that a state can be expressed and processed even if no distinct coordinate system has been chosen.

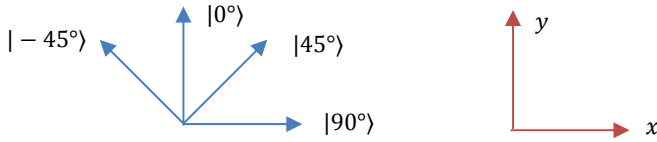

When a coordinate system has been chosen (to the right, xy), the states can be written in vector form as

$$|0^\circ\rangle = \begin{pmatrix} 0 \\ 1 \end{pmatrix}, \quad |90^\circ\rangle = \begin{pmatrix} 1 \\ 0 \end{pmatrix} \tag{2}$$

An important mathematical tool is the scalar product which is performed in the following way⁴

$$\langle 90^\circ | 0^\circ \rangle = (1 \ 0) \cdot \begin{pmatrix} 0 \\ 1 \end{pmatrix} = 0 \tag{3}$$

The squared absolute value of the scalar product ($|\langle 90^\circ | 0^\circ \rangle|^2$) is a descriptive quantity that represents the probability that a 0° -polarized photon passes through a polarizer oriented in the 90° direction. Naturally, this probability is 0 which is consistent with equation (3).

The states can also be expressed as linear combinations, e.g.,

$$|45^\circ\rangle = \alpha \cdot |0^\circ\rangle + \beta \cdot |90^\circ\rangle \tag{4}$$

Since the scalar product has to be normalized, it is show that

$$1 \stackrel{!}{=} |\langle 45^\circ | 45^\circ \rangle|^2 = \alpha^* \alpha \underbrace{\langle 0^\circ | 0^\circ \rangle}_{=1} + \alpha^* \beta \underbrace{\langle 0^\circ | 90^\circ \rangle}_{=0} + \alpha \beta^* \underbrace{\langle 90^\circ | 0^\circ \rangle}_{=0} + \beta \beta^* \underbrace{\langle 90^\circ | 90^\circ \rangle}_{=1} = |\alpha|^2 + |\beta|^2 \tag{5}$$

Due to symmetry it follows that $\alpha = \beta = 1/\sqrt{2}$. Therefore, all four states can be expressed as:

$$\begin{aligned} |45^\circ\rangle &= \frac{1}{\sqrt{2}} |0^\circ\rangle + \frac{1}{\sqrt{2}} |90^\circ\rangle \\ |-45^\circ\rangle &= \frac{1}{\sqrt{2}} |0^\circ\rangle - \frac{1}{\sqrt{2}} |90^\circ\rangle \\ |0^\circ\rangle &= \frac{1}{\sqrt{2}} |45^\circ\rangle + \frac{1}{\sqrt{2}} |-45^\circ\rangle \\ |90^\circ\rangle &= \frac{1}{\sqrt{2}} |45^\circ\rangle - \frac{1}{\sqrt{2}} |-45^\circ\rangle \end{aligned} \tag{6}$$

A vector representation can also be chosen, e.g., $|\pm 45^\circ\rangle = (\pm 1/\sqrt{2}, 1/\sqrt{2})^T$. The probability that a 0° -polarized photon passes a 45° oriented polarizer can now be calculated:

⁴ To be precise: $|\langle a|b\rangle|^2 = \langle a|b\rangle \cdot \langle a|b\rangle^* = \langle a|b\rangle \langle b|a\rangle$, where a^* is the complex conjugate of a .

$$|\langle 45^\circ | 0^\circ \rangle|^2 = \left| \frac{1}{\sqrt{2}} \underbrace{\langle 45^\circ | 45^\circ \rangle}_{=1} + \frac{1}{\sqrt{2}} \underbrace{\langle 45^\circ | -45^\circ \rangle}_{=0} \right|^2 = \frac{1}{2} \quad (7)$$

This means that the probability of a 0° -polarized photon passing a 45° oriented polarizer is 50%.

In the experiment, however, Bob and Eve only decide for a basis to measure in (+ or x) and observe which detector responds. The question is how to express that mathematically. In order to do so, operators \hat{M}_+ and \hat{M}_x are introduced that each describe a measurement in either one or the other basis.

$$\begin{aligned} \hat{M}_+ &= |0^\circ\rangle\langle 0^\circ| - |90^\circ\rangle\langle 90^\circ| \\ \hat{M}_x &= |45^\circ\rangle\langle 45^\circ| - |-45^\circ\rangle\langle -45^\circ| \end{aligned} \quad (8)$$

First, the operator of the + basis acts on the vertically and horizontally polarized state:

$$\begin{aligned} \hat{M}_+ |0^\circ\rangle &= |0^\circ\rangle\langle 0^\circ|0^\circ\rangle - |90^\circ\rangle\langle 90^\circ|0^\circ\rangle = |0^\circ\rangle - |90^\circ\rangle \cdot 0 = |0^\circ\rangle \\ \hat{M}_+ |90^\circ\rangle &= |0^\circ\rangle\langle 0^\circ|90^\circ\rangle - |90^\circ\rangle\langle 90^\circ|90^\circ\rangle = |0^\circ\rangle \cdot 0 - |90^\circ\rangle = -|90^\circ\rangle \end{aligned} \quad (9)$$

The result is not too surprising – when the vertical or horizontal state is measured in the + basis we retrieve the state itself. Note that the observable \hat{M}_+ is the quantity to be measured while the eigenvectors (namely $|0^\circ\rangle, |90^\circ\rangle$) are the possible states of the system.⁵ The eigenvalues (namely ± 1) represent the possible outcomes of the measurement. Here, +1 corresponds to the transmission of the photon and -1 corresponds to the reflection (which, in turn, can be interpreted as the phase jump occurring due to the reflection).

The diagonally polarized states behave accordingly when measured in the diagonal basis:

$$\begin{aligned} \hat{M}_x |45^\circ\rangle &= |45^\circ\rangle\langle 45^\circ|45^\circ\rangle - |-45^\circ\rangle\langle -45^\circ|45^\circ\rangle = |45^\circ\rangle \\ \hat{M}_x |-45^\circ\rangle &= |45^\circ\rangle\langle 45^\circ|-45^\circ\rangle - |-45^\circ\rangle\langle -45^\circ|-45^\circ\rangle = -|-45^\circ\rangle \end{aligned} \quad (10)$$

The eigenvalue -1 does not correspond to the reflection in our setup, though (since the state $|-45^\circ\rangle$ corresponds to the transmission and, therefore, Bit 0). This can be understood by noting that we do not tilt the beamsplitter for a measurement in the diagonal basis but instead rotate the incident polarization by means of a $\lambda/2$ -wave plate at the receiving unit.

What happens, though, when a 45° -polarized photon is measured in the + basis? In equation (7) it was shown that the transmission probability of this photon through a 0° polarizer can be calculated as 50%. Calculating the state yields a superposition of the $|0^\circ\rangle$ and $|90^\circ\rangle$ states:

⁵ *Reminder: when the equation $\hat{M}|x\rangle = \chi|x\rangle$ holds for a state $|x\rangle$ and an operator \hat{M} , we call $|x\rangle$ an eigenvector of the operator \hat{M} with eigenvalue χ .*

$$\begin{aligned}
\hat{M}_+ |45^\circ\rangle &= |0^\circ\rangle\langle 0^\circ| \left(\frac{1}{\sqrt{2}} |0^\circ\rangle + \frac{1}{\sqrt{2}} |90^\circ\rangle \right) - |90^\circ\rangle\langle 90^\circ| \left(\frac{1}{\sqrt{2}} |0^\circ\rangle + \frac{1}{\sqrt{2}} |90^\circ\rangle \right) \\
&= \frac{1}{\sqrt{2}} |0^\circ\rangle\langle 0^\circ|0^\circ\rangle + \frac{1}{\sqrt{2}} |0^\circ\rangle\langle 0^\circ|90^\circ\rangle - \frac{1}{\sqrt{2}} |90^\circ\rangle\langle 90^\circ|0^\circ\rangle \\
&\quad - \frac{1}{\sqrt{2}} |90^\circ\rangle\langle 90^\circ|90^\circ\rangle = \frac{1}{\sqrt{2}} |0^\circ\rangle - \frac{1}{\sqrt{2}} |90^\circ\rangle \\
\hat{M}_+ |-45^\circ\rangle &= \frac{1}{\sqrt{2}} |0^\circ\rangle + \frac{1}{\sqrt{2}} |90^\circ\rangle
\end{aligned} \tag{11}$$

Similarly, measuring a vertically or horizontally polarized photon in the diagonal basis results in:

$$\begin{aligned}
\hat{M}_\times |0^\circ\rangle &= \frac{1}{\sqrt{2}} |45^\circ\rangle - \frac{1}{\sqrt{2}} |-45^\circ\rangle \\
\hat{M}_\times |90^\circ\rangle &= \frac{1}{\sqrt{2}} |45^\circ\rangle + \frac{1}{\sqrt{2}} |-45^\circ\rangle
\end{aligned} \tag{12}$$

Now we know how the photon states change. In the following, we can mathematically describe the measurements and states for Alice, Bob, and Eve as described in the previous sections.⁶ We start with a table describing the situation without Eve. Afterwards, a table presenting the description including Eve is shown.

⁶ Note that all calculations could also be performed in the vector representation. The state's representation was described above. The operator's representations are matrices, namely $\hat{M}_+ = \begin{pmatrix} -1 & 0 \\ 0 & 1 \end{pmatrix}$ and $\hat{M}_\times = \begin{pmatrix} 0 & 1 \\ 1 & 0 \end{pmatrix}$.

Alice		Bob		
State	Basis, Bit	Chosen Basis	State	Measured Bit
$ 0^\circ\rangle$	+, 0	+	$\hat{M}_+ 0^\circ\rangle = 0^\circ\rangle$	0
		×	$\hat{M}_\times 0^\circ\rangle = \frac{1}{\sqrt{2}} 45^\circ\rangle - \frac{1}{\sqrt{2}} -45^\circ\rangle$	0 or 1
$ 90^\circ\rangle$	+, 1	+	$\hat{M}_+ 90^\circ\rangle = - 90^\circ\rangle$	1
		×	$\hat{M}_\times 90^\circ\rangle = \frac{1}{\sqrt{2}} 45^\circ\rangle + \frac{1}{\sqrt{2}} -45^\circ\rangle$	0 or 1
$ 45^\circ\rangle$	×, 1	+	$\hat{M}_+ 45^\circ\rangle = \frac{1}{\sqrt{2}} 0^\circ\rangle - \frac{1}{\sqrt{2}} 90^\circ\rangle$	0 or 1
		×	$\hat{M}_\times 45^\circ\rangle = 45^\circ\rangle$	1
$ -45^\circ\rangle$	×, 0	+	$\hat{M}_+ -45^\circ\rangle = \frac{1}{\sqrt{2}} 0^\circ\rangle + \frac{1}{\sqrt{2}} 90^\circ\rangle$	0 or 1
		×	$\hat{M}_\times -45^\circ\rangle = - -45^\circ\rangle$	0

- Bases of Alice & Bob Identical → Bit can be Used as Key Bit
- Bases of Alice & Bob Not Identical → Measurement is Discarded

Alice		Eve			Bob		
Basis, Bit	State	Basis	State	State Sent	Basis	State	Measured Bit
+,0	0°>	+	$\hat{M}_+ 0^\circ\rangle = 0^\circ\rangle$	0°>	+	$\hat{M}_+ 0^\circ\rangle = 0^\circ\rangle$	0
					×	$\hat{M}_\times 0^\circ\rangle = \frac{1}{\sqrt{2}} 45^\circ\rangle - \frac{1}{\sqrt{2}} -45^\circ\rangle$	0 or 1
		×	$\hat{M}_\times 0^\circ\rangle = \frac{ 45^\circ\rangle}{\sqrt{2}} - \frac{ -45^\circ\rangle}{\sqrt{2}}$	45°> or -45°>	+	$\hat{M}_+ 45^\circ\rangle = \frac{1}{\sqrt{2}} 0^\circ\rangle - \frac{1}{\sqrt{2}} 90^\circ\rangle$ or $\hat{M}_+ -45^\circ\rangle = \frac{1}{\sqrt{2}} 0^\circ\rangle + \frac{1}{\sqrt{2}} 90^\circ\rangle$	0 or 1 0 or 1
					×	$\hat{M}_\times 45^\circ\rangle = 45^\circ\rangle$ or $\hat{M}_\times -45^\circ\rangle = - -45^\circ\rangle$	1 0
+,1	90°>	+	$\hat{M}_+ 90^\circ\rangle = - 90^\circ\rangle$	90°>	+	$\hat{M}_+ 90^\circ\rangle = - 90^\circ\rangle$	1
					×	$\hat{M}_\times 90^\circ\rangle = \frac{1}{\sqrt{2}} 45^\circ\rangle + \frac{1}{\sqrt{2}} -45^\circ\rangle$	0 or 1
		×	$\hat{M}_\times 90^\circ\rangle = \frac{ 45^\circ\rangle}{\sqrt{2}} + \frac{ -45^\circ\rangle}{\sqrt{2}}$	45°> or -45°>	+	$\hat{M}_+ 45^\circ\rangle = \frac{1}{\sqrt{2}} 0^\circ\rangle - \frac{1}{\sqrt{2}} 90^\circ\rangle$ or $\hat{M}_+ -45^\circ\rangle = \frac{1}{\sqrt{2}} 0^\circ\rangle + \frac{1}{\sqrt{2}} 90^\circ\rangle$	1 or 1 1 or 1
					×	$\hat{M}_\times 45^\circ\rangle = 45^\circ\rangle$ or $\hat{M}_\times -45^\circ\rangle = - -45^\circ\rangle$	1 0
×,1	45°>	+	$\hat{M}_+ 45^\circ\rangle = \frac{ 0^\circ\rangle}{\sqrt{2}} - \frac{ 90^\circ\rangle}{\sqrt{2}}$	0°> or 90°>	+	$\hat{M}_+ 0^\circ\rangle = 0^\circ\rangle$ or $\hat{M}_+ 90^\circ\rangle = - 90^\circ\rangle$	0 1
					×	$\hat{M}_\times 0^\circ\rangle = \frac{1}{\sqrt{2}} 45^\circ\rangle - \frac{1}{\sqrt{2}} -45^\circ\rangle$ or $\hat{M}_\times 90^\circ\rangle = \frac{1}{\sqrt{2}} 45^\circ\rangle + \frac{1}{\sqrt{2}} -45^\circ\rangle$	1 or 1 1 or 1
		×	$\hat{M}_\times 45^\circ\rangle = 45^\circ\rangle$	45°>	+	$\hat{M}_+ 45^\circ\rangle = \frac{1}{\sqrt{2}} 0^\circ\rangle - \frac{1}{\sqrt{2}} 90^\circ\rangle$	0 or 1
					×	$\hat{M}_\times 45^\circ\rangle = 45^\circ\rangle$	1
×,0	-45°>	+	$\hat{M}_+ -45^\circ\rangle = \frac{ 0^\circ\rangle}{\sqrt{2}} + \frac{ 90^\circ\rangle}{\sqrt{2}}$	0°> or 90°>	+	$\hat{M}_+ 0^\circ\rangle = 0^\circ\rangle$ or $\hat{M}_+ 90^\circ\rangle = - 90^\circ\rangle$	0 1
					×	$\hat{M}_\times 0^\circ\rangle = \frac{1}{\sqrt{2}} 45^\circ\rangle - \frac{1}{\sqrt{2}} -45^\circ\rangle$ or $\hat{M}_\times 90^\circ\rangle = \frac{1}{\sqrt{2}} 45^\circ\rangle + \frac{1}{\sqrt{2}} -45^\circ\rangle$	1 or 1 1 or 1
		×	$\hat{M}_\times -45^\circ\rangle = - -45^\circ\rangle$	-45°>	+	$\hat{M}_+ -45^\circ\rangle = \frac{1}{\sqrt{2}} 0^\circ\rangle + \frac{1}{\sqrt{2}} 90^\circ\rangle$	0 or 1
					×	$\hat{M}_\times -45^\circ\rangle = - -45^\circ\rangle$	0

 Bases of Alice & Bob & Eve Identical → Eve is Not Noticed
 Bases of Alice & Bob Not Identical → Measurement is Discarded Anyway
 / Bases of Alice & Bob Identical; Bits are Incidentally Identical, Eve is Not Noticed
 / Bases of Alice & Bob Identical; Bits Incidentally Differ → <i>Eve is Uncovered</i>

Chapter 6 Examples

6.1. Encryption Protocol without Eve (Two Letters)

Step 1: Alice and Bob randomly select their bases, and Alice also selects her bits

Alice

	1	2	3	4	5	6	7	8	9	10	11	12	13	14	15	16	17	18
Basis	x	x	+	x	+	+	+	x	x	+	x	x	x	+	+	x	+	x
Bit	1	0	0	1	1	0	0	1	1	1	0	1	0	0	0	1	0	1

Bob

	1	2	3	4	5	6	7	8	9	10	11	12	13	14	15	16	17	18
Basis	+	x	x	x	+	+	+	x	+	x	x	+	+	x	+	+	+	x
Bit																		

Step 2: Alice sends the bits in the chosen basis and Bob records the bits he measures. During Bob's measurements, he uses the bases chosen randomly by him. Bob will then interpret Alice's transmission as in the example below. Please note that in cases where the bases do not match, a 0 or 1 bit result is selected at random.

Bob

	1	2	3	4	5	6	7	8	9	10	11	12	13	14	15	16	17	18
Basis	+	x	x	x	+	+	+	x	+	x	x	+	+	x	+	+	+	x
Bit	1	0	1	1	1	0	0	1	1	1	0	1	0	1	0	0	0	1

Step 3: Alice and Bob exchange their bases (“I have +” or “I have x”). Both Alice and Bob will note which of the transmitted bits were sent using the same basis (see below):

Alice

	1	2	3	4	5	6	7	8	9	10	11	12	13	14	15	16	17	18
Basis	x	x	+	x	+	+	+	x	x	+	x	x	x	+	+	x	+	x
Bit	1	0	0	1	1	0	0	1	1	1	0	1	0	0	0	1	0	1

Bob

	1	2	3	4	5	6	7	8	9	10	11	12	13	14	15	16	17	18
Basis	+	x	x	x	+	+	+	x	+	x	x	+	+	x	+	+	+	x
Bit	1	0	1	1	1	0	0	1	1	1	0	1	0	1	0	0	0	1

The resulting key generated by the two of them is: “0 1 1 0 0 1 0 0 0 1”. Both know this key even though they have only exchanged their bases.

Step 4: Alice encrypts two letters with the key that was just generated. Read the binary representation of Q and M from the alphabet table, then perform binary addition on the first and second rows, see Chapter 9 for reference tables.

Letter	Q					M				
Data Bit	1	0	0	0	0	0	1	1	0	0
Key Bit	0	1	1	0	0	1	0	0	0	1
Encrypted Bit	1	1	1	0	0	1	1	1	0	1

Step 5a: Alice sends the encrypted message using the + basis (0° to indicate 0 and 90° to indicate 1). She therefore selects the following angle settings in the sequence below:

90°, 90°, 90°, 0°, 0°, 90°, 90°, 90°, 0°, 90°

Step 5b: Bob receives Alice’s transmission using the + basis as well (reflected light = 1, transmitted light = 0). Bob will record the following received bits:

Received Bit	1	1	1	0	0	1	1	1	0	1
---------------------	---	---	---	---	---	---	---	---	---	---

Step 6: Bob then uses the encryption key to decode the message (binary addition of the first and second lines)

Received Bit	1	1	1	0	0	1	1	1	0	1
Key Bit	0	1	1	0	0	1	0	0	0	1
Data Bit	1	0	0	0	0	0	1	1	0	0
Letter	Q					M				

6.2. Encryption Protocol with Eve

The process of generating the key is discussed again here, but this time with Eve who is eavesdropping. Her presence is discovered by comparing test bits.

Step 1: Alice, Bob and Eve randomly select their bases, and Alice also randomly selects bits to send.

Alice

	1	2	3	4	5	6	7	8	9	10	11	12	13	14	15	16	17	18
Basis	x	x	+	x	+	+	+	x	x	+	x	x	x	+	+	x	+	x
Bit	1	0	0	1	1	0	0	1	1	1	0	1	0	0	0	1	0	1

Bob

	1	2	3	4	5	6	7	8	9	10	11	12	13	14	15	16	17	18
Basis	+	x	x	x	+	+	+	x	+	x	x	+	+	x	+	+	+	x
Bit																		

Eve

	1	2	3	4	5	6	7	8	9	10	11	12	13	14	15	16	17	18
Basis	x	x	+	+	x	+	+	+	x	x	x	x	+	x	+	x	+	+

Step 2: Alice then sends the bits using her selected basis and Bob records the bits he measures. However, in this scenario, Eve is between Alice and Bob and selects her basis randomly as well (either 0° and 45°). If Eve's basis matches the one chosen by Alice, Eve will transmit the correct bit. If Eve selected the incorrect basis, she will transmit a random bit based on her interpretation of Alice's signal (0 or 1). Bob, however will record the bit that he receives from Eve. The measurements performed by Eve and Bob will appear as in the table below (Eve's measurements are shown for explanatory reasons, but are generally hidden from both Alice and Bob⁷):

Eve

	1	2	3	4	5	6	7	8	9	10	11	12	13	14	15	16	17	18
Basis	X	X	+	+	X	+	+	+	X	X	X	X	+	X	+	X	+	+
Bit	1	0	0	0	1	0	0	1	1	0	0	1	1	1	0	1	0	1

Bob

	1	2	3	4	5	6	7	8	9	10	11	12	13	14	15	16	17	18
Basis	+	X	X	X	+	+	+	X	+	X	X	+	+	X	+	+	+	X
Bit	1	0	1	1	0	0	0	0	1	0	0	0	1	1	0	0	0	0

In the tables below, the same set of data measurements is presented but with all events determined by random chance highlighted in green. Green measurements in the first table indicate random events produced between Alice and Eve, while green measurements in the second table indicate random events produced between Eve and Bob.

In either case, neither Eve nor Bob know whether their measurement was randomly generated.

Eve

	1	2	3	4	5	6	7	8	9	10	11	12	13	14	15	16	17	18
Basis	X	X	+	+	X	+	+	+	X	X	X	X	+	X	+	X	+	+
Bit	1	0	0	0	1	0	0	1	1	0	0	1	1	1	0	1	0	1

Bob

	1	2	3	4	5	6	7	8	9	10	11	12	13	14	15	16	17	18
Basis	+	X	X	X	+	+	+	X	+	X	X	+	+	X	+	+	+	X
Bit	1	0	1	1	0	0	0	0	1	0	0	0	1	1	0	0	0	0

⁷ Similar to the experiment without Eve, the measurements where the bases do not match are random.

Step 3: At this point, Alice and Bob exchange the bases used for transmitting and receiving (“I have +” or “I have x”). They highlight the measurements where the bases match.

Alice

	1	2	3	4	5	6	7	8	9	10	11	12	13	14	15	16	17	18
Basis	x	x	+	x	+	+	+	x	x	+	x	x	x	+	+	x	+	x
Bit	1	0	0	1	1	0	0	1	1	1	0	1	0	0	0	1	0	1

Bob

	1	2	3	4	5	6	7	8	9	10	11	12	13	14	15	16	17	18
Basis	+	x	x	x	+	+	+	x	+	x	x	+	+	x	+	+	+	x
Bit	1	0	1	1	0	0	0	0	1	0	0	0	1	1	0	0	0	0

Step 4: Now Alice and Bob compare the bits for which their bases matched (the ones circled in red)

Alice: 0 1 (1) 0 0 (1) 0 0 0 (1)
 Bob: 0 1 (0) 0 0 (0) 0 0 0 (0)

As seen above, there are differences between the two bit sequences – these are circled in blue. The errors occurred three times out of ten, which is close to the expected 25%.⁸ The presence of errors in this test string alerts Alice and Bob to the presence of an eavesdropper and the protocol would be abandoned at this point.

⁸ There is no system underlying the numbers chosen here. The fact that Bob has so many zeroes is therefore pure chance. Furthermore, the combination of “Alice=1, Bob=0” three times for the incorrect pairs is random. When the random events marked in green are chosen differently, the bits compared by Alice and Bob also change correspondingly.

Chapter 7 Setup and Adjustment

7.1. Component Assembly

Screw the RDF1 feet onto all breadboards. To do this, use the 1/4"-20 x 1/2" (M6 x 12 mm) screws to secure four feet to the bottom of each breadboard.



<p>Take a BA1(M) base and screw one of the PH1.5 (PH40(M) post holders to it using a 1/4"-20 x 3/8" (M6 x 10 mm) screw. Insert a TR1.5 (TR40(M) post and screw the KM100 to it (see illustrations below). Insert the CPS635R-C2 laser into the AD11NT adapter ring which is secured in the KM100.</p>	<p>Take a BA1S(M) base and screw one of the PH2 (PH50(M) post holders to it. Insert a TR2 (TR50(M) post and screw the AT1(M) adjustment aid to it.</p>	<p>Take a BA1(M) base and screw one of the PH2 (PH50(M) post holders to it. Insert a TR2 (TR50(M) post. Remove the set screw from the TR2 (TR50(M) post using a hex key. Then screw the sensor unit (pictured below) to the post using the thread adapters Carry out these steps for all 4 sensors.</p>
		



Figure 5 Mounting a KM100 to a Ø1/2" Stainless Steel Post

Now set up the two beamsplitters: Use the UPH2 (UPH50/M) universal holder and insert a TR2 (TR50/M) post. Remove the set screw from the post with a hex key. Attach the KM100PM/M with a included cap screw. Attach the PM3(/M) supporting arm as shown in Figure 6. Use protective gloves to pick up the PBS201 and insert it in the orientation shown in photos below. It is secured by tightening the screw in the supporting arm. Verify the correct orientation (lettering on the bottom, edge correct).



Figure 6 Mount PBS201 Beamsplitter to Kinematic Platform



ATTENTION



Avoid touching the $\lambda/2$ plates with bare hands. Wearing gloves during assembly is strongly recommended. Only grasp the edge of optical components in order to avoid touching the surface with bare fingers.

Install the $\lambda/2$ -plates. First, screw a PH1.5 (PH40/M) post holder onto a BA1(/M) base. Screw a TR1.5 (TR30/M) post into the RSP1X225(/M)-ALICE indexing rotation mount (see image to the right). Unscrew the retaining ring by using the included SPW606 spanner wrench. Insert the $\lambda/2$ -plate and lock it in place with the retaining ring. Repeat the steps for all 4 rotation mounts. Two of the mounts are engraved with 0° and 45° markings while the other two rotation mounts are engraved with four markings (-45° , 0° , 45° , and 90°). The procedure for aligning these rotation mounts is described in Section 7.3.



7.2. Electronics

7.2.1. Power Supply

The power supply included in this kit is designed to provide a stabilized 5 V. Select the correct plug for your region and insert it in the jack on the power supply.



7.2.2. Laser Electronics

In addition to the connection for the power supply, the laser electronics box⁹ only has an input for the laser. An adapter cable is included to connect the laser electronics with the CPS635R-C2 laser module.



The laser electronics control unit features a fire button that is used to switch between pulse mode and continuous wave mode (see picture to the right). Hold the fire button down for 2 seconds to switch the laser to continuous wave mode. Pressing the fire button briefly ends the continuous wave mode so that short pulses are sent. The output of the laser is visible when a piece of paper is held in front of the laser. A green LED on the side of the laser electronics control unit indicates that it is ready for use.



⁹ Use the supplied power supply for operation. A user-supplied power unit must be a stabilized power supply with 5 V and min. 0.5 A (2.5 W) with a 5.5/2.1 mm power socket (positive terminal inside).

7.2.3. Sensor Electronics

The sensor electronics have a connection for the power supply and two sensor inputs. A sensor can be plugged into either of the two sensor ports. Ensure that the sensors are connected to the electronics box prior to inserting the power supply.

The sensor electronics box is equipped with a green button that is used to switch between “adjustment mode” and “measuring mode”. These modes determine how the sensor LEDs respond when a laser pulse is received by both sensors simultaneously.

In adjustment mode, the LED on the side of the box lights up yellow. When light of equal intensities is received by both sensors, the blue LEDs on both sensor will light up.

In measuring mode, the LED on the side of the box lights up green. When light of equal intensities is received by both sensors, one of the two blue LEDs (randomly selected) lights up. This effect simulates the “decision” of the single photon which is transmitted or reflected with 50% probability on the beamsplitter.



7.3. Adjusting the Laser and $\lambda/2$ -Plates

Before performing the experiment, the polarization plane of the laser and the orientation of the $\lambda/2$ -plates need to be aligned.

- First, place the laser and the beamsplitter on one of the breadboards.
 - Hold the fire button down for 2 seconds so the laser switches to continuous wave mode. This makes adjustment much easier.



WARNING



The laser module is a class 2 laser. Although no protective eyewear is required to operate class 2 lasers, do not look directly into the beam or into scattered light.

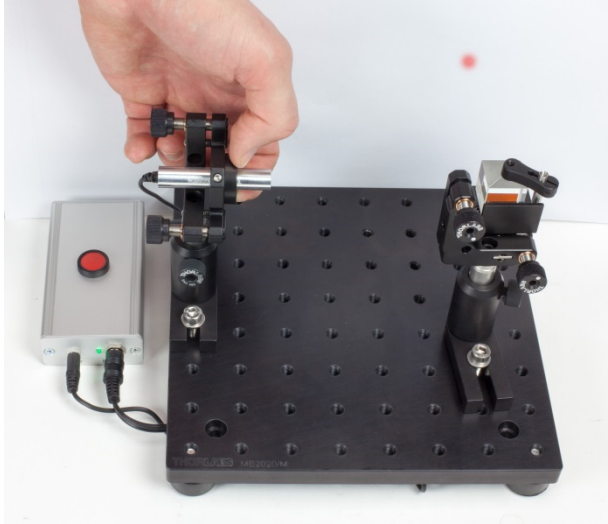

- Use the AT1/M height adjustment tool to ensure that the laser runs parallel to the tabletop. Adjust the laser tip/tilt using the adjusters on the KM100 mount, if necessary. To ensure the best alignment, use the AT1/M adjustment tool alternating between close and far distances from the laser during the alignment process.
- Position the laser and beamsplitter such that light reflected off the beamsplitter surface is at a 90° angle from the incoming beam.
- Now the laser is turned in its holder, rotating the polarization of the laser. While the laser does not have full linear polarization, it has a predominant direction. Slightly loosen the screw that clamps the adapter ring in the kinematic holder. Rotate the laser using the adapter ring. In order to keep it from sliding away, one should put pressure onto the adapter ring from the front with two fingers. Now use a sheet of paper to observe the laser intensity reflected by the beamsplitter cube. It should distinctly decrease and increase again during rotation. You are looking for the setting with the lowest intensity on the reflected path.
- Continue turning the laser until the intensity of the light reflecting off the beamsplitter is **minimal** and screw down the laser in this position.
- Take the entire assembly (laser and holder) out of the setup and repeat the previous steps using the other laser. After this process, both lasers should be horizontally polarized.

- Place the rotation mount (Item # RSP1X225(M)-ALICE) with the $\lambda/2$ plate between laser and beamsplitter, with the engraved dial face facing the laser.
 - Loosen the screw at the top of the rotation mount for continuous mode operation.

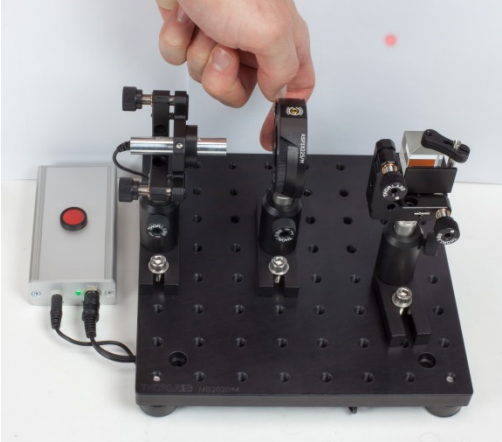

- Rotate the $\lambda/2$ plate and observe the reflected intensity. The intensity will vary with the rotation angle. Look for the orientation with the lowest reflected intensity.
- Once you've found the angle which minimizes the intensity of the reflected light, engage the indexing mode by tightening the screw at the top of the rotation mount.
- Take the rotation mount out of the setup and re-align the dial face. To do this, loosen the two small screws on the face of the mount. Rotate the dial face until the "0" mark is aligned with the small mark at the centered top part of the mount as shown in the photo below. The wave plate should not rotate during this step. Tighten the two screws on the face plate to secure the dial face.



- Repeat the previous steps with all rotation mounts and wave plates.

7.4. Setup for Alice and Bob

Alice and Bob should face each other at a distance of about 60 cm. For best performance, set up the two breadboards up as parallel as possible.

- Set up Alice (laser and the $\lambda/2$ plate) on the small breadboard. The rotation mount should be centered on the breadboard. The holder is engraved with markings “-45, 0, 45, 90” facing the laser. Set Alice’s laser to continuous mode (hold the red button down for 2 seconds).
- On the other breadboard (Bob), set up the other $\lambda/2$ plate directly at the edge of the breadboard. This wave plate holder is engraved with “0, 45” markings. The markings should point away from Alice.
- Place one of the two sensors at the other end of Bob’s breadboard (opposite the wave plate holder). Roughly align the position of the sensor so that the laser is incident on the detector.
- Place the beamsplitter in between Bob's wave plate holder and detector. It should be as close to perpendicular to the beam as possible.
- The second sensor should be placed such that:
 - Laser light from Alice that is reflected by the beamsplitter is incident on this detector. The sensors should be placed such that the entrance is perpendicular to the incident light.
 - The distance between both detectors and the beamsplitter is equal.

The setup should now look as follows:



Figure 7 Alice and Bob

Fine-Tuning the Alignment

- Set the sensor electronics to adjustment mode (the side LED lights up yellow).
- Set both polarization rotators to 0° and press the fire button. The blue LED on the sensor in the path of the laser should light up. If this is not the case, check:
 - That the sensor is actually perpendicular to the beam.
 - That the laser is incident on the opening in front of the detector in the sensor.

- That the sensor is at the correct height.
- That the laser light is centered on the hole in the sensor module.

If difficulties are encountered, have one user continue sending pulses with the laser while the other aligns the sensor.

When this sensor is configured correctly align the other sensor in the setup:

- Set the $\lambda/2$ plate of Alice to 90° on the scale (Bob stays at 0°). Now the LED on the other sensor (reflected from the beamsplitter) should light up when a pulse is sent from Alice.
- The tip/tilt of the beamsplitter cube can be adjusted to align the reflected beam with this sensor.

Repeat these alignment steps with other polarization rotation combinations:

For example, using polarizer rotation settings of 45° and -45° on Alice and a 0° setting on Bob, both sensor LEDs should light up. This is because the light is split by the beamsplitter and half of the total incident light reaches each sensor. If the expected behavior (indicated in the tables below) does not occur, continue alignment of the sensors. Alternatively, confirm that the sensors are in adjustment mode, i.e., the side LED on the sensor electronics is lit up yellow.

Overall one has to test 8 cases, all of which have to work before starting the experiment:¹⁰

Alice	Bob	Which LED lights up	Bit
-45°	0°	Both	Random
0°	0°	Transmitted	0
45°	0°	Both	Random
90°	0°	Reflected	1

Alice	Bob	Which LED lights up	Bit
-45°	45°	Transmitted	0
0°	45°	Both	Random
45°	45°	Reflected	1
90°	45°	Both	Random

Once all cases are verified, set the sensor electronics to measuring mode (LED changes from yellow to green).

All eight cases must perform correctly, otherwise the experiment will not produce the correct results. Chapter 11 contains a troubleshooting guide for additional help with aligning the sensors and lasers.

Important: The setup should not be moved during the experiment. Leaning on the table may cause the laser and sensors to become misaligned.

¹⁰ The bit value has also been added to the table for assistance. Random events will cause both LEDs to light up if the sensor electronics are in adjustment mode. If the sensor electronics are in measuring mode, only one random LED will light up.

7.5. Adding Eve

To add Eve as an eavesdropper to the setup, place the large breadboard between the breadboards of Alice and Bob. In this scenario, Eve is intended to intercept transmissions from Alice to Bob, so avoid making changes to Alice and Bob and align Eve within the setup.

- Attach the BBH1 handles onto the breadboard of Eve. This makes it possible to add and remove Eve quickly.
- Install Eve's receiver. The setup is the same as aligning Bob's receiver described in Section 7.4. Test to verify that all 8 cases are aligned correctly. Then set the sensor electronics from adjustment mode back to measuring mode.
- Set up Eve's transmitter. Eve's transmitting laser should be aligned to hit each of Bob's sensors (depending on polarization). Use alignment mode on Eve's laser to aid alignment. Verify that all 8 transmission cases work between Eve's transmitter and Bob, and then switch Eve's laser back to measuring mode.
- The laser and sensor electronics box can be attached to the breadboard using a CL3/M clamp. This makes it easier to take out Eve. As shown in the photo to the right, each clamp utilizes two screws. The 1/4"-20 x 1.25" (M6 x 30 mm) cap screw to the far right adapts the clamp to the needed height, while the closer 1/4"-20 x 2" (M6 x 45 mm) cap screw secures the clamp to the breadboard.

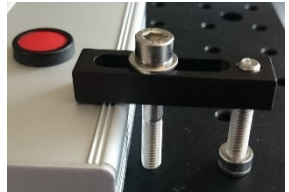

The finished setup of Eve looks as follows:

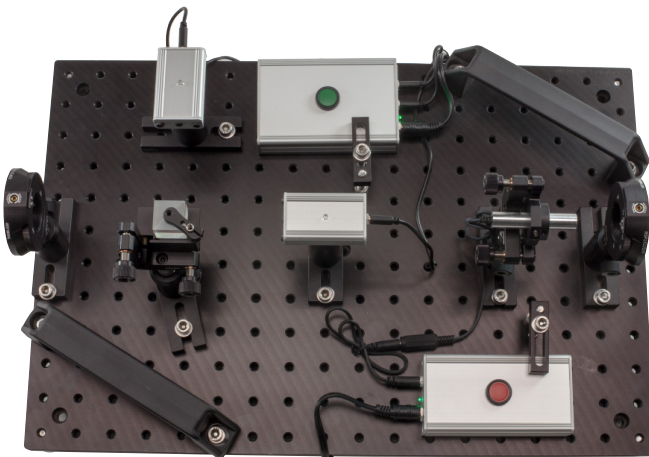

Figure 8 Eve

Chapter 8 Experiment

The experiment is divided into three sections:

- **Section 8.1:** Generating a key with a length of at least 20 bits
- **Section 8.2:** Encryption and transmission of a 4-letter word
- **Section 8.3:** Installation of Eve and detection of an eavesdropper

In order to complete the exercises, the user should be familiar with the encryption principles outlined in Chapter 5. Detailed examples are presented in Chapter 6, illustrating the entire process with and without Eve. A sample measurement protocol can be found in Chapter 9.

8.1. Key Generation

Exercise 1: Set up Alice and Bob so that they face each other at a large distance (leave enough space to place Eve between Alice and Bob). Using the guidelines in Chapter 7, align Alice and Bob so that all 8 transmission cases produce reproducible results. During this step, the sensor electronics should be in adjustment mode (the LED indicator is yellow).

Execution: See Chapter 7 for setup instructions. A basic schematic is shown in Figure 3 and a photo of the complete setup is shown in Figure 7. The possible transmission cases are outlined in Section 7.4.

Exercise 2: Alice and Bob randomly select their bases and Alice also selects random bits for transmission. Chapter 9 provides a 52-bit measuring protocol. Fill in the bits and bases that Alice will use to transmit her signal and the bases that Bob will use for detection.

Execution: This corresponds to step 1 in the example described in Section 6.1. The protocols can be found in Chapter 9.

Exercise 3: Transmit Alice's bits in the bases chosen in Exercise 2. Bob notes the bits he receives.

Execution: This corresponds to step 2 in the example described in Section 6.1. Alice and Bob have to generate a key that is at least 20 bits long. We recommend a transmission sequence of at least 52 bits for this purpose. Because of the random component in generating a key, a longer transmission is more likely to achieve the 20 matching bases for the encryption key. During this step, the sensor electronics should be in measurement mode (the LED indicator is green).

To summarize the choice of bases used in transmission, if Alice:

- Selects 0° then she sends a 0 in the "+" basis.
- Selects 90° then she sends a 1 in the "+" basis.
- Selects -45° then she sends a 0 in the "x" basis.
- Selects 45° then she sends a 1 in the "x" basis.

Alice and Bob transmit the bits according to the table prepared in Exercise 2. Alice sends her bit and Bob notes his measurement (reflected = 1, transmitted = 0).

Exercise 4: Alice and Bob publically exchange the bases used for each measurement. They then erase any measurements where the bases do not match. The remaining measurements/bits form the complete encryption key.

Execution: This corresponds to step 3 in the example detailed in Section 6.1. Alice and Bob exchange their bases (“I have chosen +” or “I have chosen x”) and mark any measurements with matching bases. The corresponding bits form the encryption key.

If 52 measurements are not enough to generate a 20 bit encryption key, then the transmission should be repeated with more measurements until a 20 bit key is generated.

8.2. Encryption and Transmission of a Four-Letter Word

Exercise 5: Encrypt Alice’s message (4 letters) using the key that was generated.

Execution: The procedure is described in step 4 of Section 6.1 and also in Section 5.2.

Exercise 6: Transmit the encrypted message from Alice to Bob.

Execution: Transmission of the actual message is done entirely in one basis. Alice sends her encrypted bits (0° for 0, 90° for 1). Alice and Bob do not change the basis for data transmission. This corresponds to steps 5a and 5b in Section 6.1.

Exercise 7: Decrypt the bits received by Bob to find Alice’s message.

Execution: This process is the same as described in Section 5.2 and corresponds to step 6 in Section 6.1.

8.3. Adding Eve and Detection of Eavesdropping

Exercise 8: Place Eve between Alice and Bob, and set both sensor electronics to adjustment mode (LED lights up yellow). Adjust Eve’s receiver so that all 8 transmission cases work with Alice. Then, adjust Eve’s transmitter so that all 8 transmission cases work with Bob. Return to measurement mode for both sensor electronics (LED lights up green).

Execution: The adjustment is performed as described in Chapter 7 (also see Figure 4 and Figure 8). The goal should be to align Eve without disturbing the setups for Alice and Bob, since the eavesdropper has no influence on the sender and receiver. Then set the sensor electronics to measurement mode.

Exercise 9: Fill out the table for Eve, which determines the random choice of the + or the x basis. Random bases are also needed Alice and Bob again, and random bits should be chosen by Alice for transmission.

Execution: There are two methods for implementing this step. In an ideal scenario where the users are isolated from each other, Eve could just choose a basis spontaneously and transmit the measured result. However, because users are in the same room, the physical act of changing a basis leads to a non-random bias for Eve's operator. Choosing random bases at the start of the sequence prevents this bias from interfering with the results of the experiment. A sample table of bases for Eve to use can be found in Chapter 9. Keep in mind that Eve's operator does not have to record any data.

An example is also provided in Step 1 of Section 6.2.

Exercise 10: Send Alice's first bit using the basis chosen in the previous exercise. Eve chooses her first basis (randomly chosen in Exercise 9). She receives a bit which she relays to Bob using the same basis. Bob records the bit he receives. This is performed for all 52 bits/bases in the sequence.

Execution: Alice and Bob use the same procedure as in Exercise 3. Eve receives the signal from Alice using the randomly chosen basis from Exercise 9. Then she transmits her measurement (using the same basis). This exercise corresponds to step 2 of Section 6.2.

Exercise 11: Alice and Bob publically exchange their bases for each measurement. They then erase the measurements in the sequence where the bases do not match.

Execution: Similar to Exercise 4, Alice and Bob compare their bases and eliminate bits where the bases used do not match. The remainder forms the bit sequence that is used to test for an eavesdropper. This exercise corresponds to step 3 in Section 6.2.

Exercise 12: Compare Alice's and Bob's results from exercise 11.

Execution: Because of Eve's eavesdropping and transmitting bits using a random basis (not necessarily identical to Alice), the bit sequences recorded by Alice and Bob should contain errors (bits that do not match). The presence of these errors is what allows Alice and Bob to detect the presence of an eavesdropper. This is different than the result from Exercise 4 where Alice and Bob should obtain the same result. This exercise corresponds to step 4 in Section 6.2.

Chapter 9 Measuring Protocols

This section contains the measuring protocols for Alice, Bob and Eve.

In order to make them easy to print, each of them is on one page (the manual is also available as a free download at discovery.thorlabs.com).

Then you find the table with the encoding of the alphabet using 5 bits per letter.

Measuring protocol for key generation – ALICE

	1	2	3	4	5	6	7	8	9	10	11	12	13	14	15	16	17	18
Basis (+ or x)																		
Bit (0 or 1)																		

	19	20	21	22	23	24	25	26	27	28	29	30	31	32	33	34	35	36
Basis (+ or x)																		
Bit (0 or 1)																		

	37	38	39	40	41	42	43	44	45	46	47	48	49	50	51	52
Basis (+ or x)																
Bit (0 or 1)																

Generated Key:

Angle setting (remainder)	Basis +	Basis x
Bit 0	0°	-45°
Bit 1	90°	45°

Table for encryption of the message – Alice

Letter																		
Data Bit																		
Key Bit																		
Encrypted Bit																		

Data Bit = letter in binary form, 4 x 5 Bit



Measuring protocol for key generation – BOB

	1	2	3	4	5	6	7	8	9	10	11	12	13	14	15	16	17	18
Basis (+ or x)																		
Bit (0 or 1)																		

	19	20	21	22	23	24	25	26	27	28	29	30	31	32	33	34	35	36
Basis (+ or x)																		
Bit (0 or 1)																		

	37	38	39	40	41	42	43	44	45	46	47	48	49	50	51	52
Basis (+ or x)																
Bit (0 or 1)																

Generated Key:

Reminder	transmitted	reflected
Basis + (=0°)	0	1
Basis x (=45°)	0	1

Table for decryption of the message – BOB

Received Bit																		
Key Bit																		
Data Bit																		
Letter																		



Basis selection – EVE

	1	2	3	4	5	6	7	8	9	10	11	12	13	14	15	16	17	18
Basis (+ or x)																		

	19	20	21	22	23	24	25	26	27	28	29	30	31	32	33	34	35	36
Basis (+ or x)																		

	37	38	39	40	41	42	43	44	45	46	47	48	49	50	51	52
Basis (+ or x)																

Binary representation of the alphabet

A	0	0	0	0	0
B	0	0	0	0	1
C	0	0	0	1	0
D	0	0	0	1	1
E	0	0	1	0	0
F	0	0	1	0	1
G	0	0	1	1	0
H	0	0	1	1	1
I	0	1	0	0	0
J	0	1	0	0	1
K	0	1	0	1	0
L	0	1	0	1	1
M	0	1	1	0	0
N	0	1	1	0	1
O	0	1	1	1	0
P	0	1	1	1	1
Q	1	0	0	0	0
R	1	0	0	0	1
S	1	0	0	1	0
T	1	0	0	1	1
U	1	0	1	0	0
V	1	0	1	0	1
W	1	0	1	1	0
X	1	0	1	1	1
Y	1	1	0	0	0
Z	1	1	0	0	1

Binary Addition Table

0	1	0	1
+ 0	+ 0	+ 1	+ 1
= 0	= 1	= 1	= 0

Chapter 10 Teaching Tips

- The generation of random numbers is a fundamental problem in quantum cryptography. When the selection of bases and bits in the experiment is performed with human-generated random numbers, Alice and Bob may have a lot of matches because a human is a poor random number generator. This can be easily shown using a simple exercise:
 - Have the students create what they consider a random sequence of 0 and 1 bits
 - Write a program that analyzes the number and length of any chains in their sequence using the bit 1. For example, the sequence 01110 would be a single chain of 1s that is 3 bits long. The program should count the number of sequence chains with length n that occur in the student's sequences. The probability (measured in number of occurrences) should decrease with $1/2^n$ for a true random sequence.
 - However, when the sequence is chosen by a human, biases will enter into the selection process. Students will rarely write sequences with a chain of 1s (or 0s) that has a length longer than 5 because such a sequence does not appear to be random. However, given enough samples, such sequences do occur if randomly chosen (though with lower probability). Plotting the student-chosen sequences against the theoretical curve should quickly show the deviation from true random selection.
- Exercise 2 in Chapter 8 instructs the students to produce a random selection of bases for Alice and Bob, and also the random selection of bits for Alice. The point above illustrates how human biases make them a poor choice for a random number generator.

Alternatively, a device that can produce randomly chosen bits would produce better results. Examples of these include commercial devices such as the Quantis from ID Quantique or a device comprised of a light source, two single photon detectors and a beamsplitter.

One simple solution is to use a transparent box with several dice. Even number results from rolling the dice are interpreted as a 0-bit while odd number results are interpreted as a 1-bit. Coin toss or a pseudo-random numbers generated by a computer program also provide low-cost alternatives.

- The exercises described in Chapter 8 are structured so that the students initially set up Alice and Bob, generate a key, and then transmit a message. After the initial transmission, Eve is added and discovered during the generation of a second key. This process does not correspond exactly to the BB84 protocol presented in Section 5.7. In the BB84 protocol, the test for an eavesdropper is performed prior to transmitting the message. The key generation and data transmission is a good starting point, though, for students encountering the material for the first time.

Chapter 11 Troubleshooting

- When running through the 8 combinations of the $\lambda/2$ plates of Alice and Bob (or Alice and Eve, Eve and Bob), not all 8 cases work.
 - Are both sensor electronics boxes set to the adjustment mode? This is indicated by the LED on the side emitting yellow light. If it is green, press the green button to switch to adjustment mode. The measurement mode is indicated by green light coming from the LED.
 - Are all $\lambda/2$ plates installed correctly in the RSP1X225/M holder? The “fast axis” has to line up with the “0°” mark. Furthermore the snap mechanism of the holder (loosen and secure with the screw on the top of the holder) has to be secured at 0°.
 - Is the laser properly inserted so its polarization axis is correct? Check again that the transmission of the laser is minimal when it first passes through a $\lambda/2$ plate with 0° setting, then a $\lambda/2$ plate with 90° setting (“90°” with the special scale! For this the holder itself is only rotated by 45° increments) and then through the beamsplitter.
 - Is the orientation of the beamsplitter correct? Compare with photos in section 7.1.
 - Do the $\lambda/2$ plates of Alice and Bob (or Alice and Eve, Eve and Bob) face away from each other? Does the $\lambda/2$ plate of Alice face the laser?
 - Is everything set up as perpendicular as possible? Is the sensor perpendicular to the incident laser beam, is the lens installed straight, is the sensor for the reflected beam at 90° to the incident beam? Examining the setup from above is often helpful here.
 - Are both sensors the same distance away from the beamsplitter? Sometimes varying the distance of the sensors/photodiodes from the beamsplitter helps. For example, one can move both sensors closer to the beamsplitter.
 - Are you sure that the photodiodes are properly lined up? Just because the laser passes approximately through the sensor opening, this does not mean an optimum hit on the photodiode
 - If alignment of the laser and sensors continues to fail, look into the opening of the sensor module. Verify that the photodiode is behind the opening and centered within the hole. If the photodiode is off center, adjust the alignment of the laser to point to the photodiode center instead.

Chapter 12 Acknowledgements

This experiment package was developed in close cooperation with various lecturers dedicated to the teaching of quantum physics. We would like to express our sincere appreciation to:

- OStR Jörn Schneider, Leibniz-Gymnasium Dormagen, for the joint implementation of the experiment, the electronics and sensors, testing in the course of instruction and sharing his teaching documents.
- Andreas Vetter and Prof. Dr. Jan-Peter Meyn, University Erlangen-Nuremberg, for their preliminary conceptual work. The two of them built a setup with a pulsed source and corresponding detectors, and operated it in their student laboratory. See A. Vetter, A. Strunz, P. Bronner and J.-P. Meyn: "Photonik macht Schule - Ein Schülerlabor zur modernen Optik und Quantenoptik." Praxis der Naturwissenschaften – Physik in der Schule 59(8) 17-19 (2010).

On the topic of quantum physics, we recommend in particular Jan-Peter Meyn's website www.quantumlab.de which also served as inspiration for parts of the preceding instructions.

- Heisenberg-Gesellschaft e.V, Munich, at whose workshop "Quantum Physics in School 2014" the contact was established.
- Jasmin Karim, Karlsruhe Institute of Technology, for her draft of the experiment's quantum mechanical description in Dirac notation.

Do you also have ideas for an experiment which you either have implemented already or want to implement? Please contact us, we are happy to enter into partnerships!

Chapter 13 Regulatory

As required by the WEEE (Waste Electrical and Electronic Equipment Directive) of the European Community and the corresponding national laws, Thorlabs offers all end users in the EC the possibility to return “end of life” units without incurring disposal charges.

- This offer is valid for Thorlabs electrical and electronic equipment:
- Sold after August 13, 2005
- Marked correspondingly with the crossed out “wheelie bin” logo (see right)
- Sold to a company or institute within the EC
- Currently owned by a company or institute within the EC
- Still complete, not disassembled and not contaminated



As the WEEE directive applies to self-contained operational electrical and electronic products, this end of life take back service does not refer to other Thorlabs products, such as:

- Pure OEM products, that means assemblies to be built into a unit by the user (e.g. OEM laser driver cards)
- Components
- Mechanics and optics
- Left over parts of units disassembled by the user (PCB's, housings etc.).

If you wish to return a Thorlabs unit for waste recovery, please contact Thorlabs or your nearest dealer for further information.

13.1. Waste Treatment is Your Own Responsibility

If you do not return an “end of life” unit to Thorlabs, you must hand it to a company specialized in waste recovery. Do not dispose of the unit in a litter bin or at a public waste disposal site.

13.2. Ecological Background

It is well known that WEEE pollutes the environment by releasing toxic products during decomposition. The aim of the European RoHS directive is to reduce the content of toxic substances in electronic products in the future.

The intent of the WEEE directive is to enforce the recycling of WEEE. A controlled recycling of end of life products will thereby avoid negative impacts on the environment.

Chapter 14 Thorlabs Worldwide Contacts

USA, Canada, and South America

Thorlabs, Inc.
56 Sparta Avenue
Newton, NJ 07860
USA
Tel: 973-300-3000
Fax: 973-300-3600
www.thorlabs.com
www.thorlabs.us (West Coast)
Email: sales@thorlabs.com
Support: techsupport@thorlabs.com

UK and Ireland

Thorlabs Ltd.
1 Saint Thomas Place
Ely CB7 4EX
Great Britain
Tel: +44 (0) 1353-654440
Fax: +44 (0) 1353-654444
www.thorlabs.com
Email: sales.uk@thorlabs.com
Support: techsupport.uk@thorlabs.com

Europe

Thorlabs GmbH
Hans-Böckler-Str. 6
85221 Dachau / Munich
Germany
Tel: +49-(0) 8131-5956-0
Fax: +49-(0) 8131-5956-99
www.thorlabs.de
Email: europe@thorlabs.com

Scandinavia

Thorlabs Sweden AB
Bergfotsgatan 7
431 35 Mölndal
Sweden
Tel: +46-31-733-30-00
Fax: +46-31-703-40-45
www.thorlabs.com
Email: scandinavia@thorlabs.com

France

Thorlabs SAS
109, rue des Côtes
78600 Maisons-Laffitte
France
Tel: +33 (0) 970 444 844
Fax: +33 (0) 825 744 800
www.thorlabs.com
Email: sales.fr@thorlabs.com

Brazil

Thorlabs Vendas de Fotônicos Ltda.
Rua Riachuelo, 171
São Carlos, SP 13560-110
Brazil
Tel: +55-16-3413 7062
Fax: +55-16-3413 7064
www.thorlabs.com
Email: brasil@thorlabs.com

Japan

Thorlabs Japan, Inc.
3-6-3 Kitamachi,
Nerima-ku, Tokyo 179-0081
Japan
Tel: +81-3-6915-7701
Fax: +81-3-6915-7716
www.thorlabs.co.jp
Email: sales@thorlabs.jp

China

Thorlabs China
Room A101, No. 100 Lane 2891
South Qilianshan Road
Putuo District
Shanghai
China
Tel: +86 (0) 21-60561122
Fax: +86 (0) 21-32513480
www.thorlabschina.cn
Email: chinasales@thorlabs.com



THORLABS
www.thorlabs.com
