

# Quantum optics and qubits

# Single photon is beautiful, but we expect from it some practical application

- Thermal radiation
  - All hot objects emit light
  - Emission spectrum can be measured
  - Classical physics predicts infinite intensity

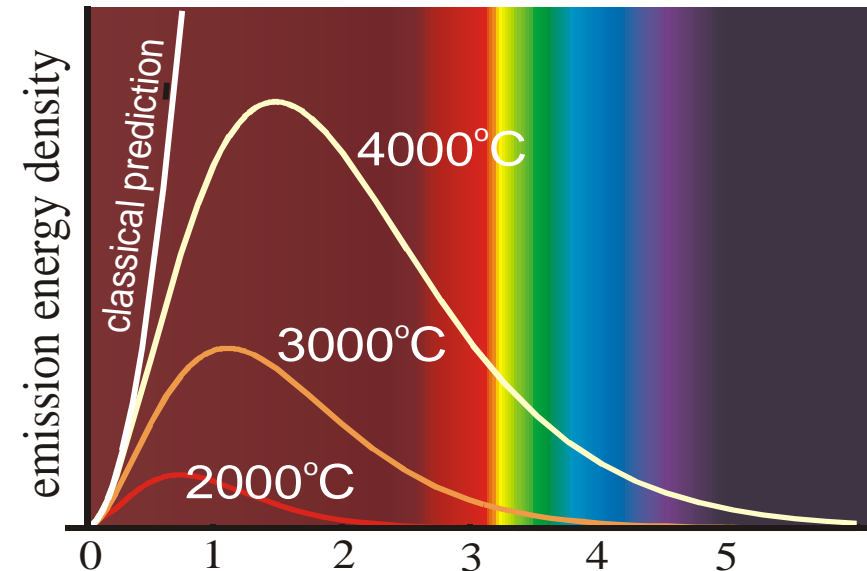
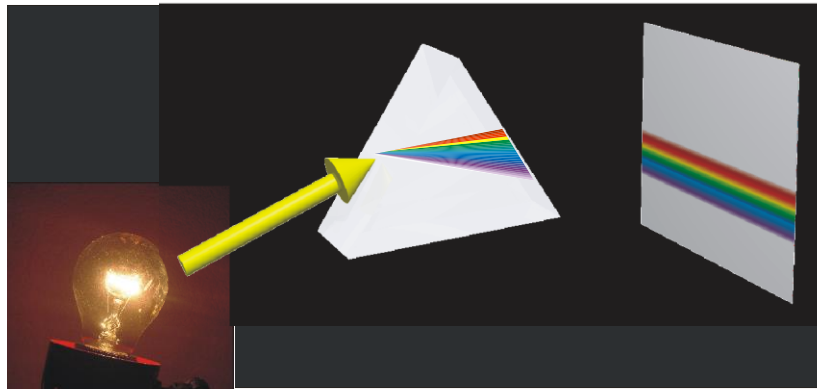
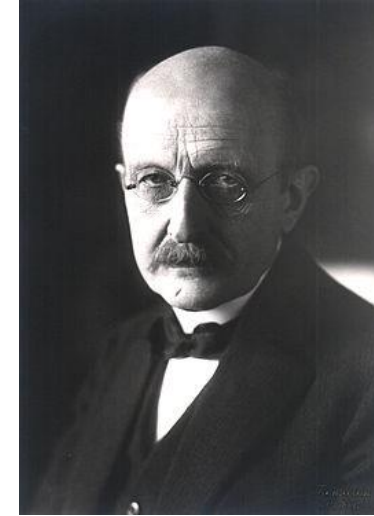

# Remind few words about light and states

Plain wave:

$$\vec{E}(\vec{r}, t) = \vec{E}_0 e^{i\vec{k}\vec{r} - i\omega t} + c.c.$$

# Remind few words about light and states

Plain wave:

$$\vec{E}(\vec{r}, t) = \vec{E}_0 e^{i\vec{k}\vec{r} - i\omega t} + c.c.$$

Combination of plain waves makes slowly-varying envelope :

*A. I. Lvovsky. Nonlinear and Quantum Optics*

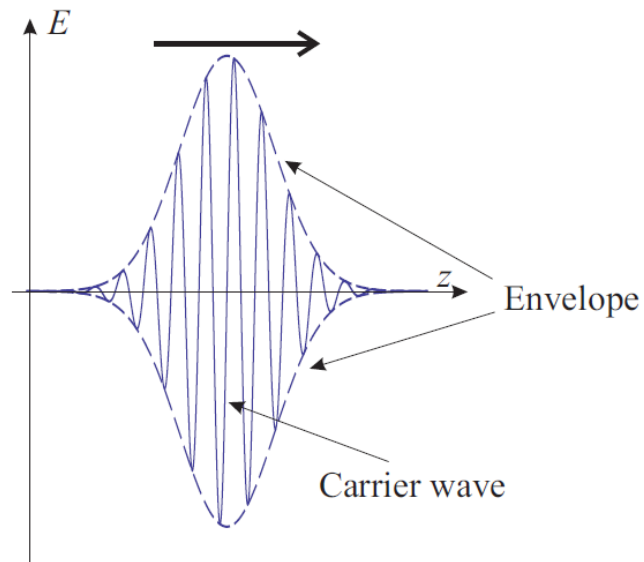

Figure 1.1: A pulse with a slowly varying envelope.

# Remind few words about light and states

Plain wave:

$$\vec{E}(\vec{r}, t) = \vec{E}_0 e^{i\vec{k}\vec{r} - i\omega t} + c.c.$$

Combination of plain waves makes slowly-varying envelope :

*A. I. Lvovsky. Nonlinear and Quantum Optics*

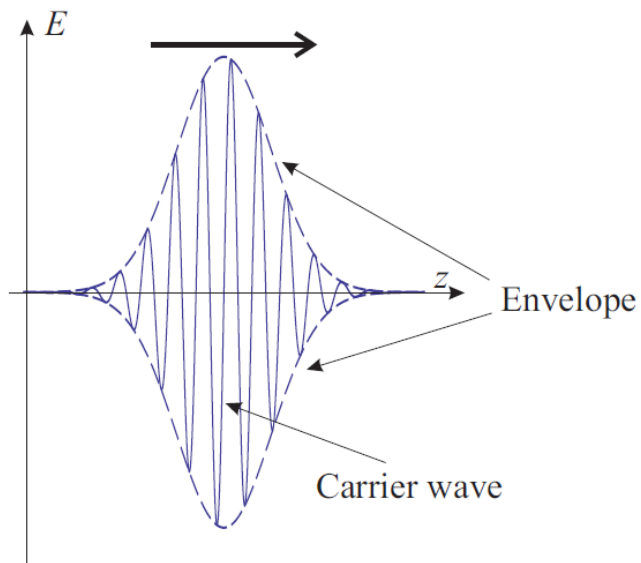
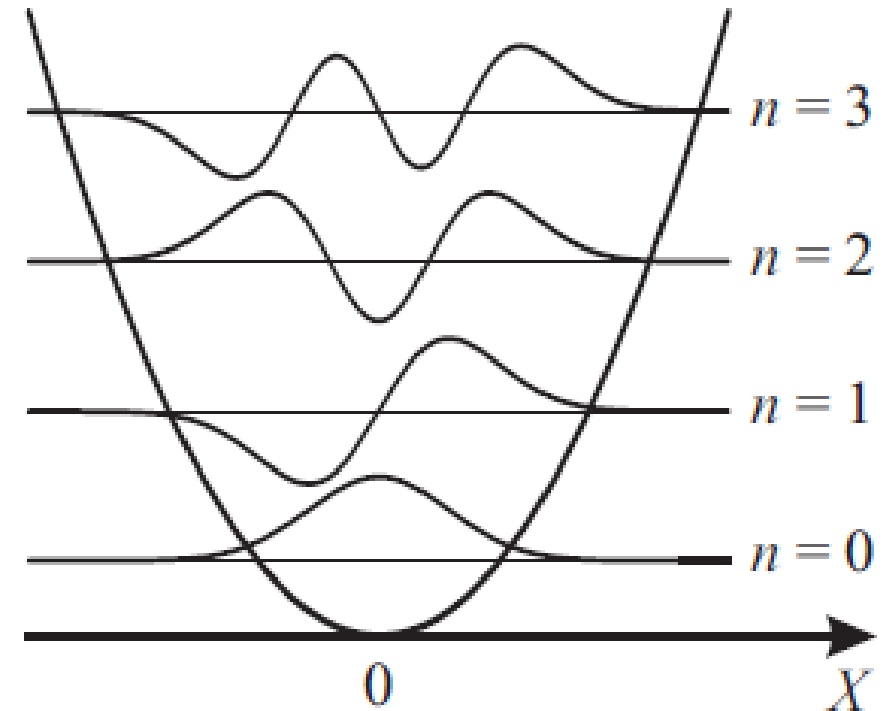

Figure 1.1: A pulse with a slowly varying envelope.

At the same time light can be quantized:



# Single-Photons are Elementary Particles

- Semi-transparent mirror

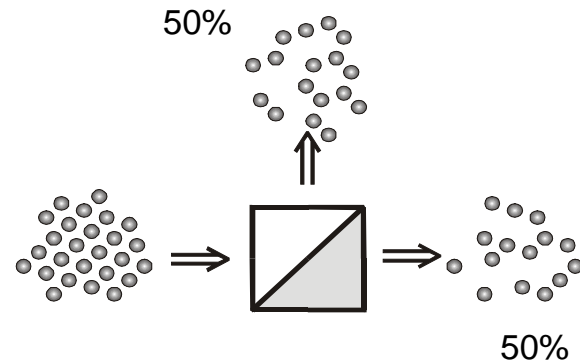

What is the “shape” of the photon?

# Single-Photons are Elementary Particles

- Semi-transparent mirror

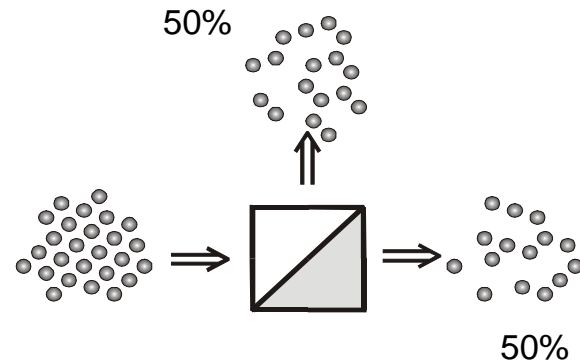

*It cannot be split*

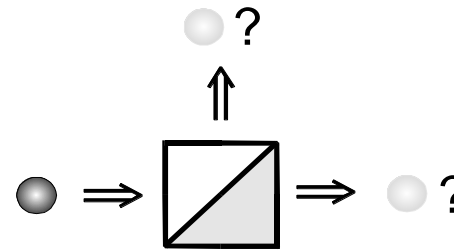

What is the “shape” of the photon?

# States of light

Vacuum state

$|0\rangle$

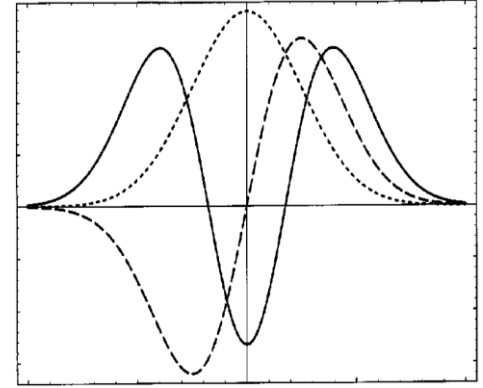



# States of light

Fock state:

$|n\rangle$  - defined number of photons

What about  $\Delta E \Delta t$  ???

$$|n\rangle = \frac{(\hat{a}^\dagger)^n}{\sqrt{n!}} |0\rangle$$

$$\hat{a}^\dagger |n\rangle = \sqrt{n+1} |n+1\rangle;$$

$$\hat{a} |n\rangle = \sqrt{n} |n-1\rangle;$$

$$\hat{n} = \hat{a}^\dagger \hat{a}$$

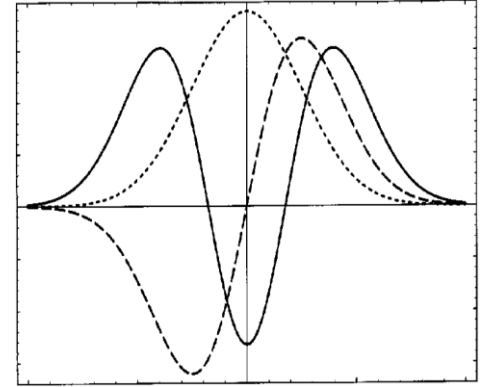

# States of light

Fock state:

$|n\rangle$  - defined number of photons

What about  $\Delta E \Delta t$  ???

$$|n\rangle = \frac{(\hat{a}^\dagger)^n}{\sqrt{n!}} |0\rangle$$

$$\hat{a}^\dagger |n\rangle = \sqrt{n+1} |n+1\rangle;$$

$$\hat{a} |n\rangle = \sqrt{n} |n-1\rangle;$$

$$\hat{n} = \hat{a}^\dagger \hat{a}$$

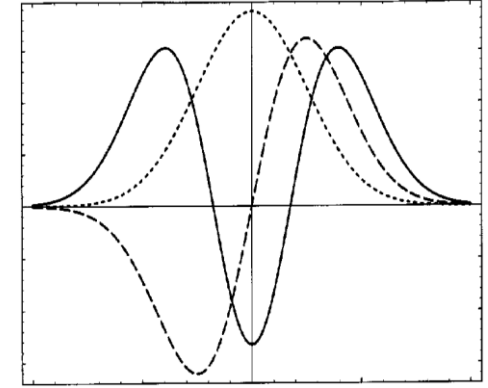

Coherent state:  $|\alpha\rangle$

$$|\alpha\rangle = e^{-|\alpha|^2/2} \sum_n \frac{\alpha^n}{\sqrt{n!}} |n\rangle$$

$$\hat{a} |\alpha\rangle = ?$$

$$\langle n | \alpha \rangle = ?$$

A. I. Lvovsky. *Nonlinear and Quantum Optics*

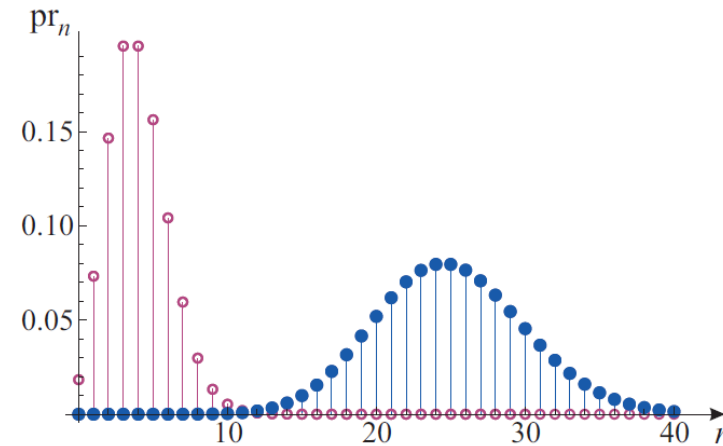

the Poisson distribution with  $\langle n \rangle = 4$  (empty circles) and  $\langle n \rangle = 25$  (filled circles).

# How to observe $\langle n \rangle$ ?

Threshold detector clicks on 1+ photons, we can put many of them

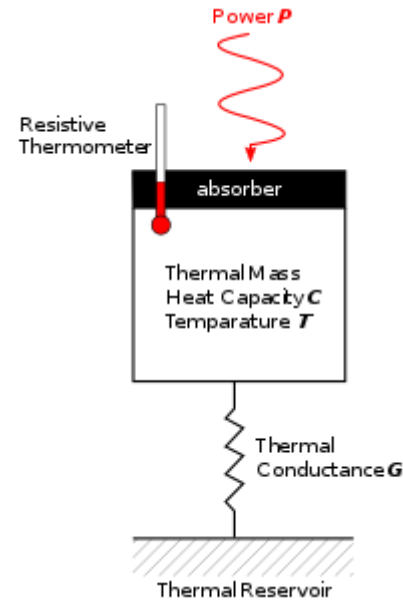

Superconducting nanowire bolometers can distinguish number of photons

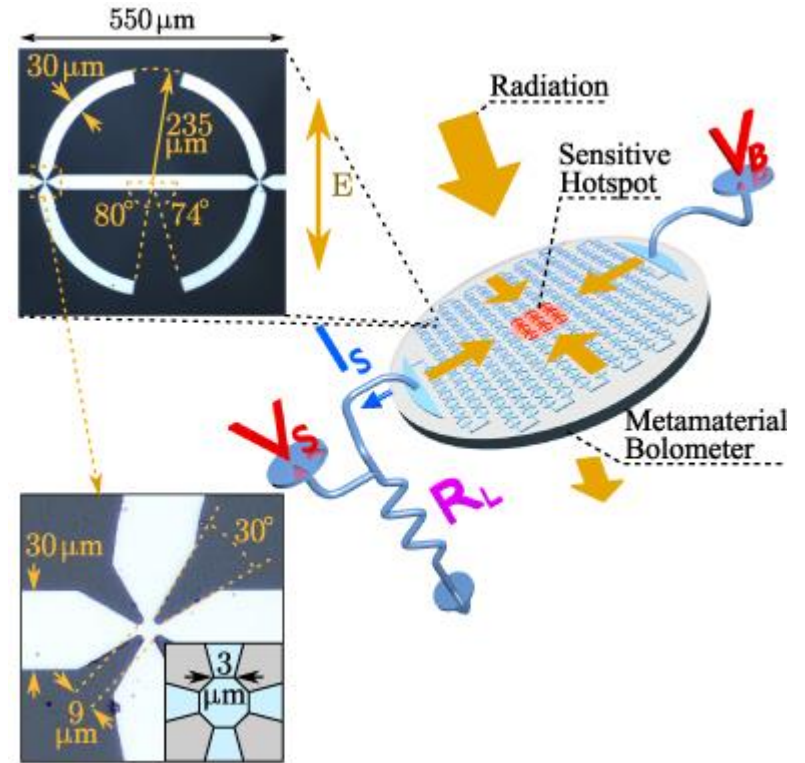

# How do we implement annihilation operator in the real experiment?

## Homework

- How to realize annihilation operator
- Can it be deterministic?

# Beamsplitter

$$\begin{pmatrix} E_{01}'^{(+)} \\ E_{02}'^{(+)} \end{pmatrix} = \underline{B} \begin{pmatrix} E_{01}^{(+)} \\ E_{02}^{(+)} \end{pmatrix},$$

$$\underline{B} = \begin{pmatrix} B_{11} & B_{12} \\ B_{21} & B_{22} \end{pmatrix}$$

$$\underline{B} = \begin{pmatrix} t & -r \\ r & t \end{pmatrix},$$

$$\begin{pmatrix} \hat{a}'_1 \\ \hat{a}'_2 \end{pmatrix} = \underline{B} \begin{pmatrix} \hat{a}_1 \\ \hat{a}_2 \end{pmatrix}.$$

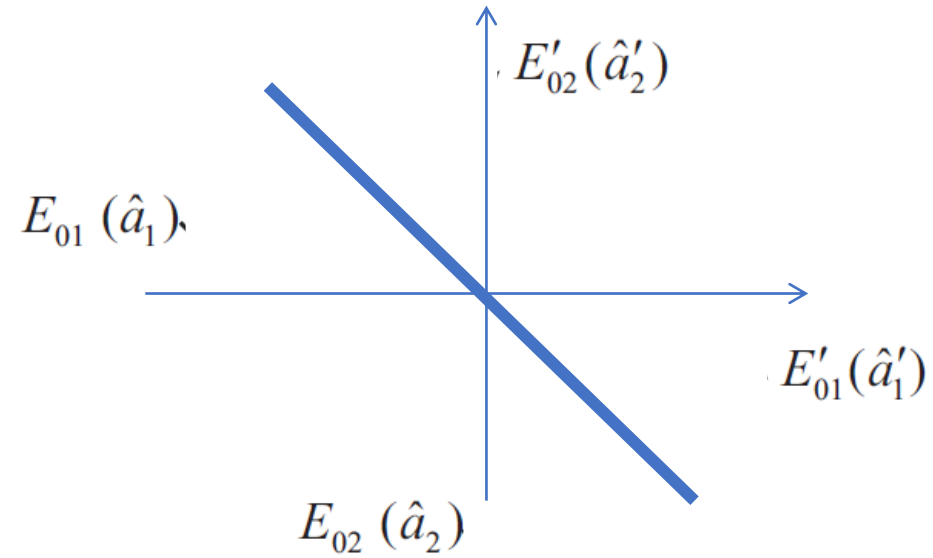

How does nature decides where is +r and where -r ?

Beamsplitter represents an absorption:

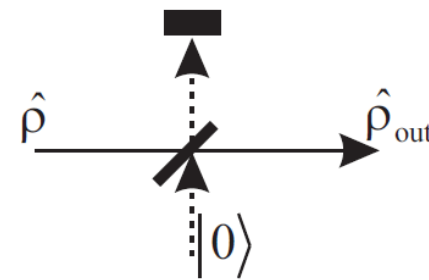

# The “bomb” paradox

[A. Elitzur and L. Vaidman (1993)]

- Mach-Zehnder interferometer tuned to get all signal on A

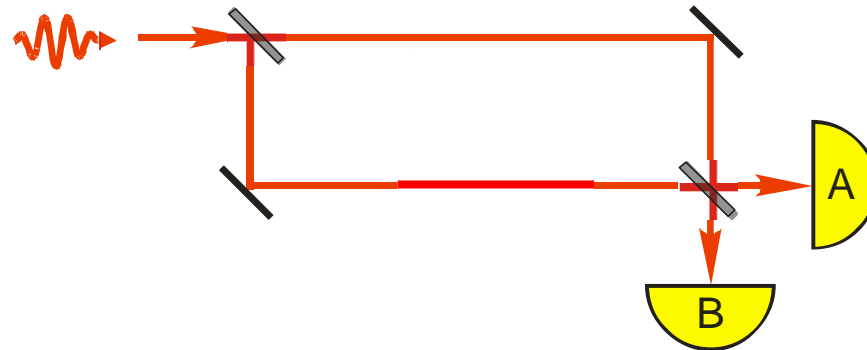

- If we move to single photon signal all clicks will still be on A

# The “bomb” paradox

[A. Elitzur and L. Vaidman (1993)]

- Mach-Zehnder interferometer tuned to get all signal on A

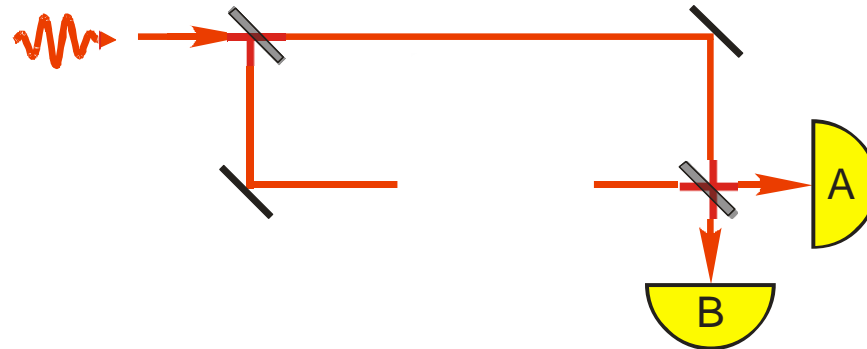

- If cut one arm the signal will be split 50/50

- *Single photon will click random detector*

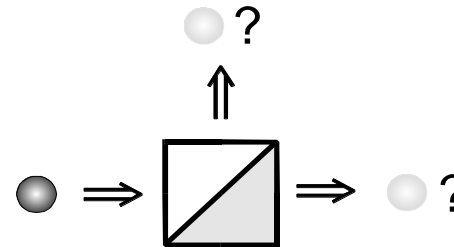

# The “bomb” paradox

[A. Elitzur and L. Vaidman (1993)]

- Interaction-free weapons inspection

- Insert a single-photon sensitive bomb into one of the interferometer arms

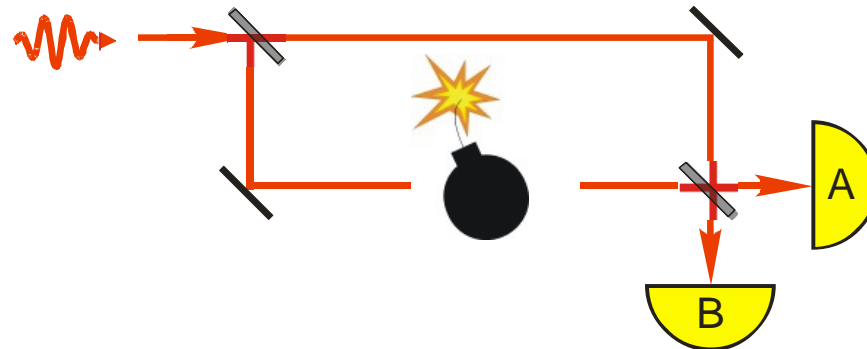

- Bomb absent  
→ **interference observed: all photons emerge at A**
- Bomb present  
→ **no interference: photons emerge at A or B**  
→ **bomb may or may not explode**
- Photon detected at B (what probability ?)  
→ **bomb is present**  
→ *bomb has been detected without any interaction!*



# Phase of the state

Fock state:

$|n\rangle$  - defined number of photons

$$|n\rangle = \frac{(\hat{a}^\dagger)^n}{\sqrt{n!}} |0\rangle$$

Coherent state:  $|\alpha\rangle$

$$|\alpha\rangle = e^{-|\alpha|^2/2} \sum_n \frac{\alpha^n}{\sqrt{n!}} |n\rangle$$

# Global phase of the state

Fock state:

$|n\rangle$  - defined number of photons

$$|n\rangle = \frac{(\hat{a}^\dagger)^n}{\sqrt{n!}} |0\rangle$$

**NO**

Coherent state:  $|\alpha\rangle$

$$|\alpha\rangle = e^{-|\alpha|^2/2} \sum_n \frac{\alpha^n}{\sqrt{n!}} |n\rangle$$

**YES**

# Hong-Ou-Mandel effect

(a)

fully distinguishable particles

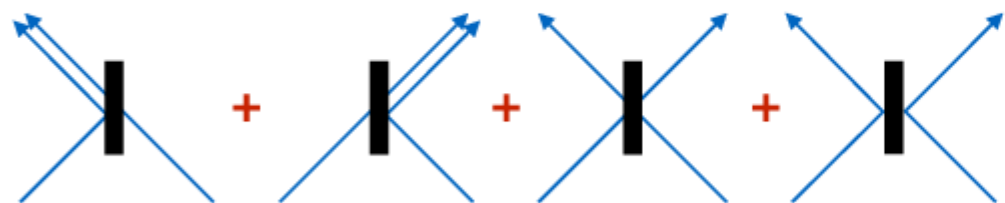

(b)

indistinguishable particles

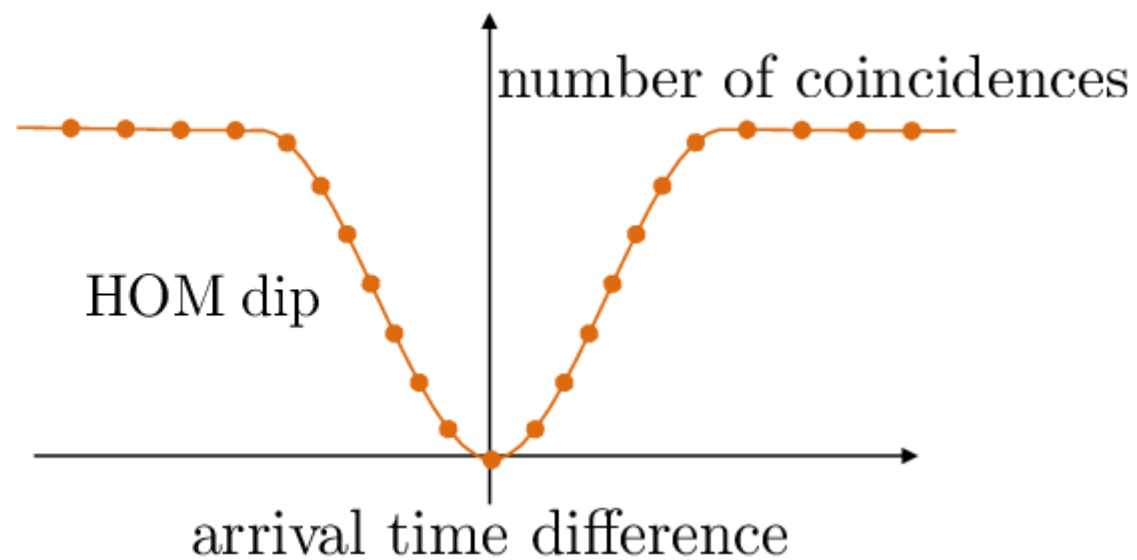
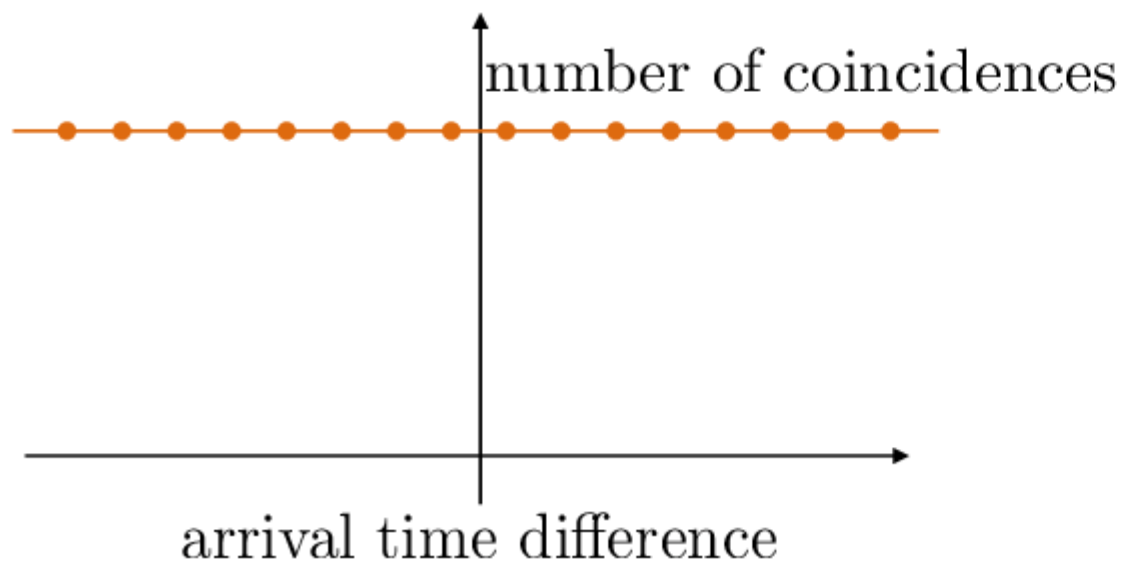
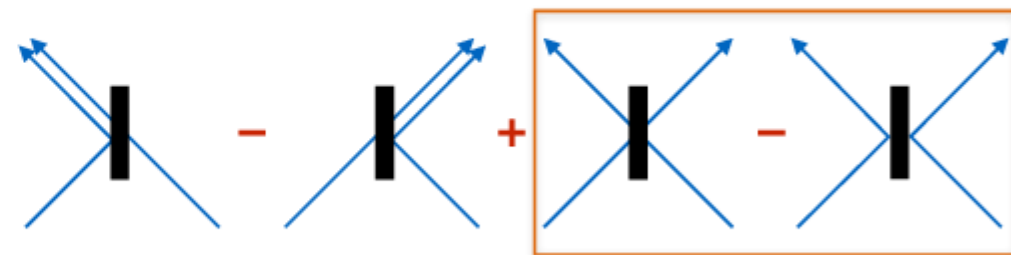

$$a|0\rangle + b|1\rangle$$



Qubit

# Optical implementations of a qubit

- **Single-rail qubit**

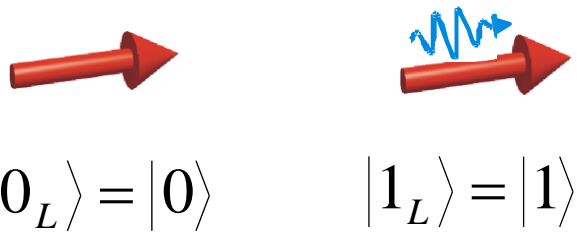

- **Dual-rail qubit**

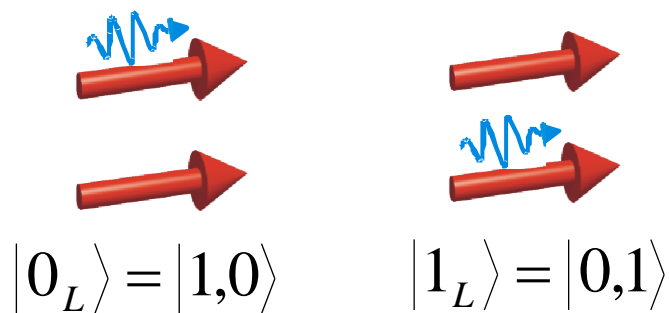

Polarizing beam splitter

- **Polarization qubit great for BB84 protocol**

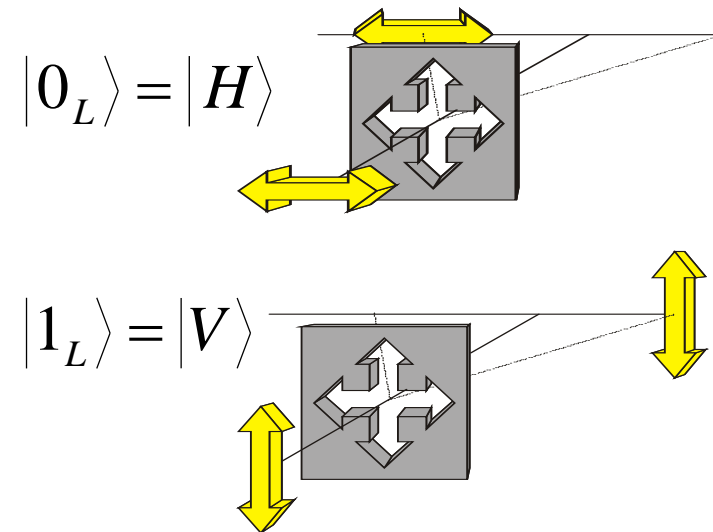

## CV qubits

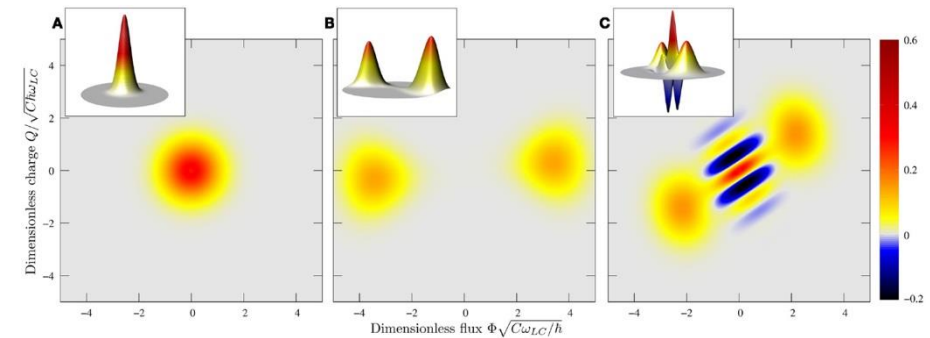

What methods of encoding you can propose?  
Can we encode more than one bit?





**€3 bn**



**\$20 bn**



**\$12 bn**



**\$400 m**



**\$150 m**



**\$100 m**



**\$75 m**



**\$50 m**

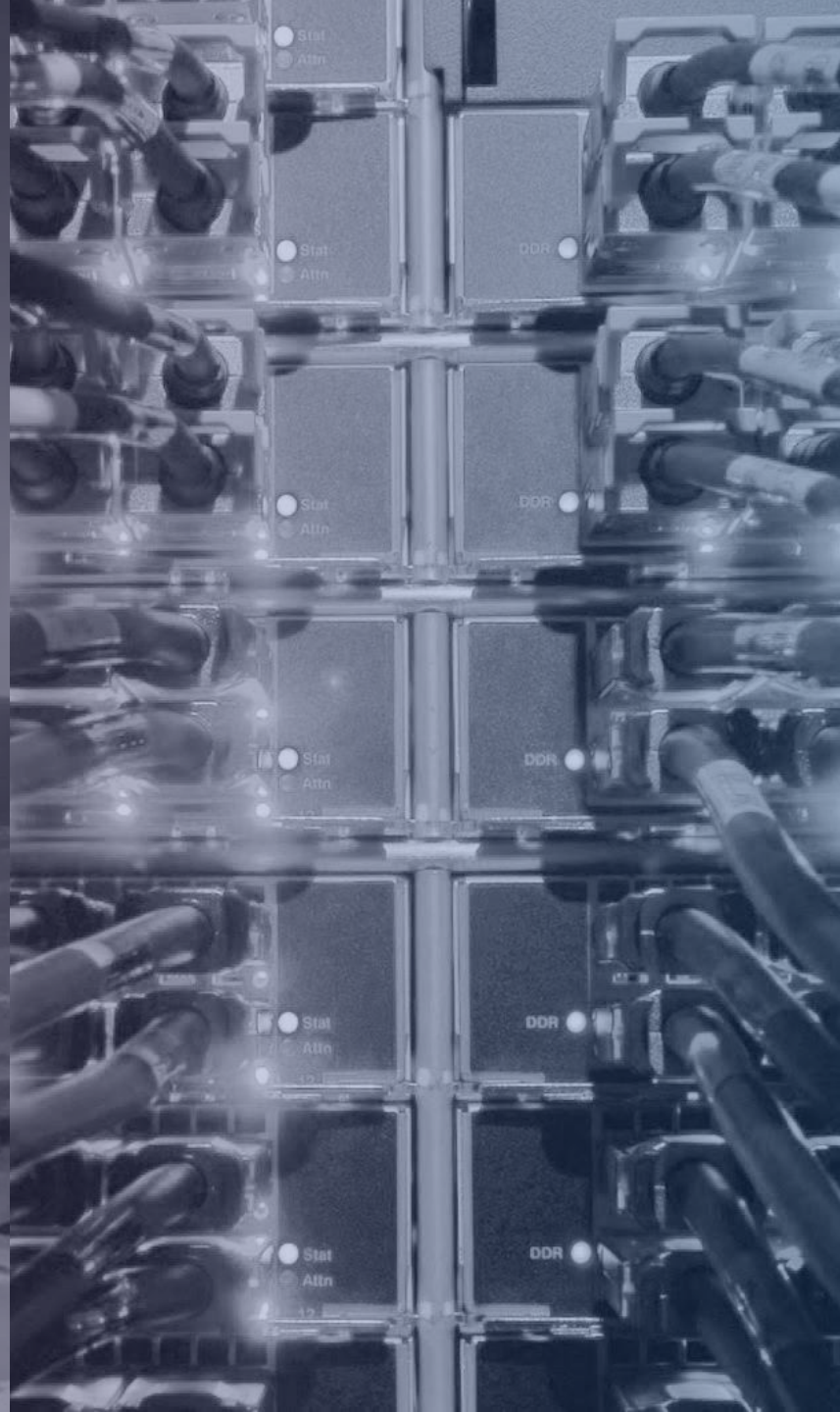

# States vizualization

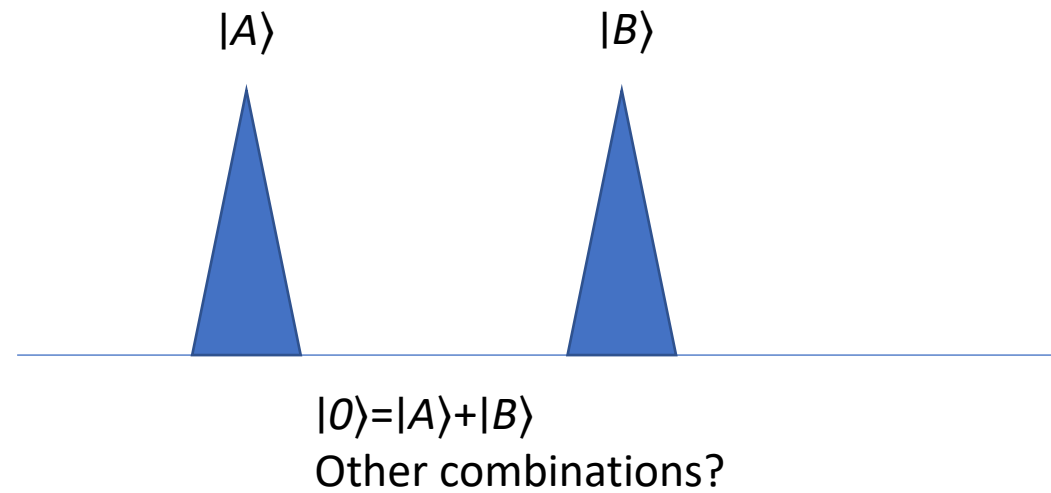
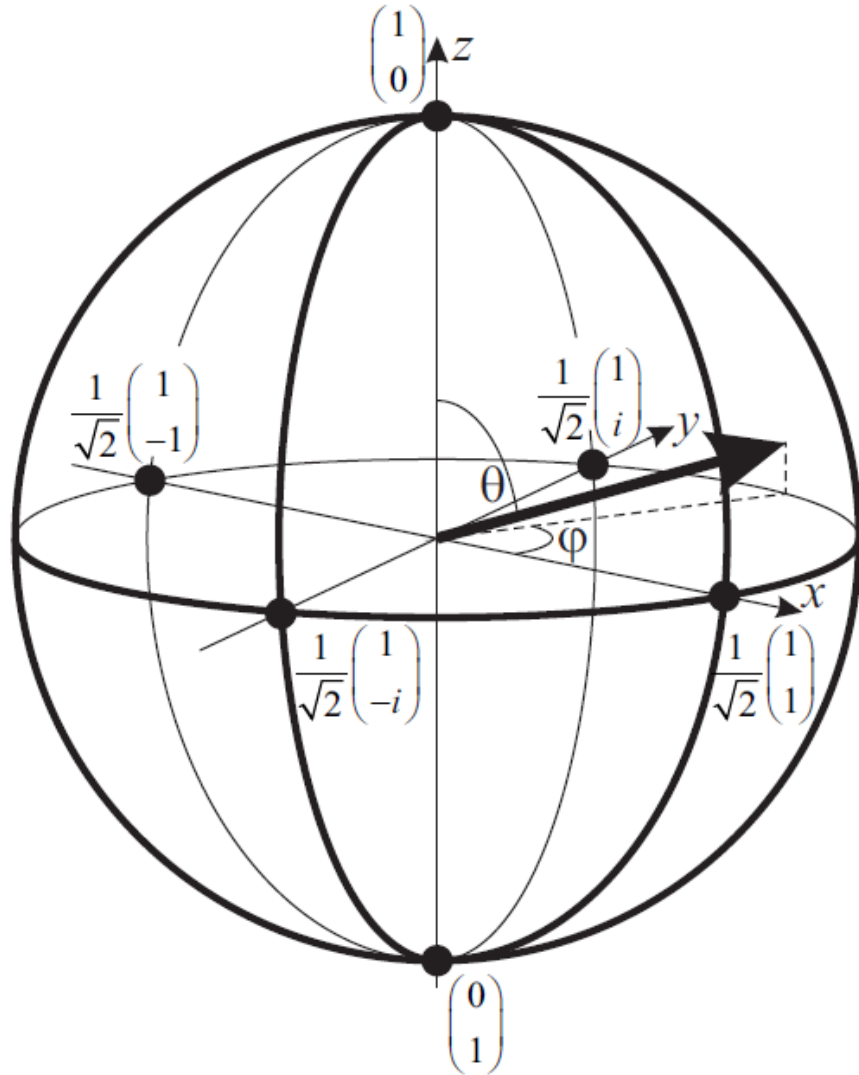

Figure 6.3: The Bloch sphere.



# States vizualization

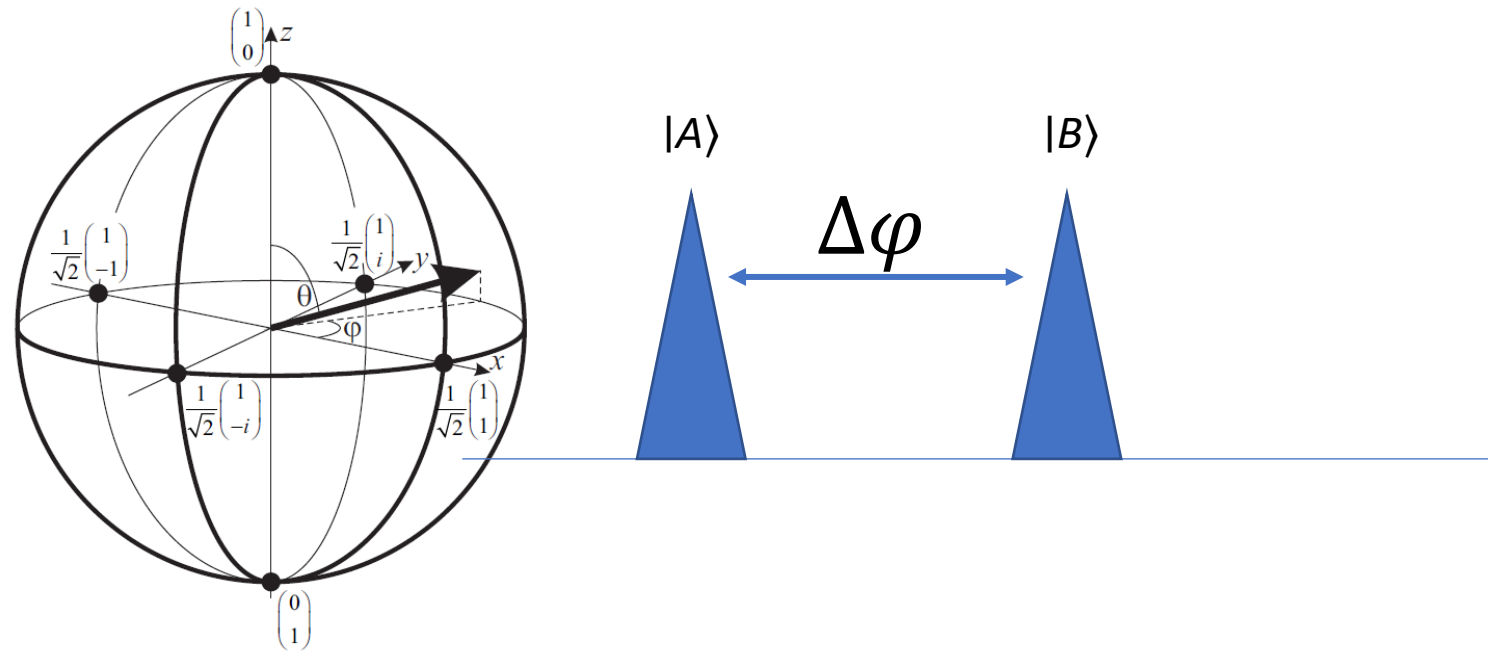

Figure 6.3: The Bloch sphere.

# States visualization

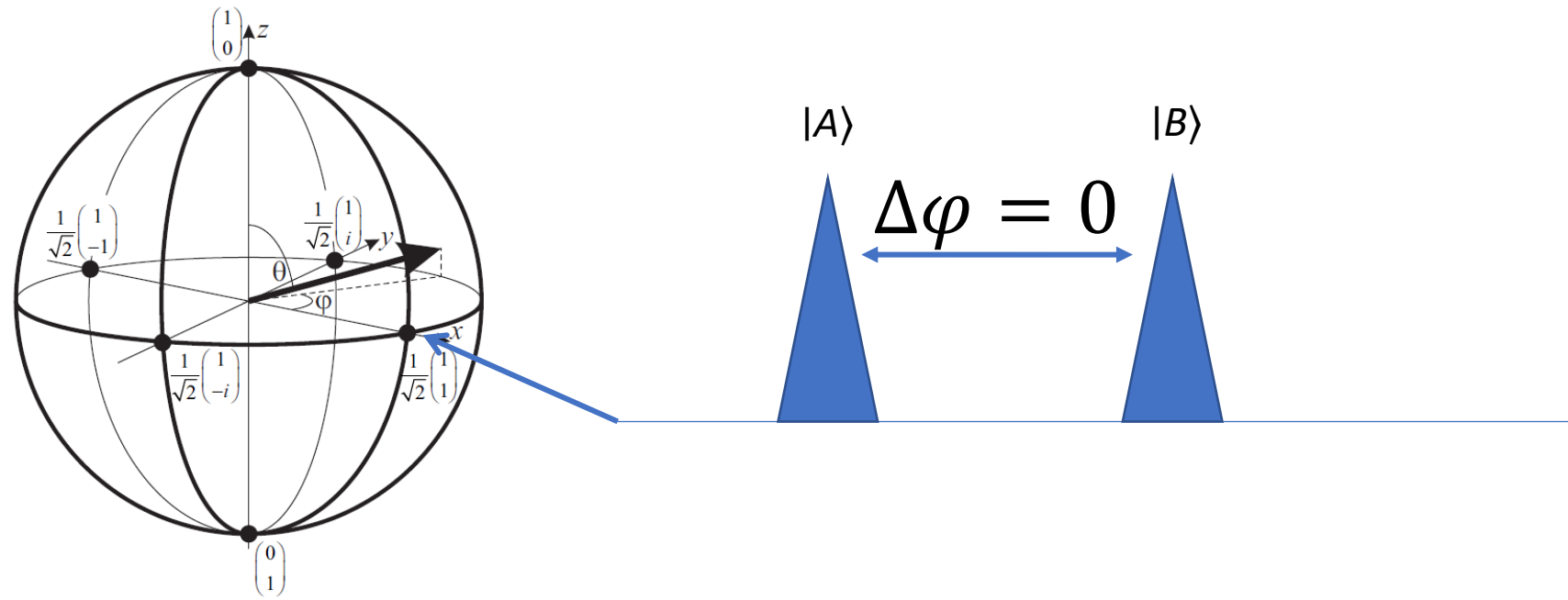

Figure 6.3: The Bloch sphere.

# States visualization

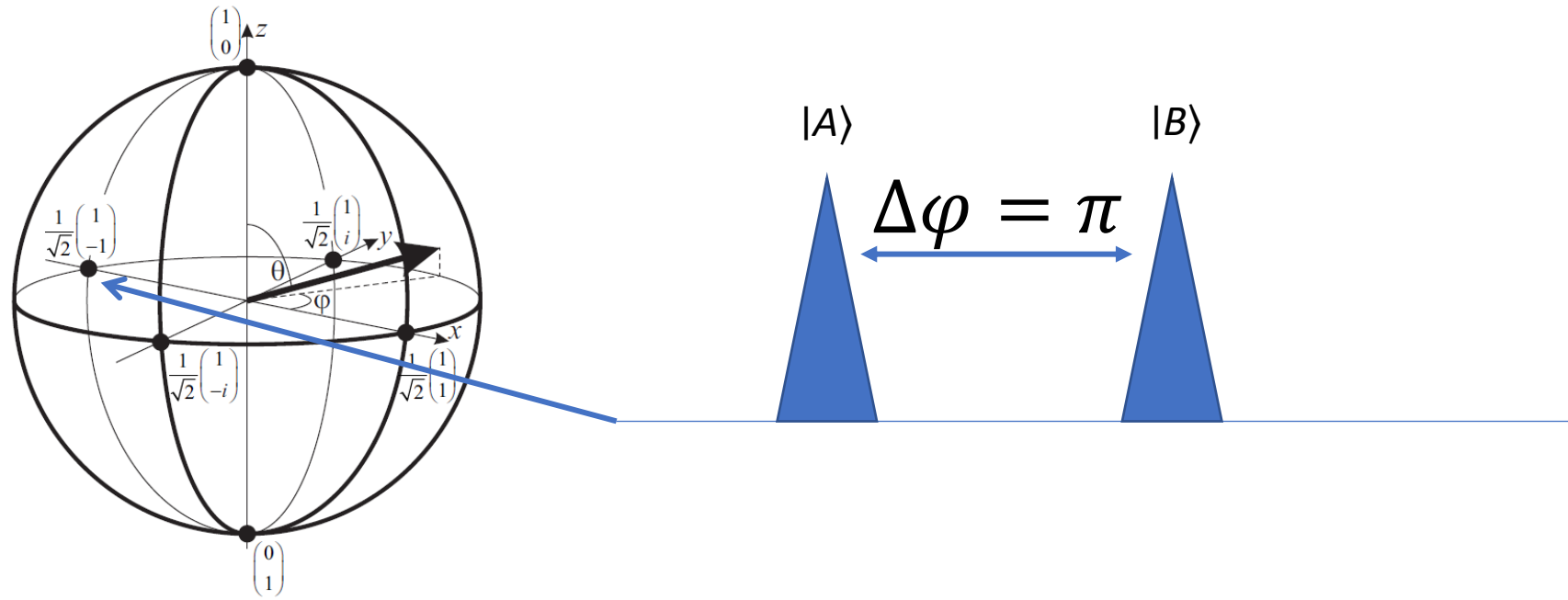

Figure 6.3: The Bloch sphere.

# States visualization

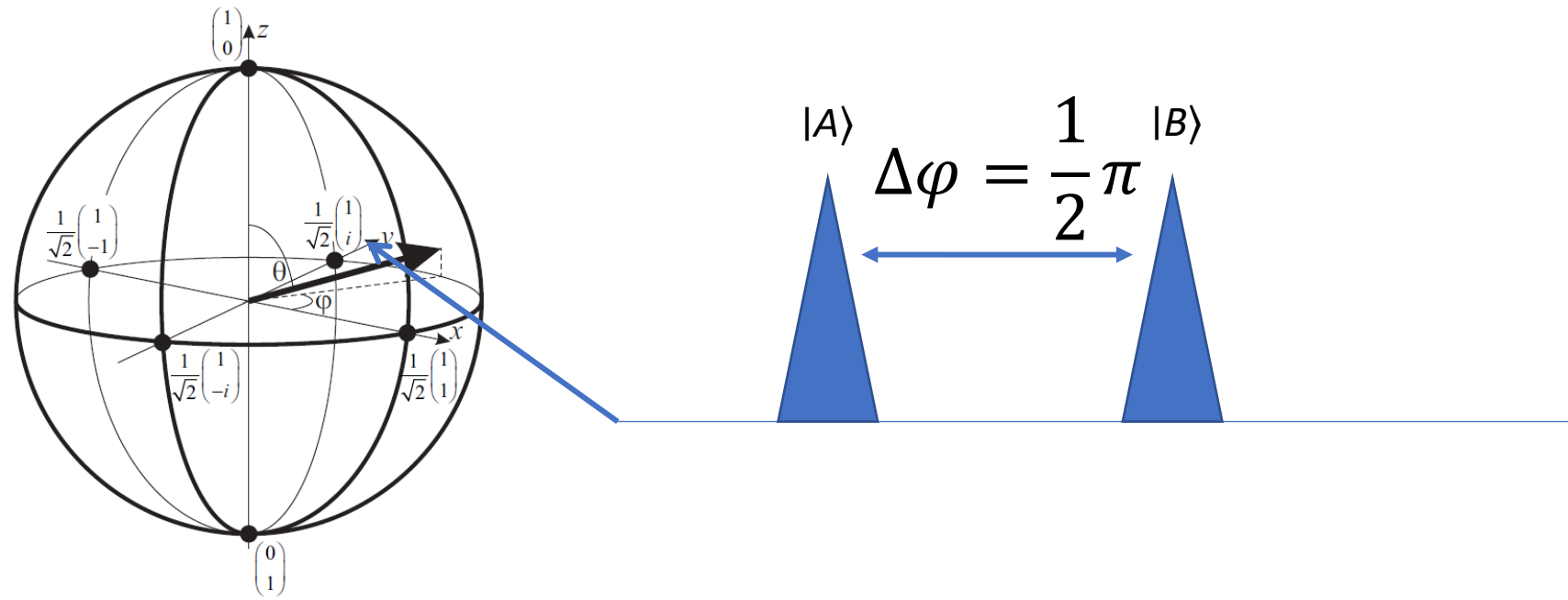

Figure 6.3: The Bloch sphere.

# States visualization

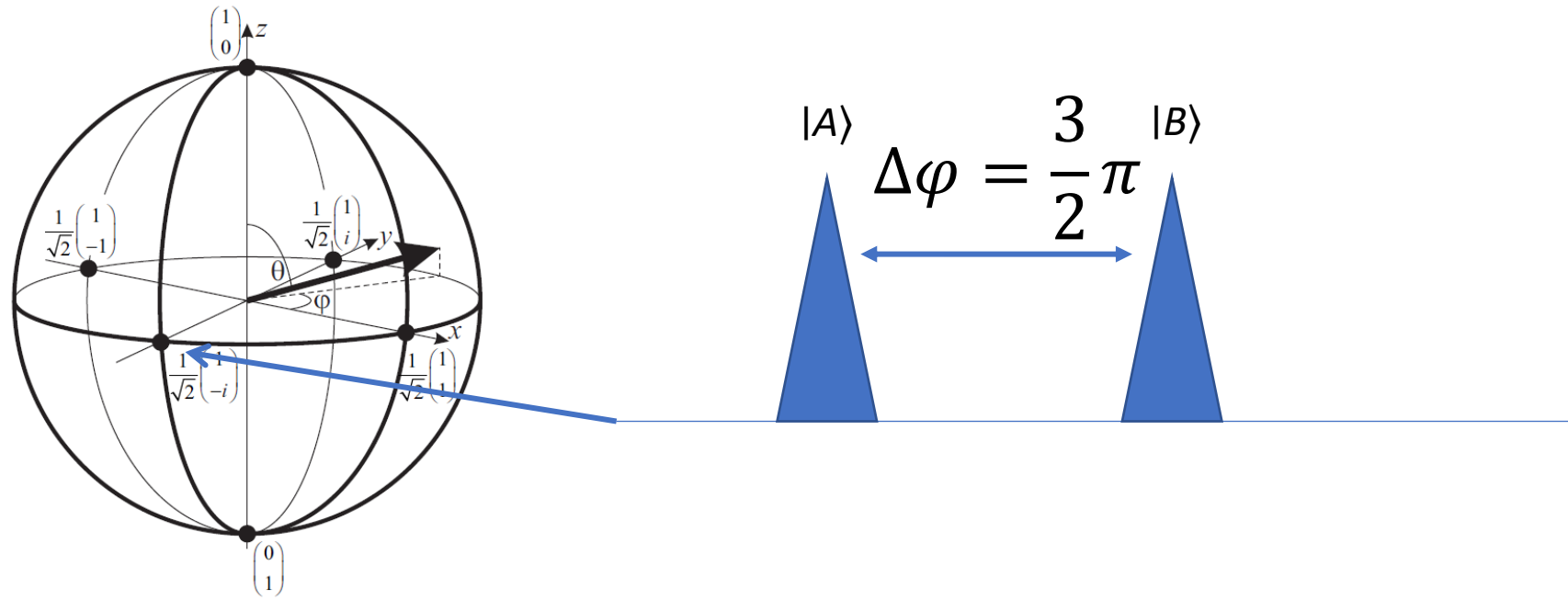

Figure 6.3: The Bloch sphere.

# States vizualization

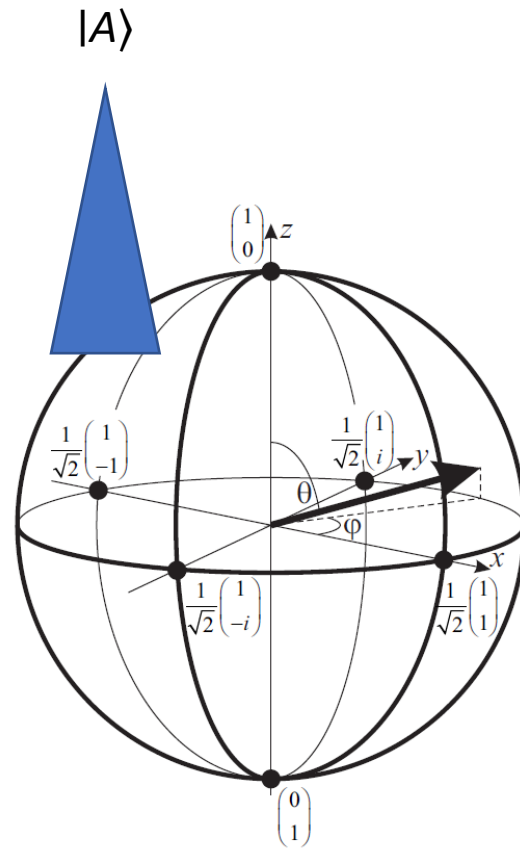

Figure 6.3: The Bloch sphere.

# States vizualization

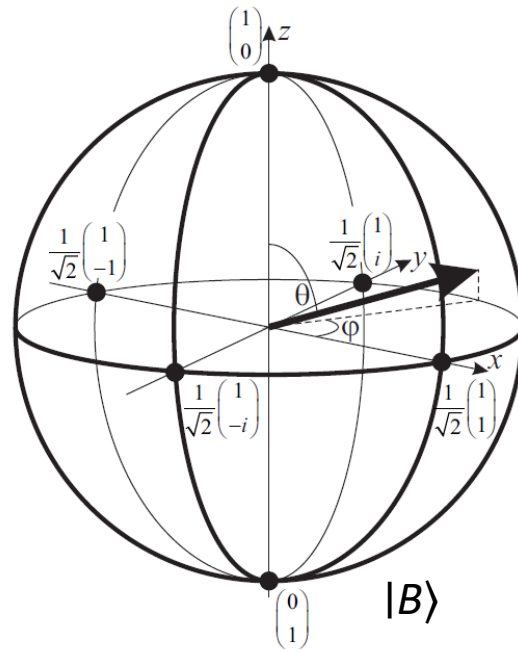
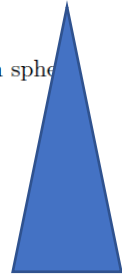

Figure 6.3: The Bloch sphere



# Phase and polarization

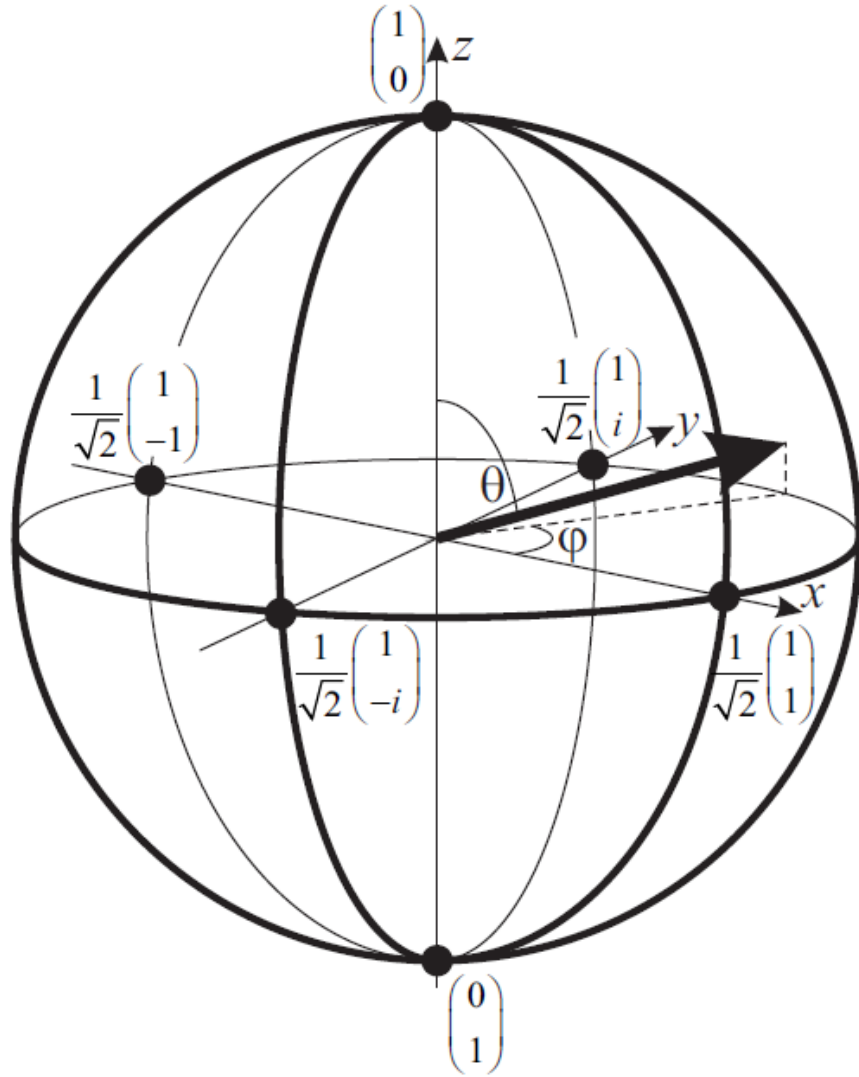
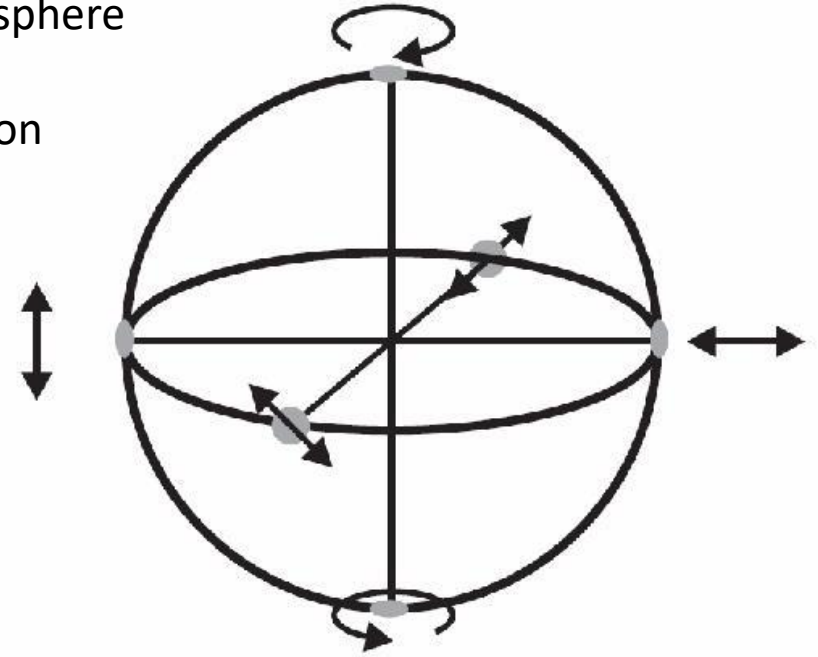

Figure 6.3: The Bloch sphere.

Poincaré sphere  
in case of  
polarization





# Polarization of Photons

- Direction of oscillation of the electric field associated to a lightwave

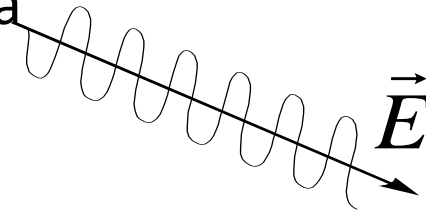

- Polarization states

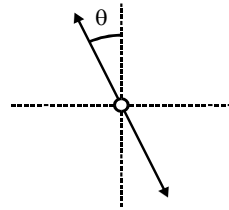

- What can we do with it ?

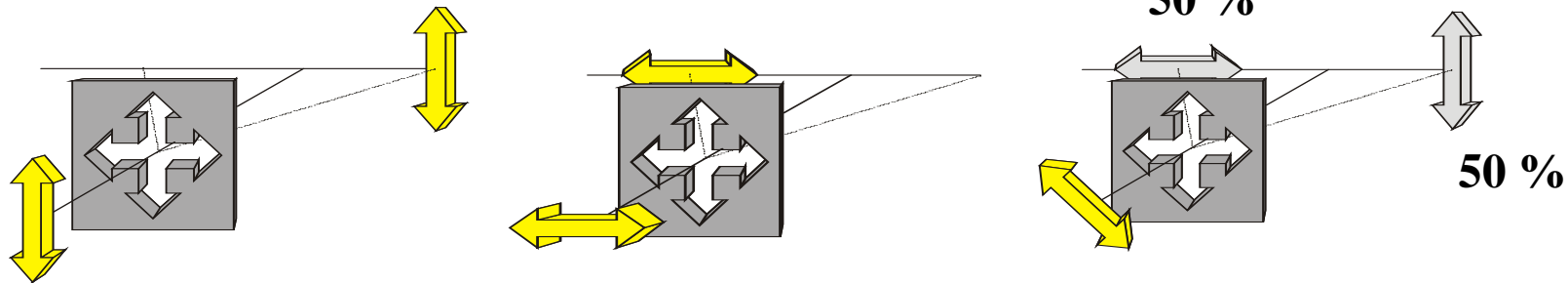

# How do we prepare states?



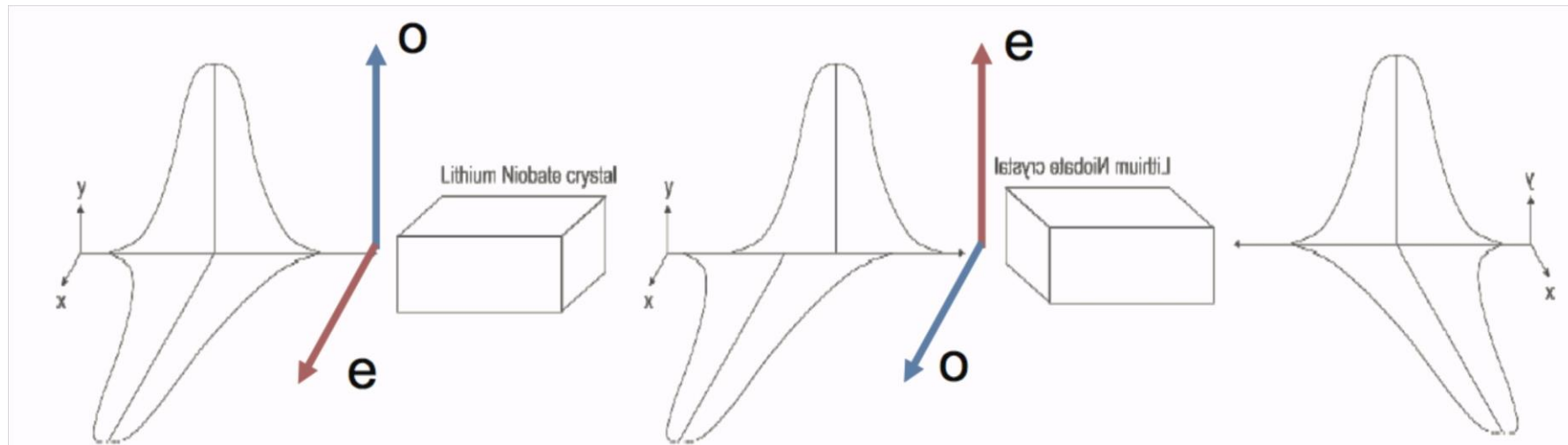





- We decide to use modern 10GHz fiber phase modulator as Pockels cell
- Even small time imbalance will break interference in the case of chirped pulse
- We propose to use identical phase modulator on the Bob side rotated to  $\pi/2$  to compensate the polarization mode dispersion.



- Bob use this modulator for active basis choice
- Two detectors are used instead of four
- This scheme will allow to make QKD transmitter that of a USB stick size.
- *A. Duplinskiy, V. Ustimchik, A. Kanapin, V. Kurochkin, Y. Kurochkin. Low loss QKD optical scheme for fast polarization encoding // Opt. Express 25(23), 28886-28897 (2017).*

# States prepared by Pockels cell

- Polarization distortion induced by long quantum channel are compensated by polarization controller
- At the entrance of Alice's polarization controller amplitudes of two polarization components should be equal (polarization is not obligatory linear)
- BB84 states are not obligatory diagonal +45, diagonal -45, left and right. It can be any pair of maximally non orthogonal states combined by equal horizontal

$\Delta\phi$	SOP	$\Delta\phi$	SOP
0		0	
$\pi/2$		$\pi/2$	
$\pi$		$\pi$	
$3\pi/2$		$3\pi/2$	



# Continuous variable operate infinite dimensions

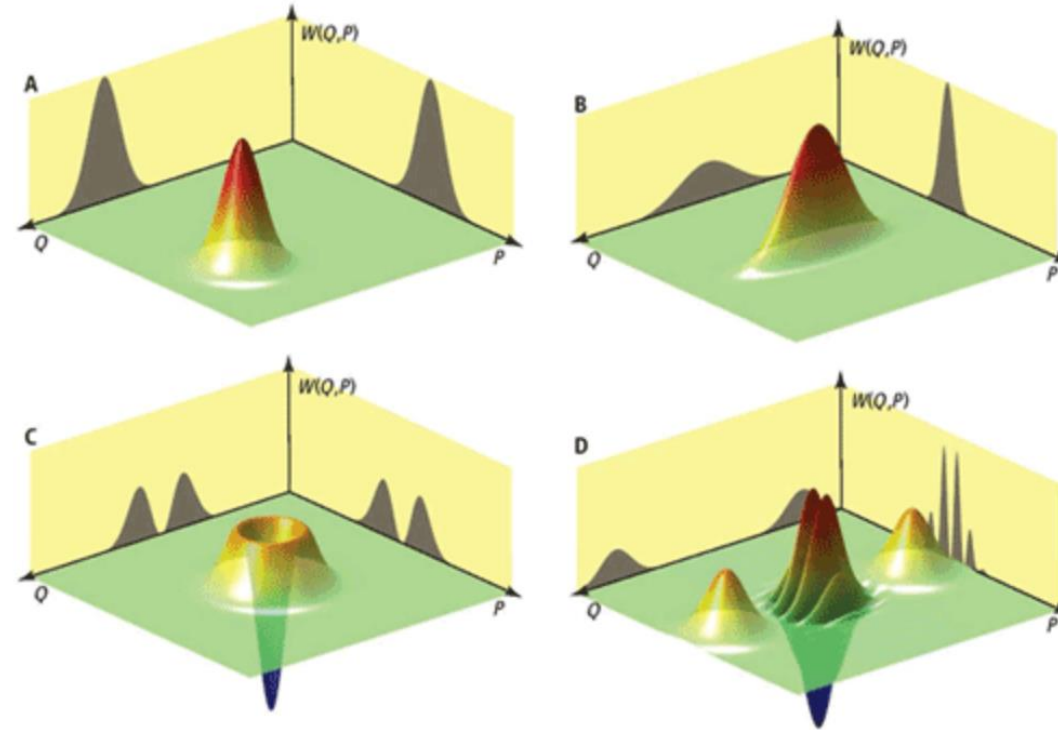
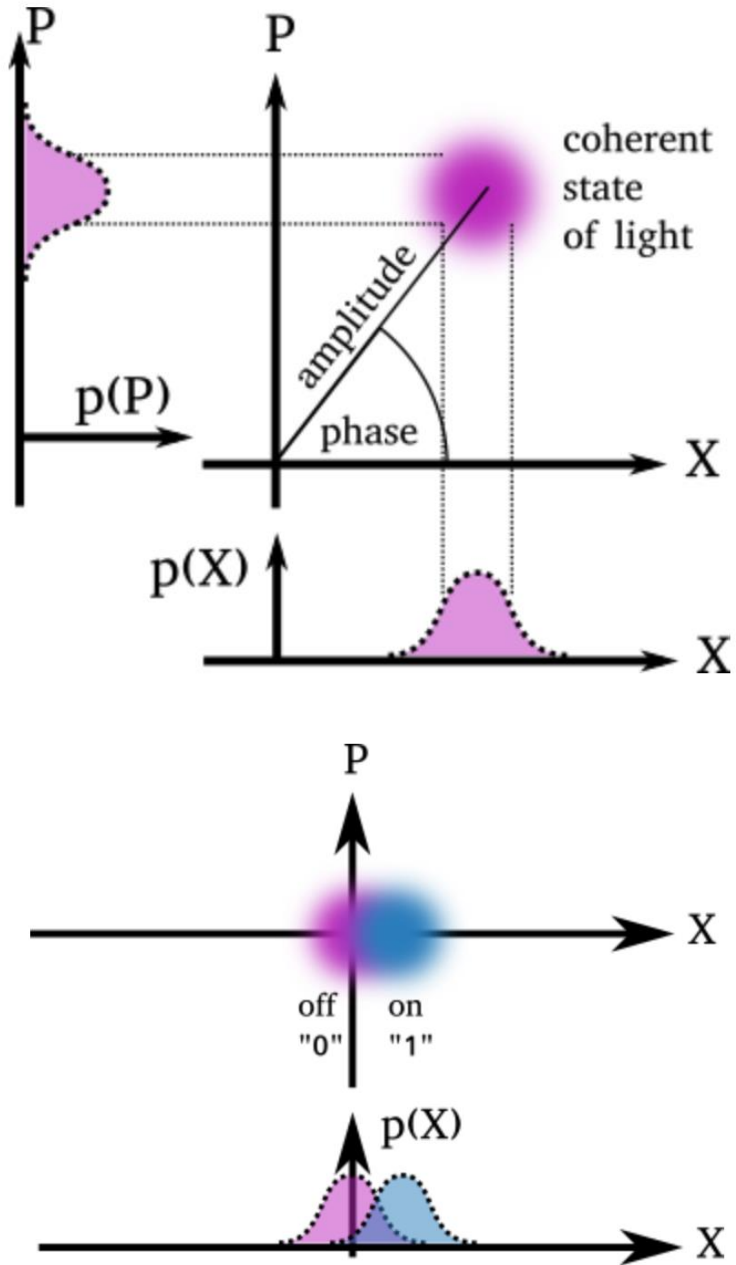

Credit: P. Grangier, "Make It Quantum and Continuous", Science (Perspective) 332, 313 (2011)

# Quantum cryptography is beautiful application of single particle

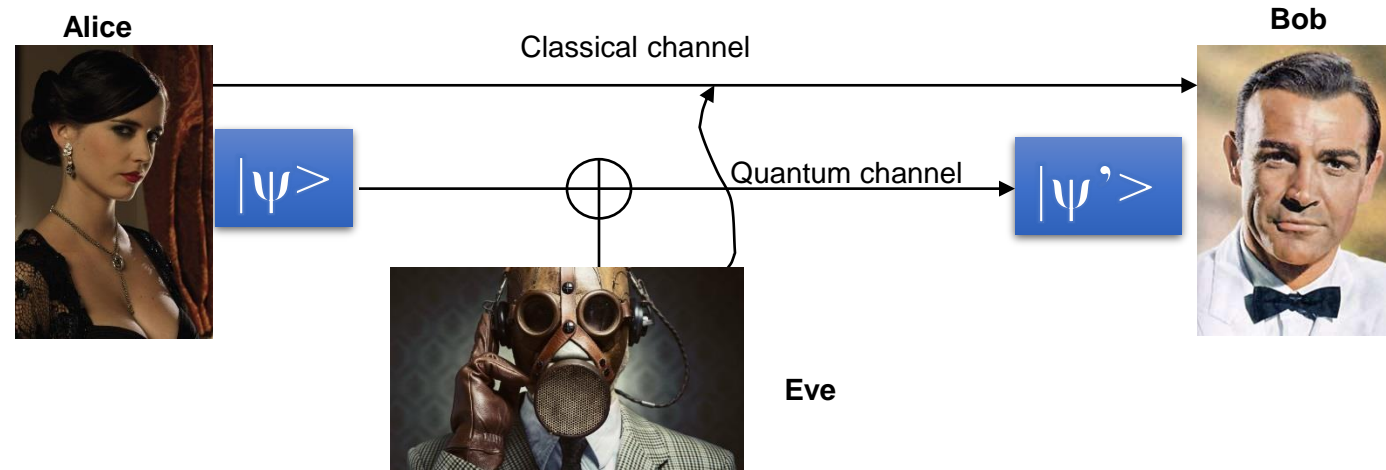

Alice and Bob: to estimate the Eve's information  $I_{AE}$  on key

$\left\{ \begin{array}{l} I_{AE} \text{ small: Error correction + Privacy amplification} \\ I_{AE} \text{ large: } \text{STOP} \end{array} \right.$

Experimentalists: to maximize  $I_{AB}$

Theorists: to quantify  $I_{AE}$

- New protocols -> higher tolerance to noise, bit rate and distance growth
- New methods to prepare and measure states -> reduce size and cost
- Security analysis and attacks -> search for good model of non-ideal components

Secure now.  
Secure in the future.





# How it looks

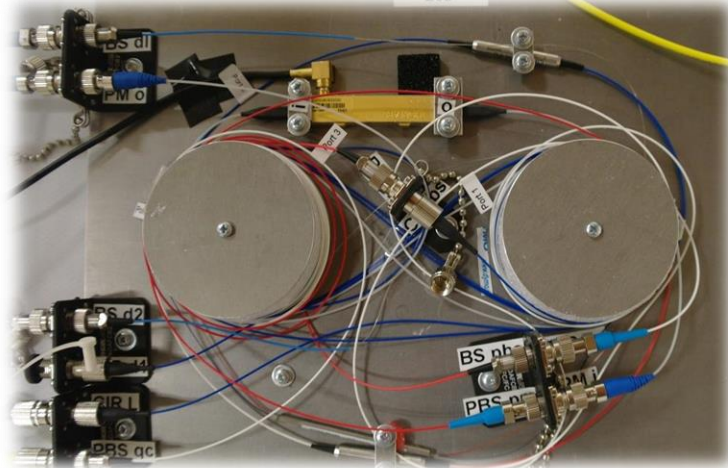
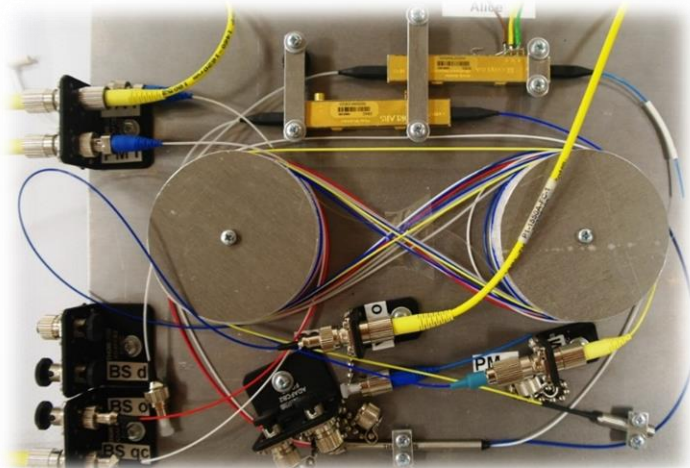
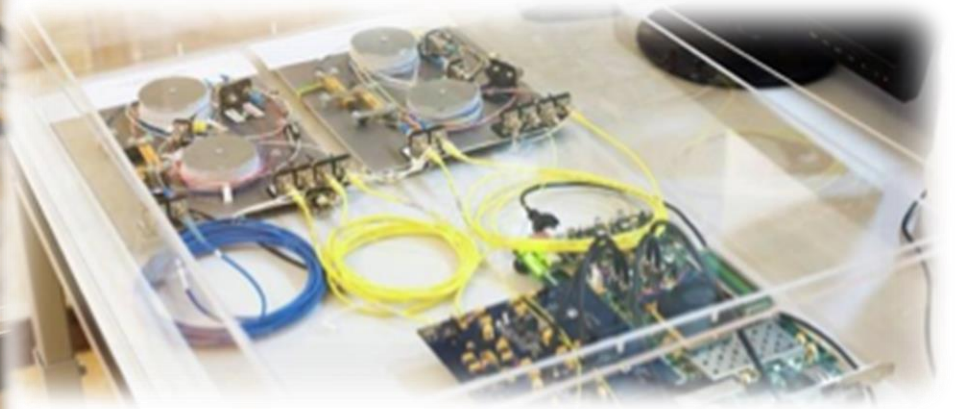
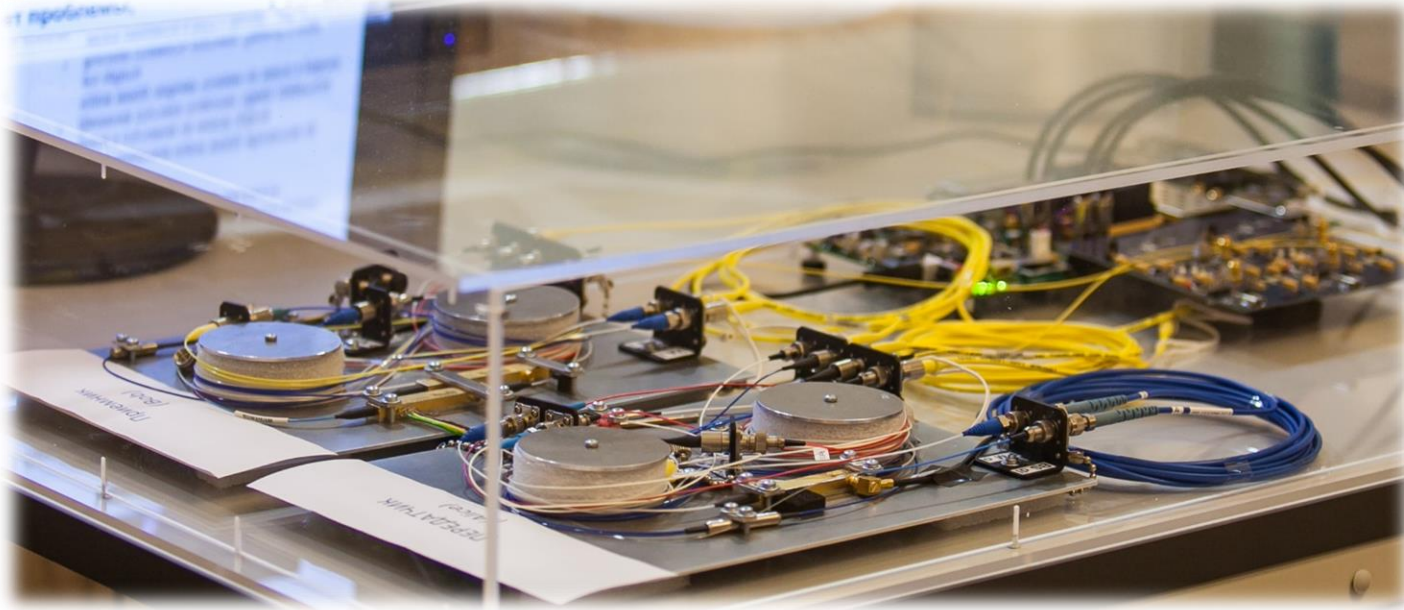

# EMERGING QUANTUM COMMUNICATION INDUSTRY



2018:  
SK Telecom deal at \$130M valuation



2020:  
Quantum Unicorn IPO  
Valuation \$2,3B in 2021



2021:  
\$13.5M Series A Funding  
\$59M valuation





We're looking for talents!

Yury Kurochkin  
yk@goqrates.com

QUANTUM COMMUNICATIONS

# Entangled states

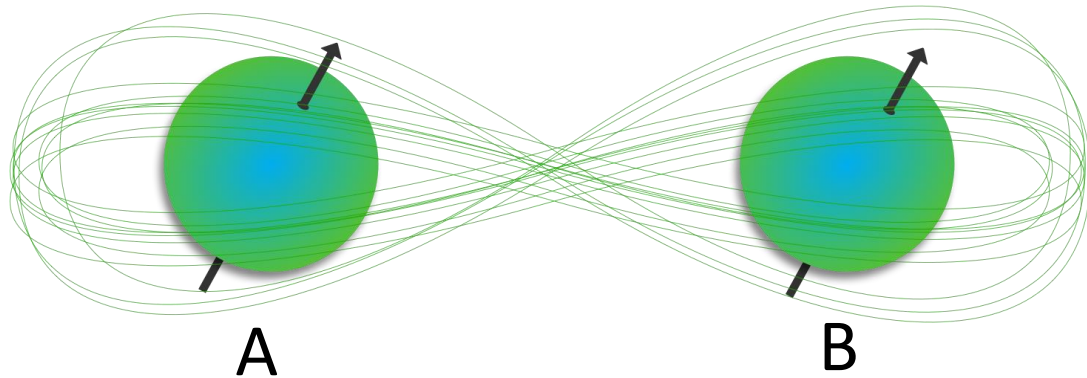

$$\begin{aligned}\Psi &= |\uparrow\uparrow\rangle + |\downarrow\downarrow\rangle = |\uparrow_A\uparrow_B\rangle + |\downarrow_A\downarrow_B\rangle = \\ &= |0_A0_B\rangle + |1_A1_B\rangle\end{aligned}$$

**Can we use it to send information?**

Einstein, A.; Podolsky, B.; Rosen, N. (1935). "Can Quantum-Mechanical Description of Physical Reality Be Considered Complete?". *Physical Review*. 47 (10): 777–780. Bibcode:1935 PhRv...47..777E. doi:10.1103/PhysRev.47.777

Bell, John (1964). "On the Einstein Podolsky Rosen Paradox" (PDF). *Physics*. 1 (3): 195–200. doi:10.1103/PhysicsPhysiqueFizika.1.195

Freedman, Stuart J.; Clauser, John F. (1972). "Experimental Test of Local Hidden-Variable Theories" (PDF). *Physical Review Letters*. 28 (14): 938–941. Bibcode:1972PhRvL..28..938F. doi:10.1103/PhysRevLett.28.938.

Alain Aspect (1976)

Proposed experiment to test the nonseparability of quantum mechanics, *Phys. Rev. D* 14, 1944

# How do we implement annihilation operator in the real experiment?

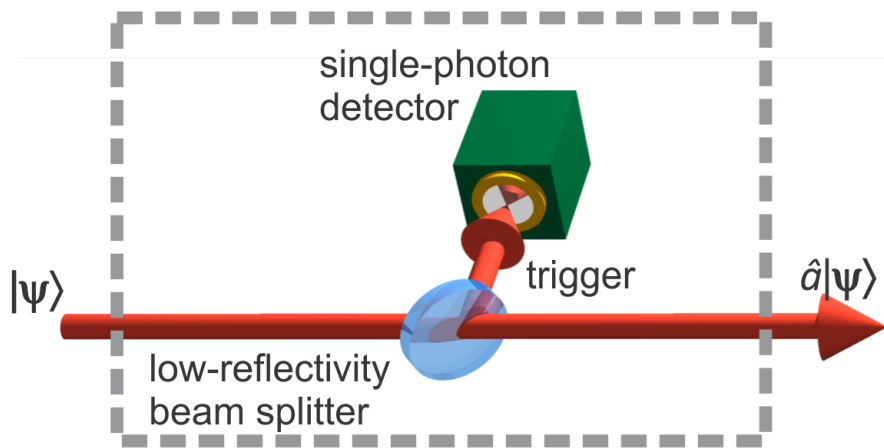

The scheme. A “click” indicates that a photon has been removed from  $|\psi\rangle$

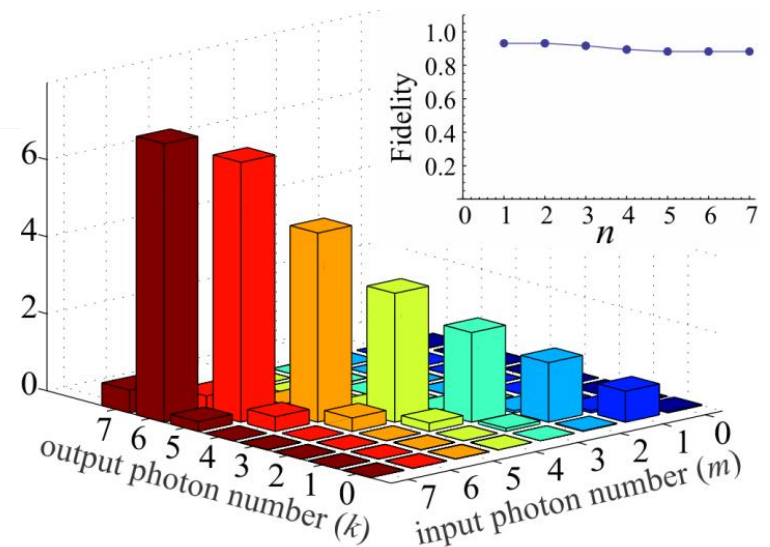

Experimental quantum process tomography

R. Kumar, E. Barrios, C. Kupchak and A.L., PRL **110**, 130403 (2013)

Annihilation operator is non-deterministic

- Trace of the process output is given by the “click” probability
- The process involving the annihilation operator can change the state at a distance but cannot be used for faster than light communication because we need to transmit information about click

# Irreversibility of Measurements

Incoming photon polarized at  $90^\circ$

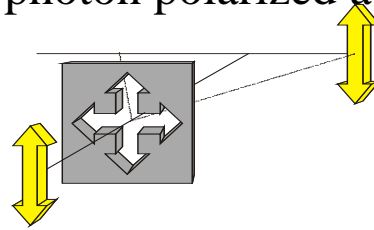

Incoming photon polarized at  $45^\circ$

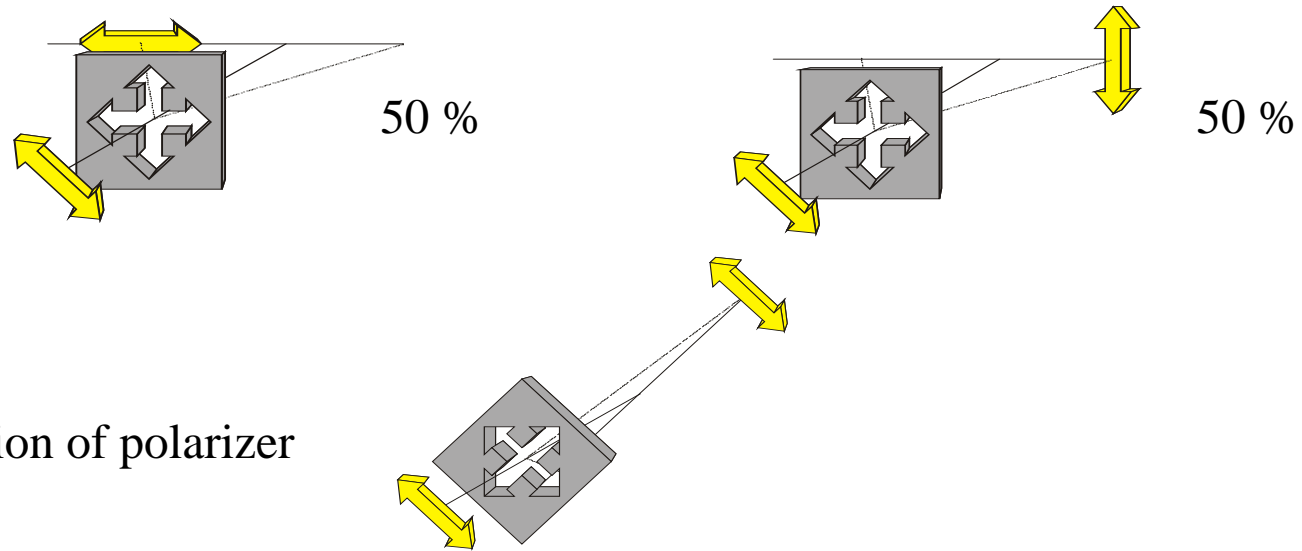

# Детектор одиночных фотонов – ключевой элемент

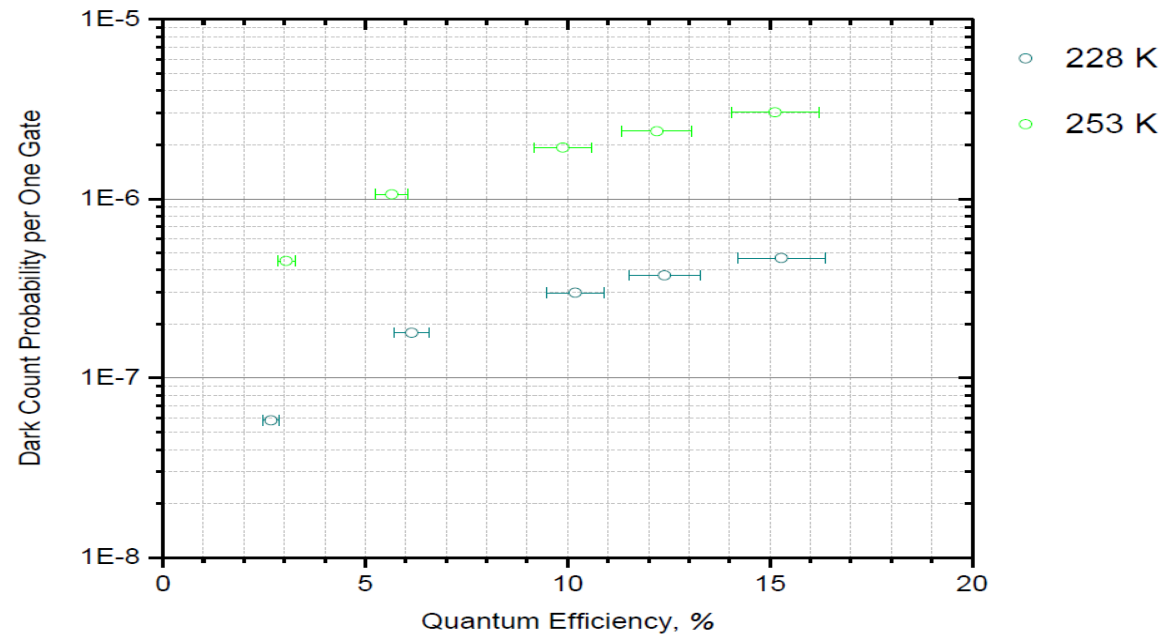

- Квантовая эффективность 10%
- Шумы  $3 \cdot 10^{-7}$
- Частота повторения стробов 300 MHz.
- Ширина окна приема сигнала 400 ps

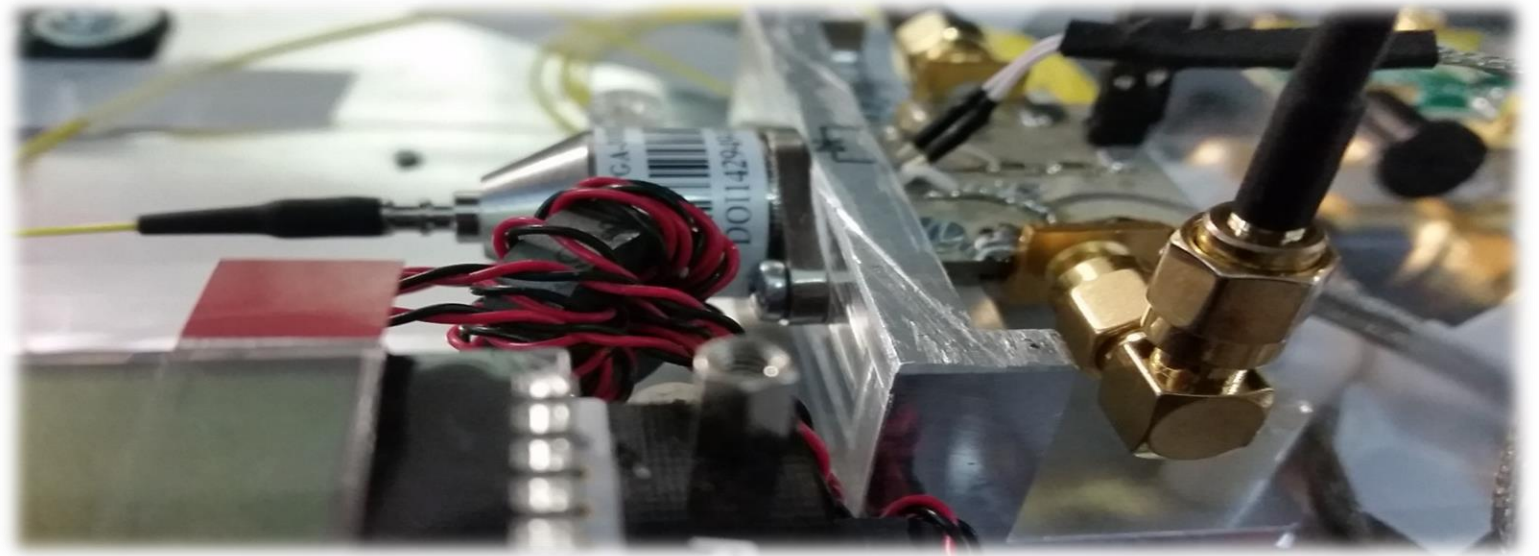

# High bit rate quantum random number generator

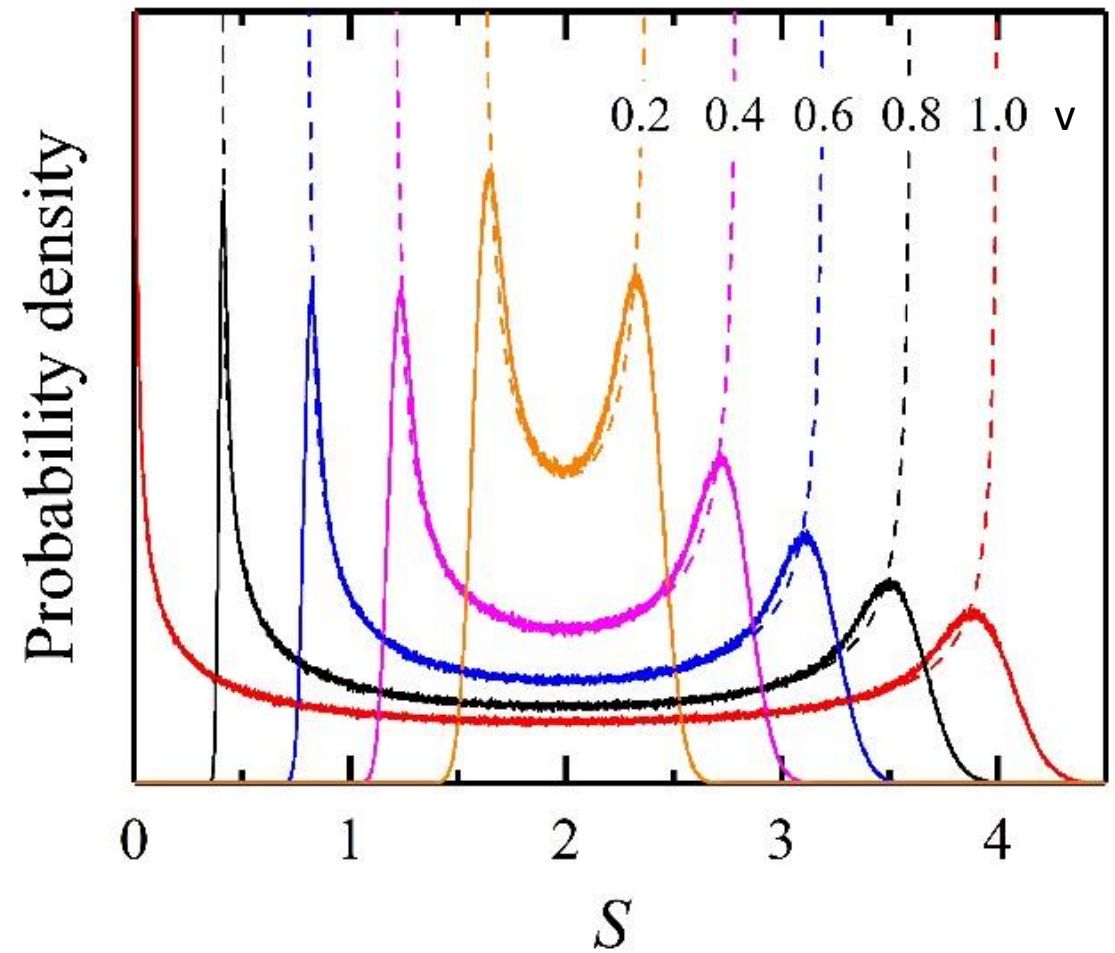
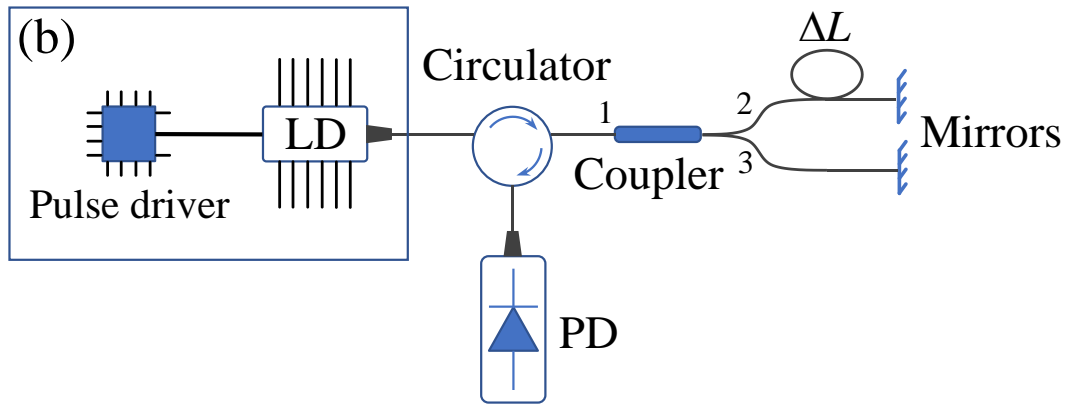
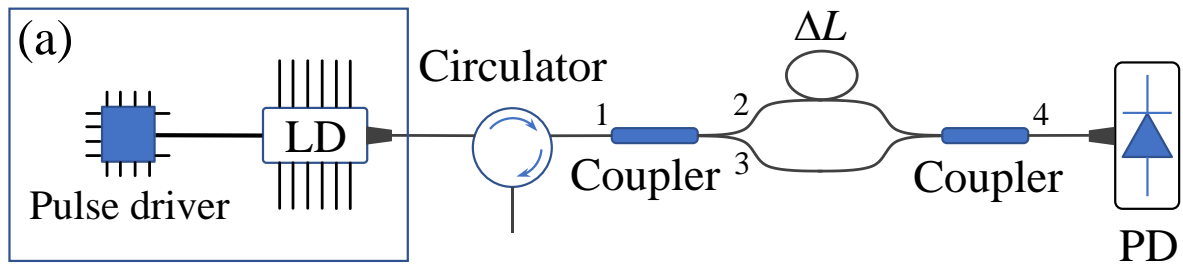



# 2017-2018 Sberbank field tests

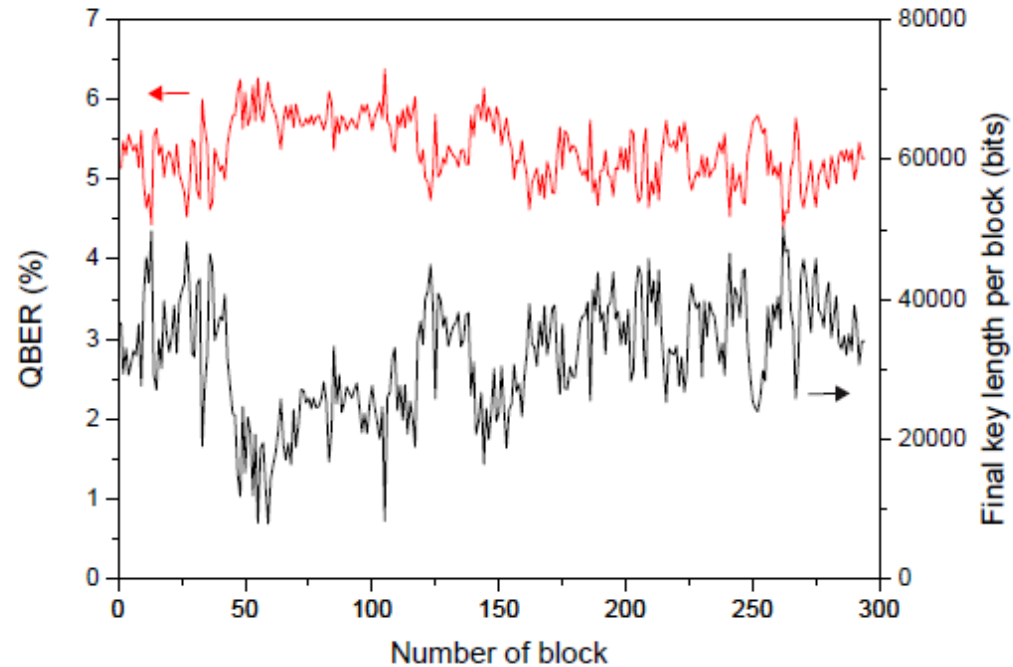
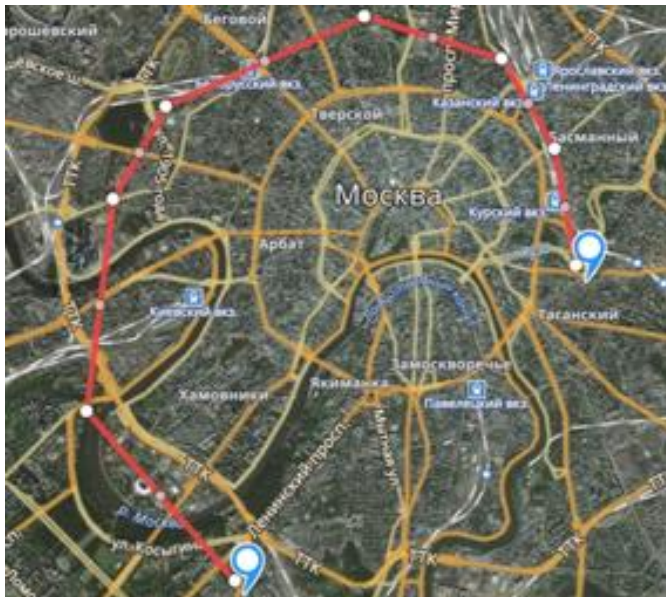
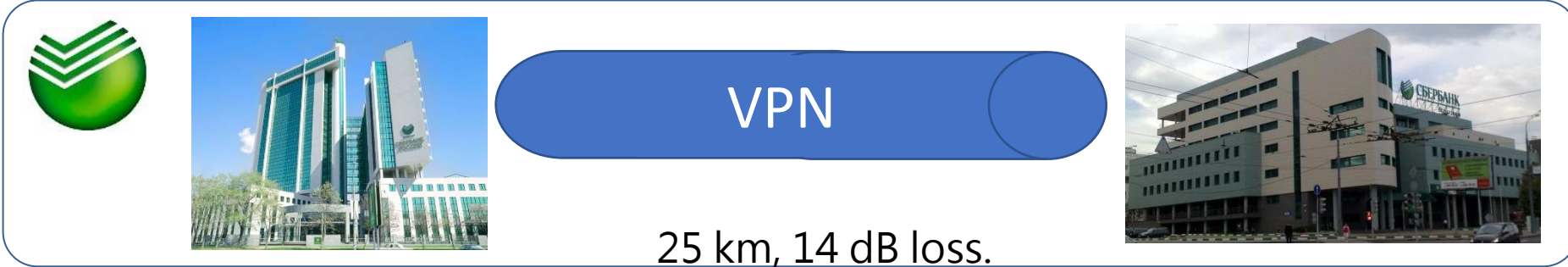

- Two Sberbank offices
- 25 km line, 8 segments, 14 dB loss
- 300 MHz pulse repetition rate
- BB84+ decoy
  - Signal 0,175 ph/pulse
  - Decoy 0,067 ph/pulse
- QBER 5,5 %
- 2 kbit/s raw key
- 0,1-0,9 kbit/s secret key
- Key consumption 256 bit per 400s.

# QKD distance limit is driven by exponential loss

## Estimated key generation rate

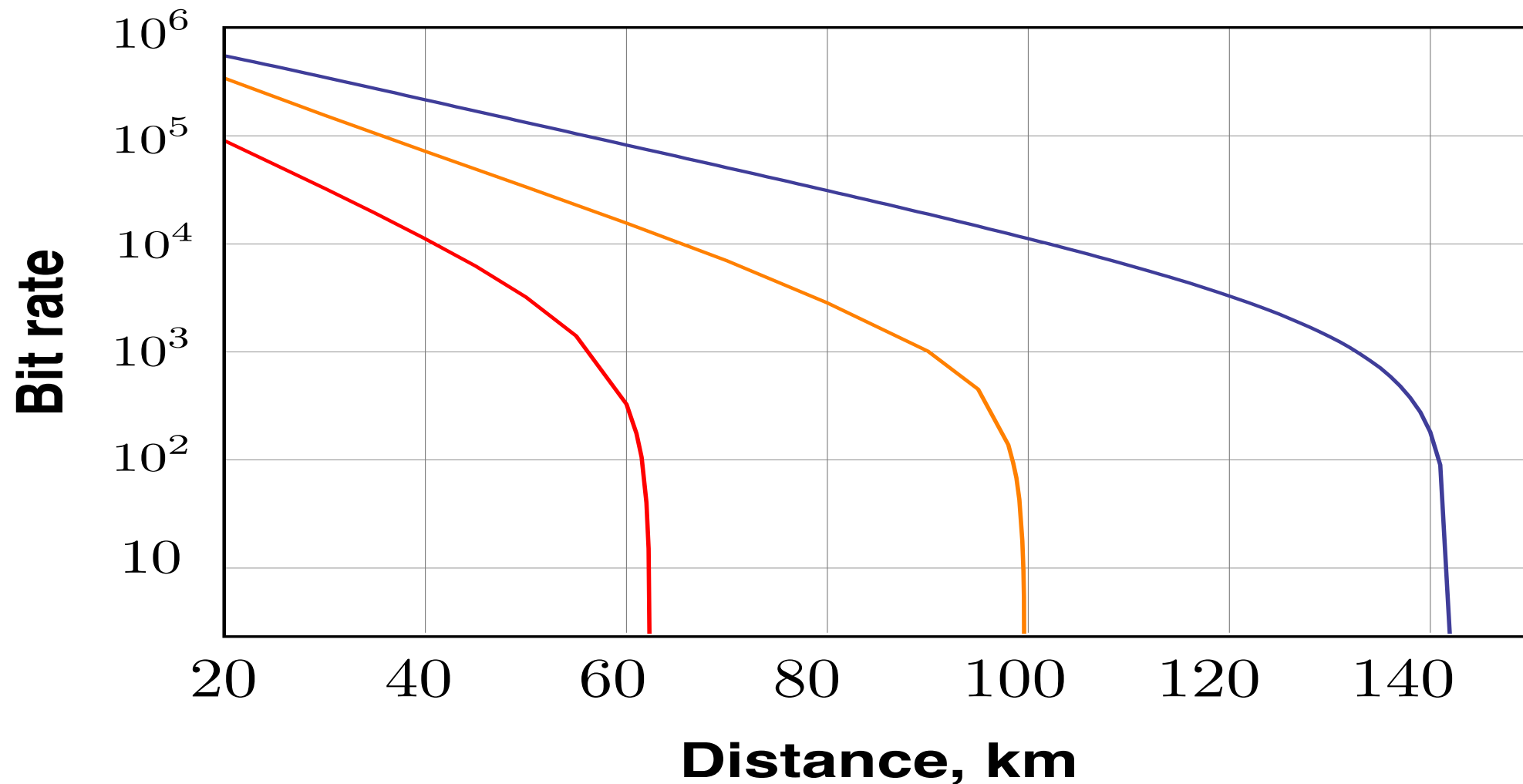



# Quantum repeaters

- Problem: to get 1 photon after 1000 km line you need to make  $\approx 10^{20}$  ts what is not practical
- Practical distances are within 100 km in the external lines and within 400 km in the lab (less than 1 bit/s)
- Solution comes from classical communication, we need a repeater
- What is a repeater
  - Device that captures a signal, regenerates it, and sends it further
- Classical repeater will inevitably cause noise
- Quantum repeater
  - Must capture and regenerate a photon without measuring its polarization
  - Requires *memory* for efficient operation
  - Requires entangled states

We need to create quantum correlations between Alice and Bob...

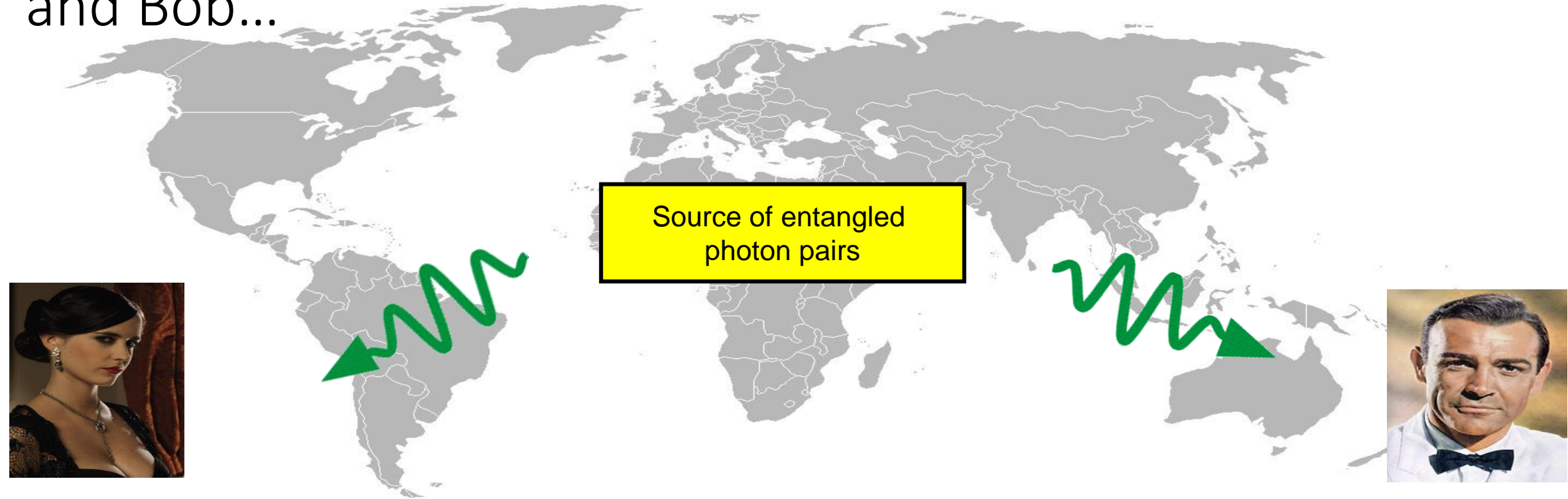

 The photons are likely to get lost on their way

# Entanglement swapping

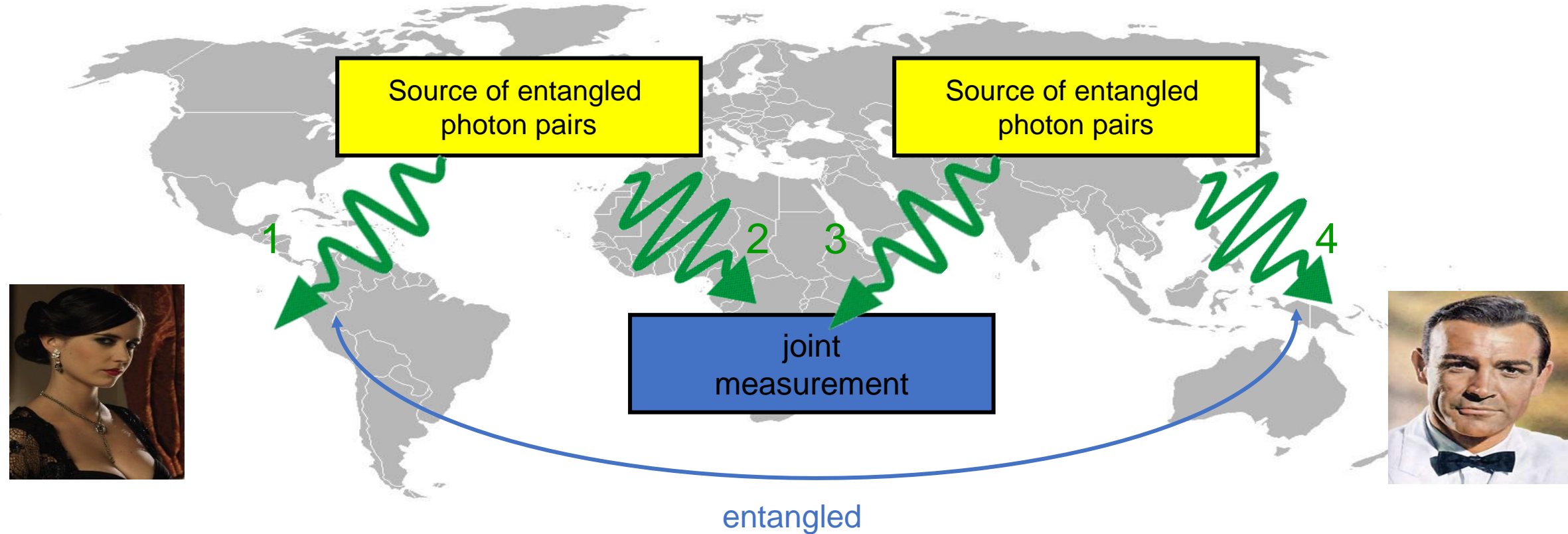

- Long-distance entanglement can be created by *entanglement swapping*
  - A Bell measurements on modes 2 and 4 entangles modes 1 and 4
  - This protocol has much in common with teleportation

# Quantum relay

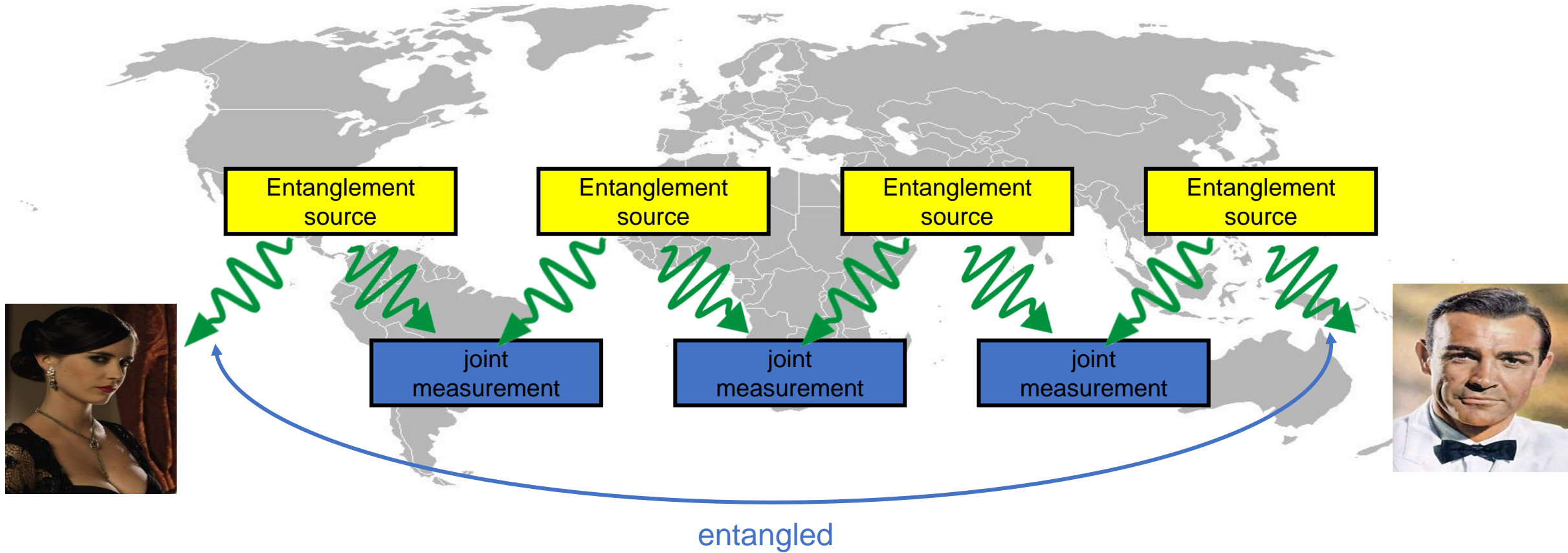

Long-distance entanglement can be created by *entanglement swapping*

☹️ but to succeed, all links must work simultaneously.

→ success probability still decreases exponentially with distance.

# The role of memory

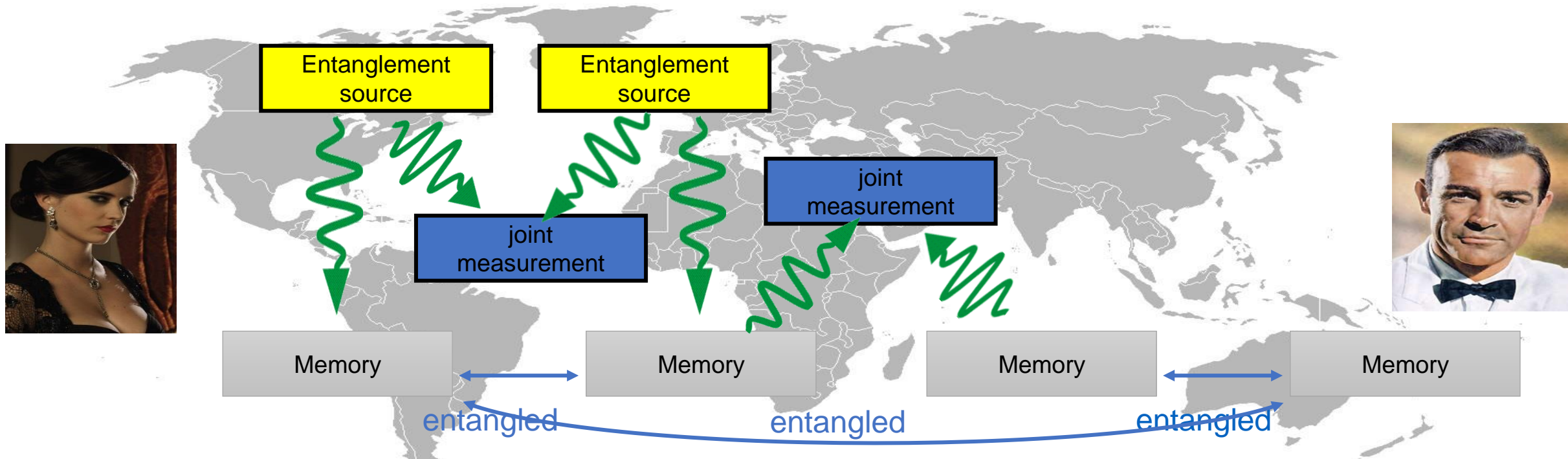

- **But if we had quantum memory,**
  - entanglement in a link could be stored... until entanglement in other links has been created, too.
  - Bell-measurement on adjacent quantum memories... will create the desired long-distance entanglement.
  - Alice can teleport her photon to Bob



# Quantum repeater

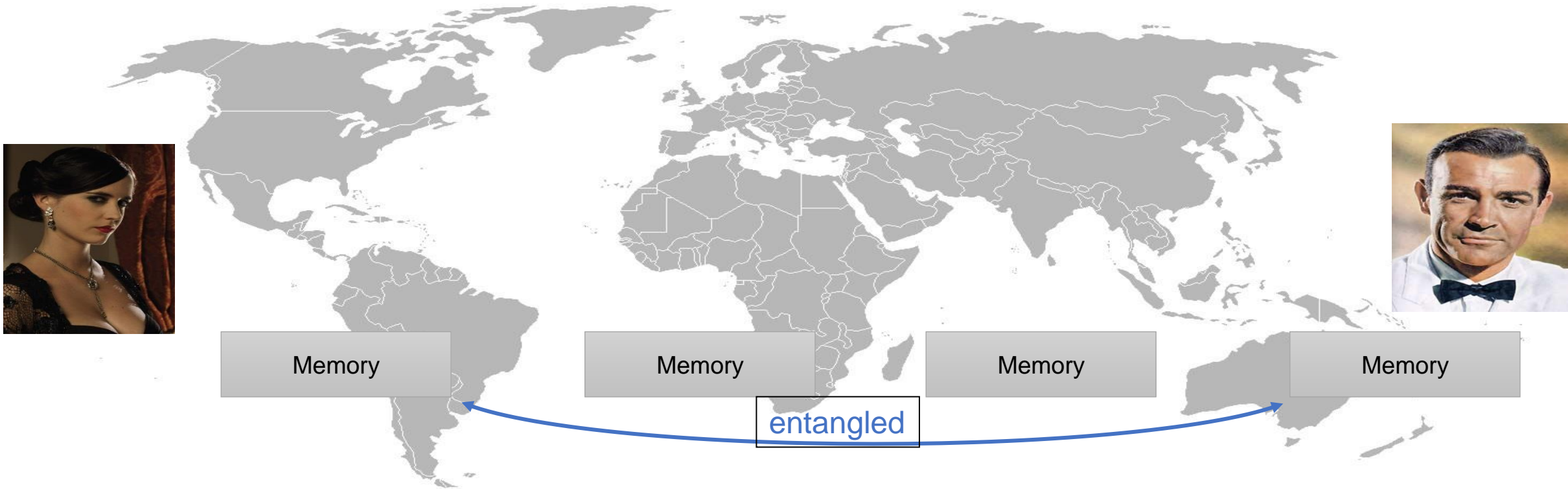

- **This technology is called *quantum repeater***
  - Initial idea: H. Briegel *et al.*, 1998
  - In application to EIT and quantum memory: L.M. Duan *et al.*, 2001
- Quantum memory for light is essential for long-distance quantum communications.