

Components of quantum-optical systems

Photon sources _____ **Transmission channels** _____ **“Processing” elements** _____ **Photon detectors**

Attenuated laser source

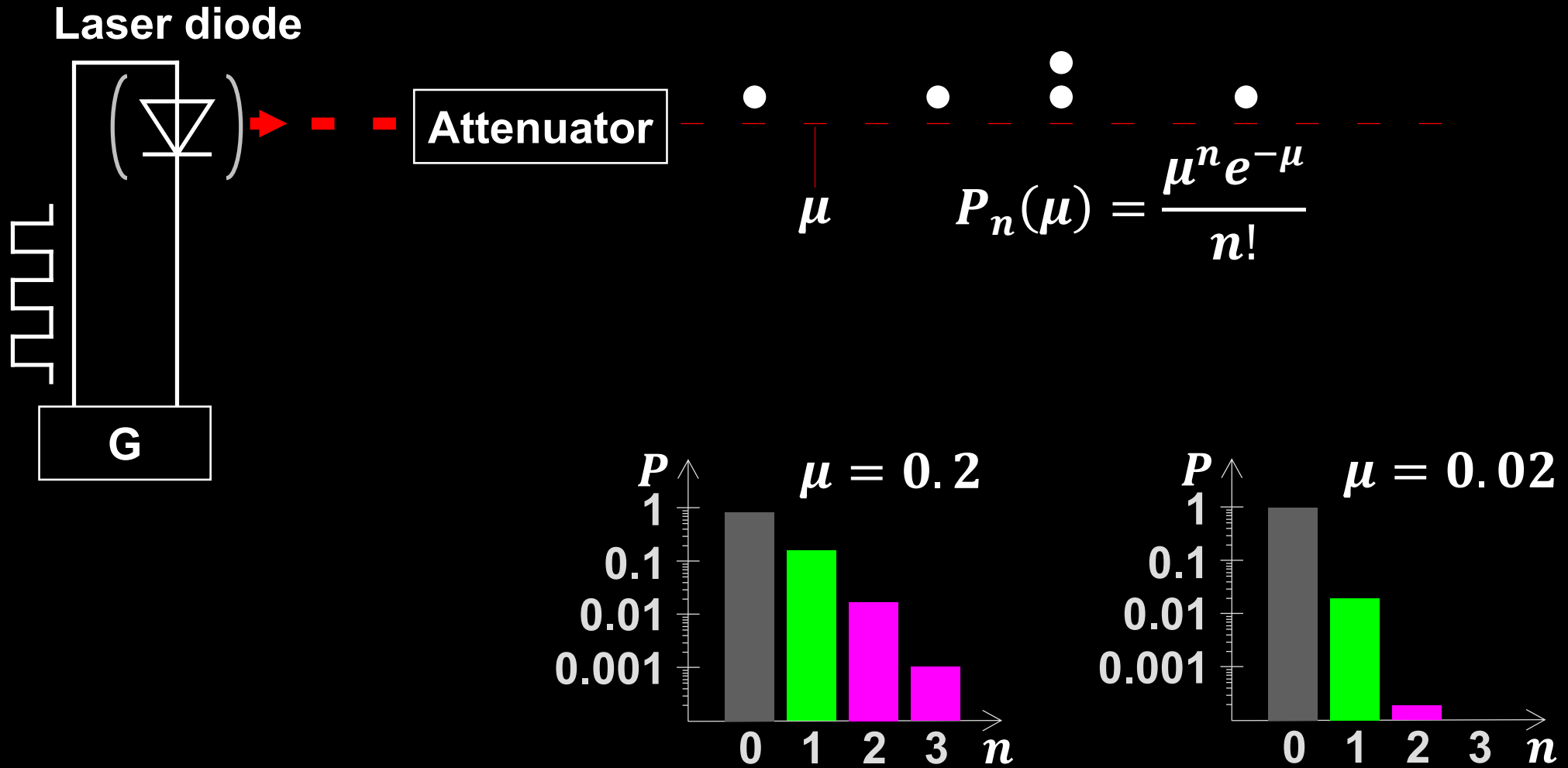

Spontaneous parametric down-conversion

Type II

Energy conservation: $\omega_p = \omega_s + \omega_i$

Momentum conservation: $\vec{k}_p = \vec{k}_s + \vec{k}_i$

$$|\psi\rangle = (|H_1, V_2\rangle + |V_1, H_2\rangle) / \sqrt{2}$$

Heralded photon source

Pump laser

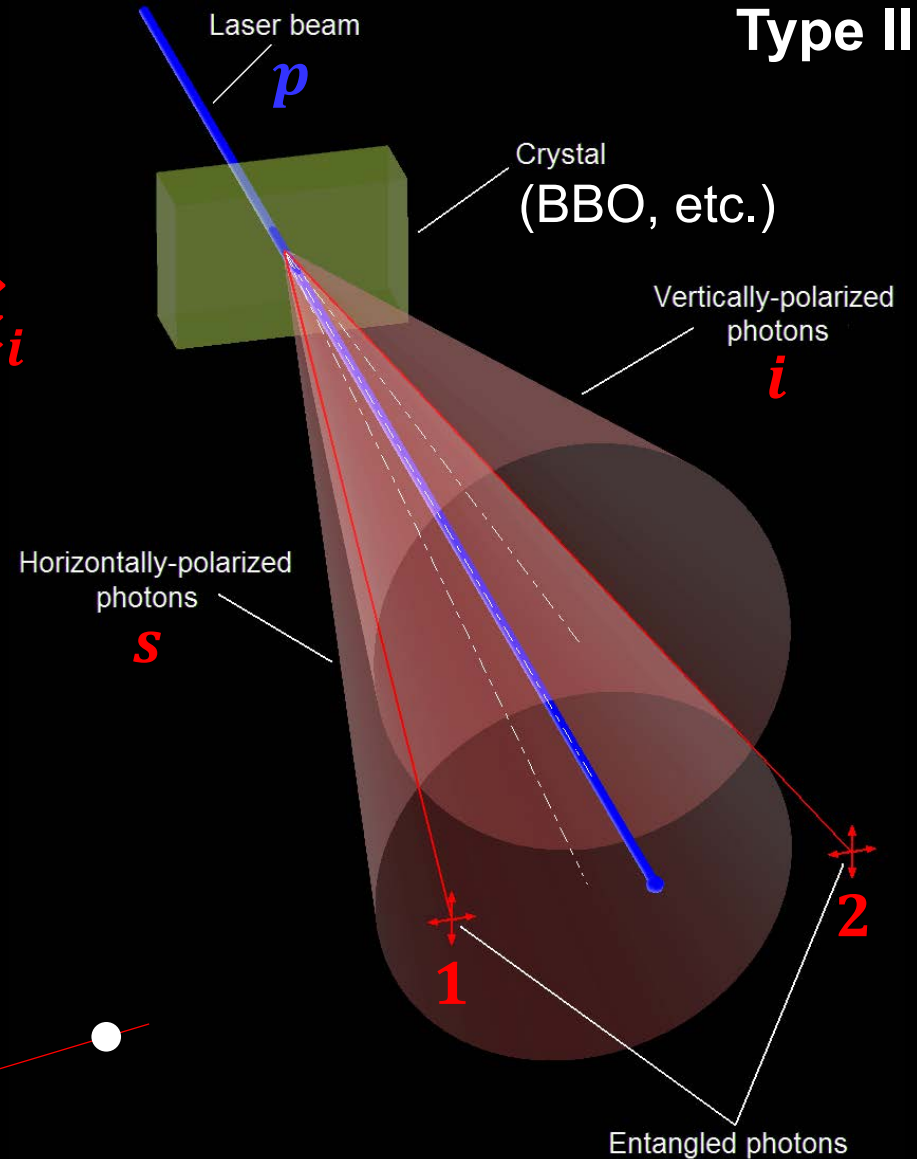
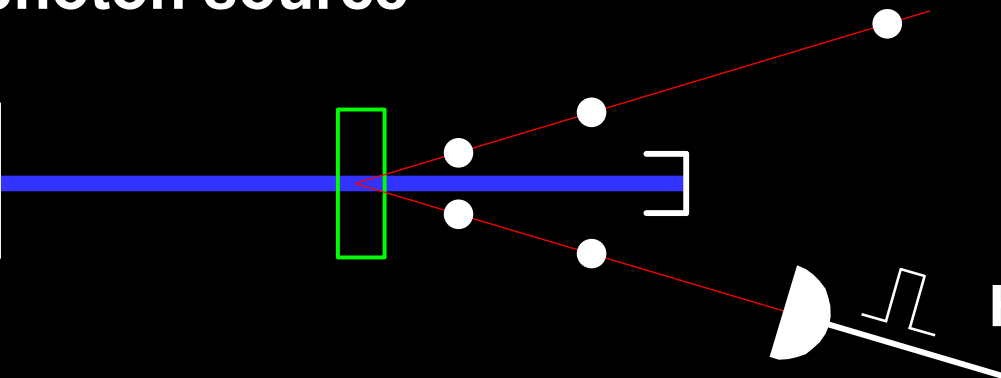

Heralding detector

Transmission in free space

Vacuum:
Gaussian optics

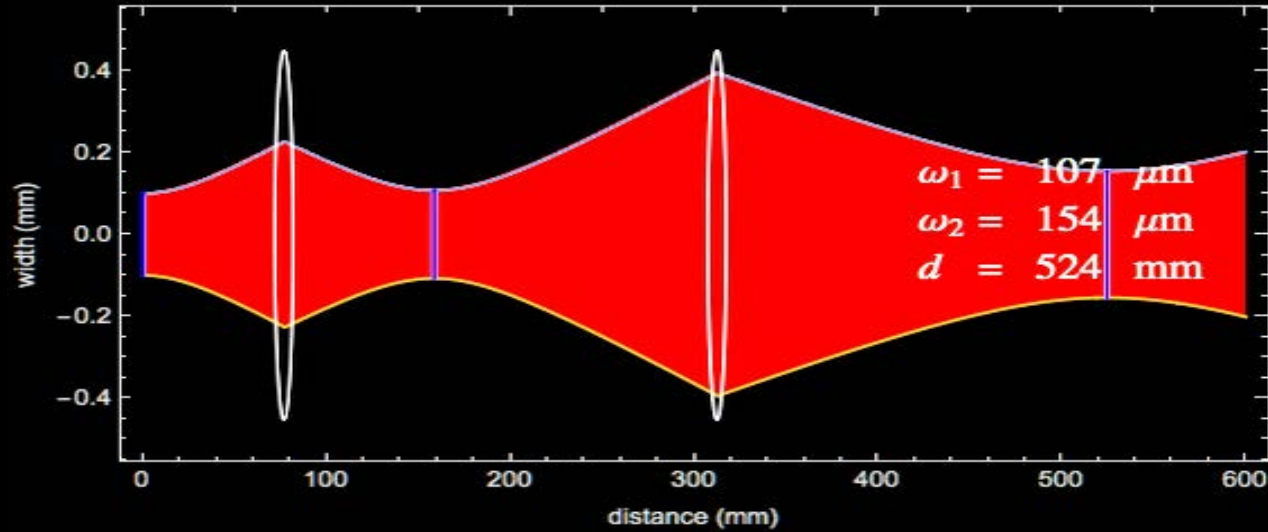

Atmosphere: loss, turbulence

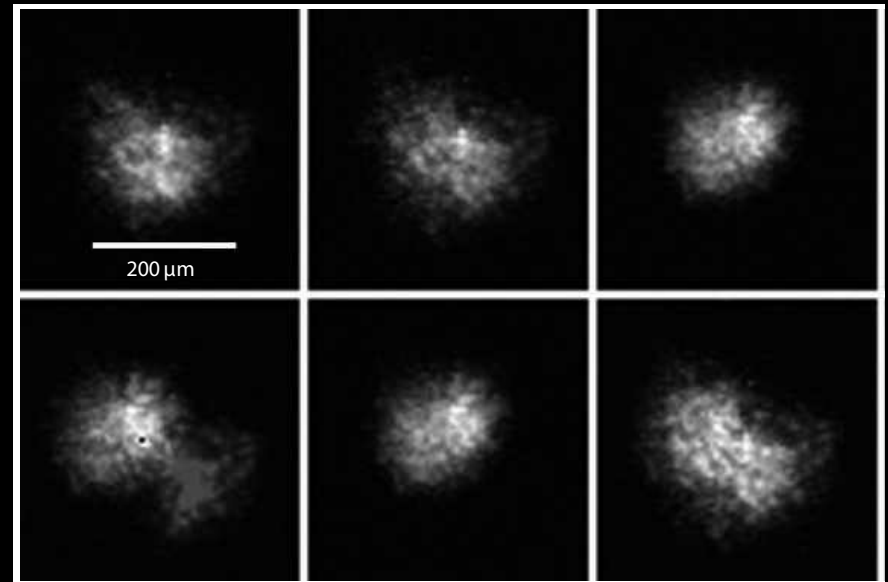
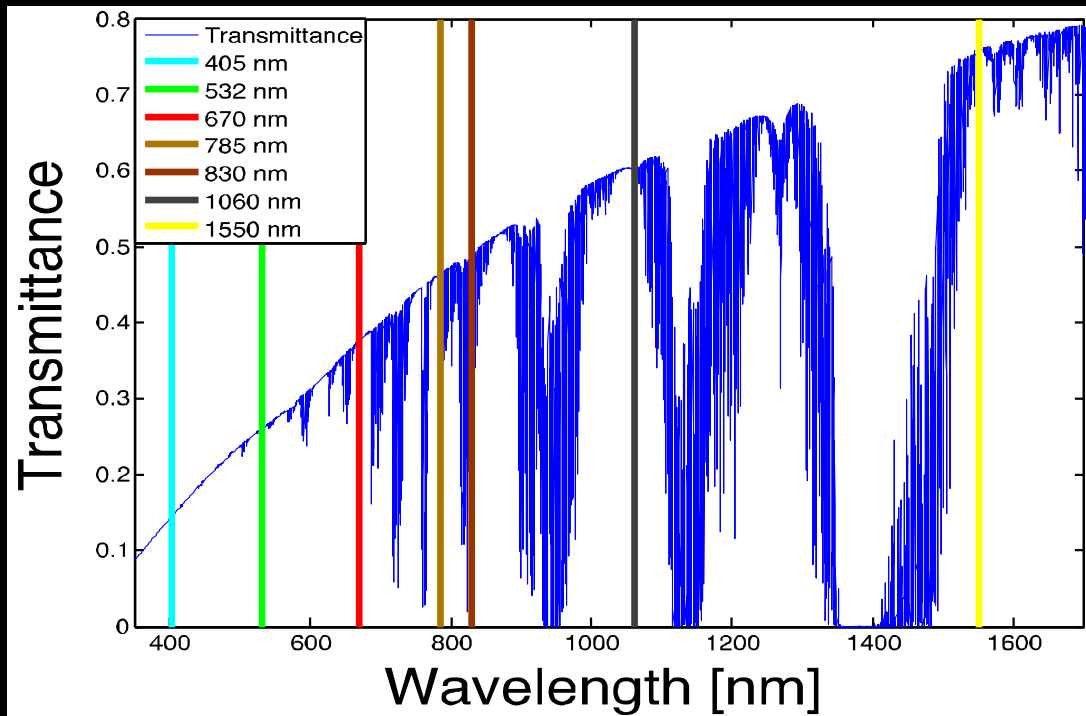

Transmission in optical fiber

Single-mode fiber

125 μm diameter cladding
fused quartz, $n_1 = 1.45$

8 μm diameter core
 $n_2 > n_1$

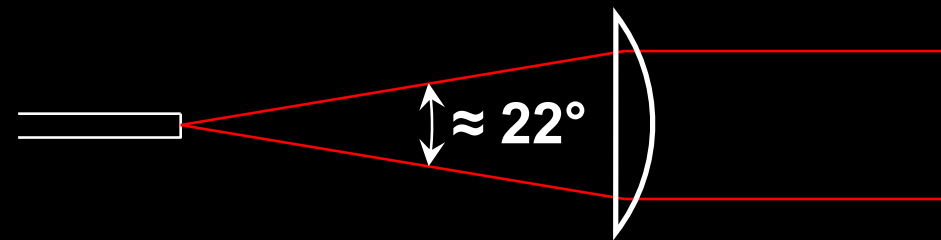
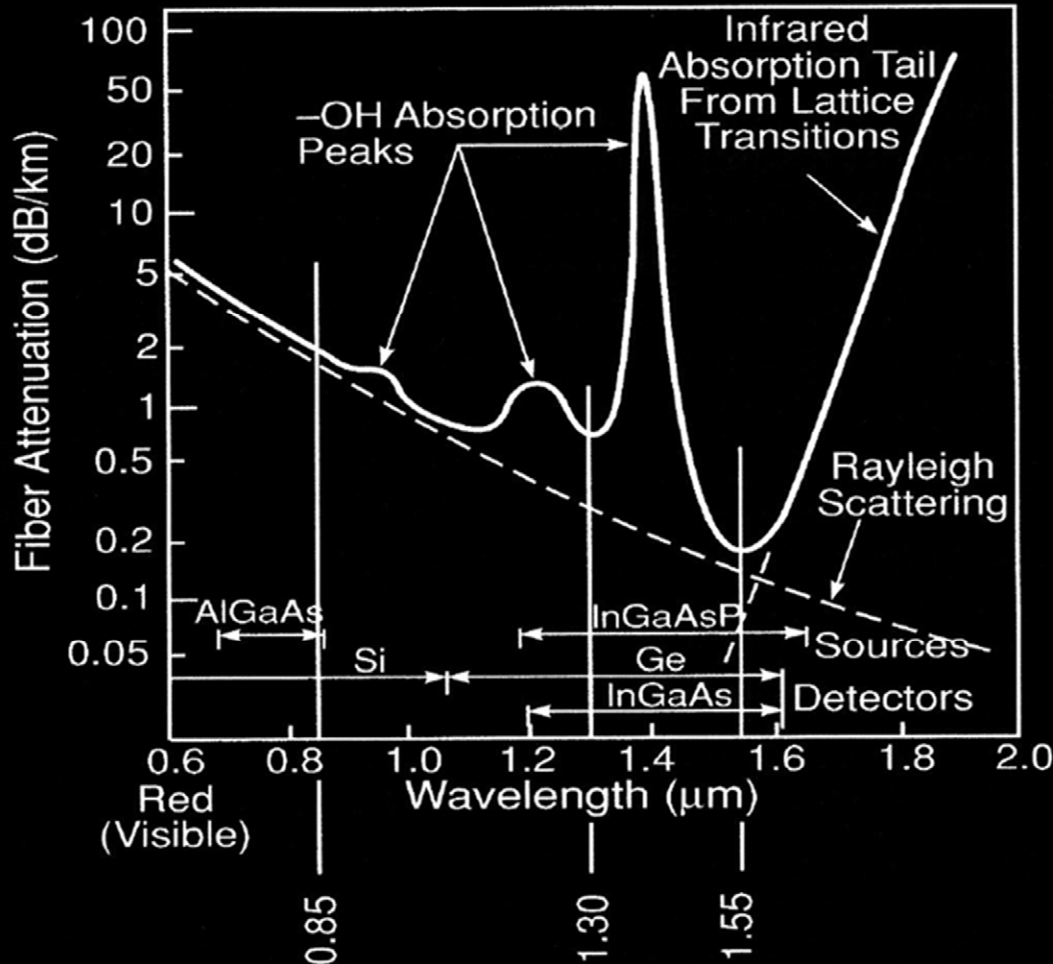
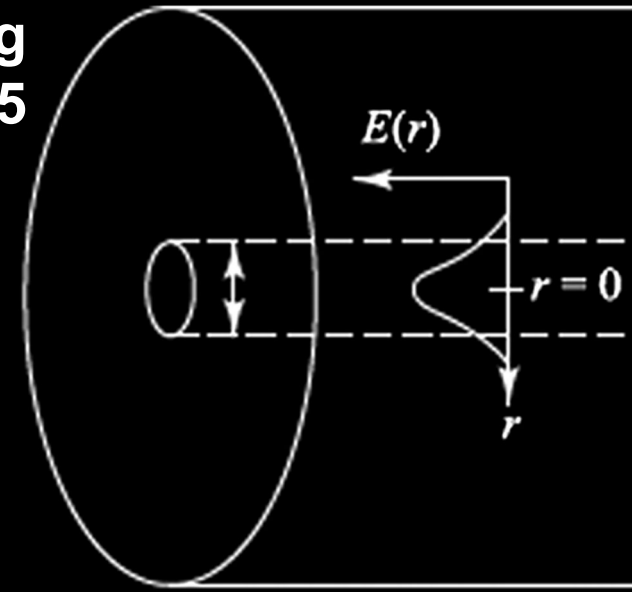

Polarizers

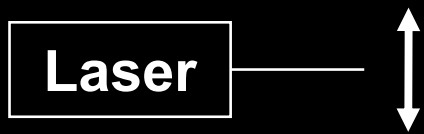

Birefringent polarizing beamsplitter

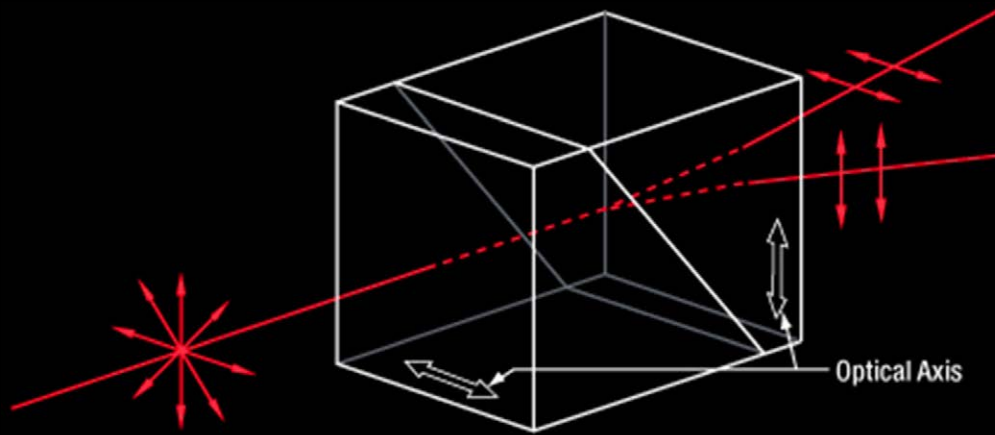

Wollaston prism

Polarizing beamsplitter cube

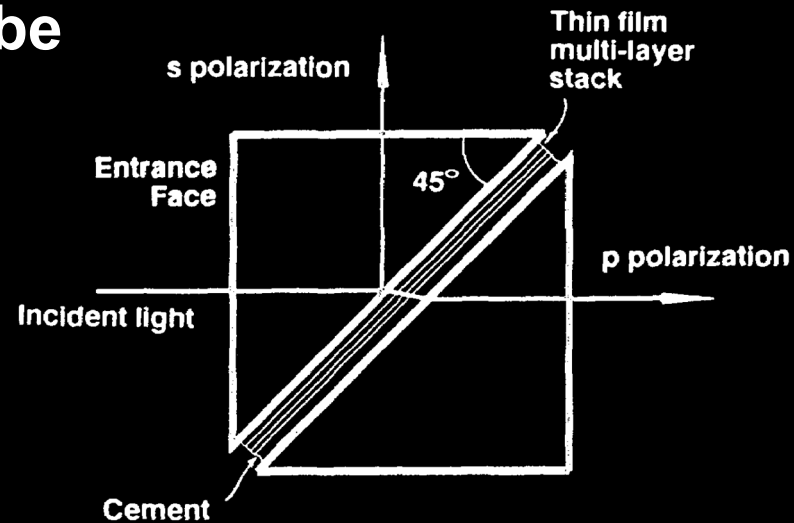
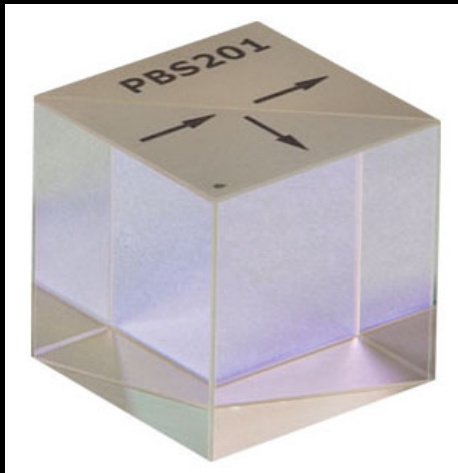

Beamsplitters



50:50
10:90
1:99

Fiber-optic fused beamsplitter (or coupler)

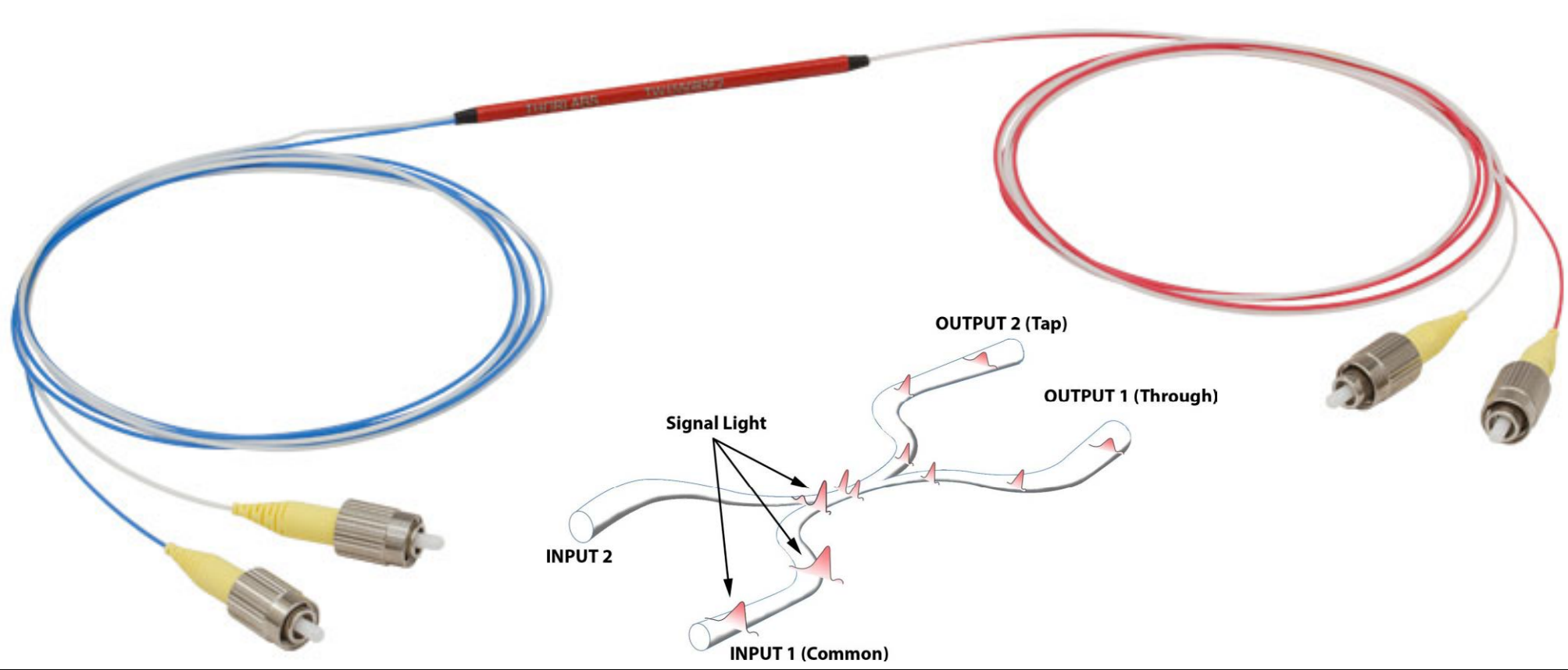

Attenuators

Absorbing or partially reflecting coated glass



Variable

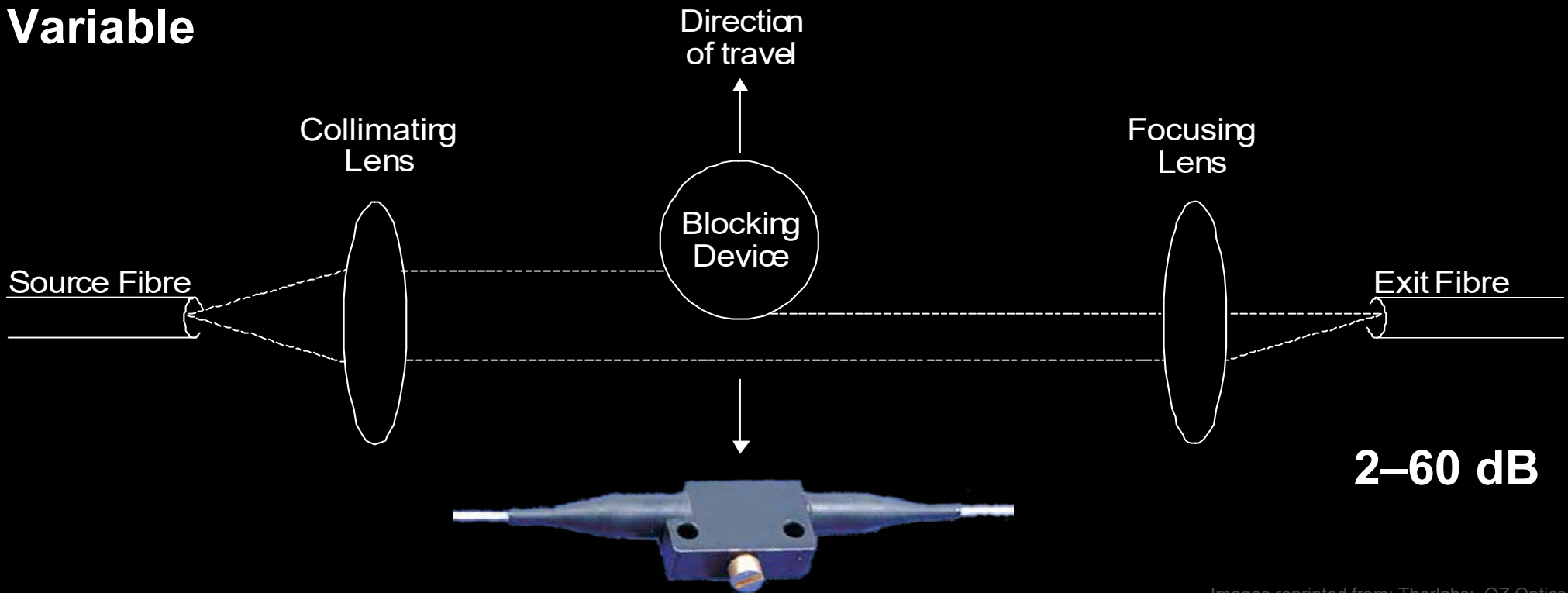

Wavelength filters

Colored glass

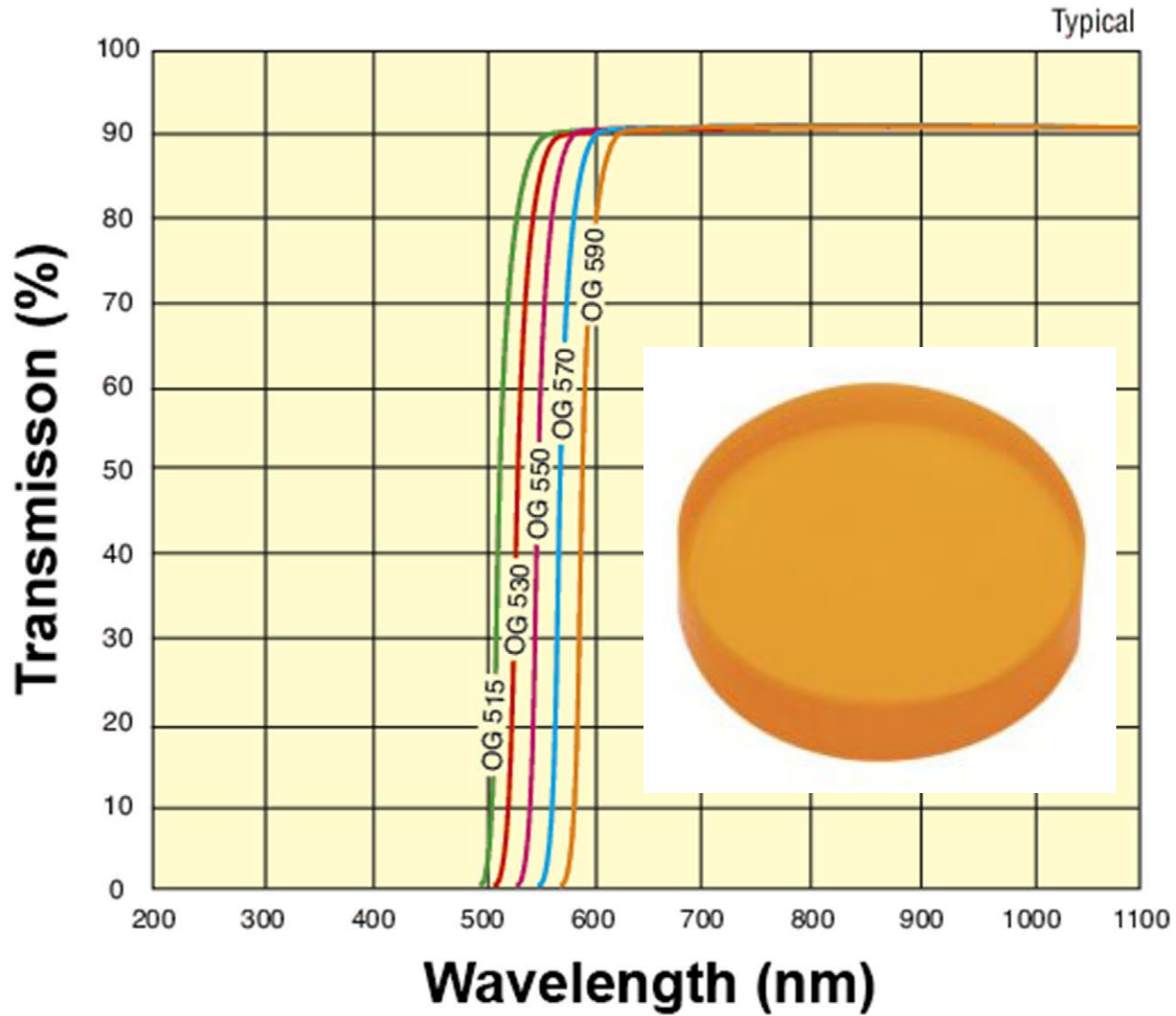

Wavelength filters

Interference filter

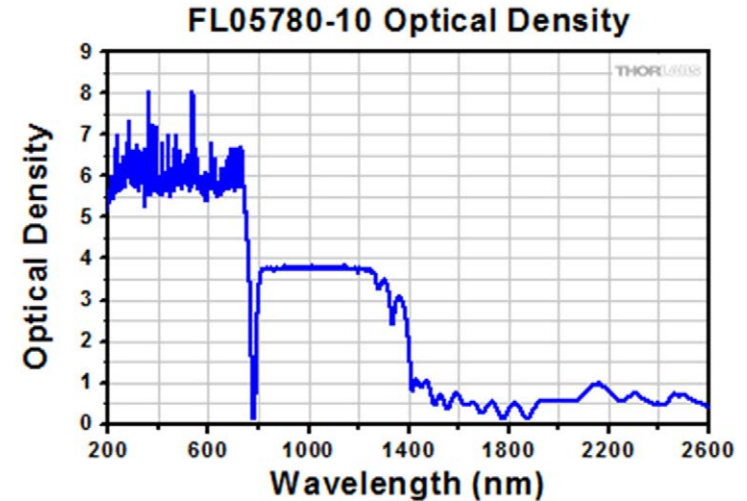
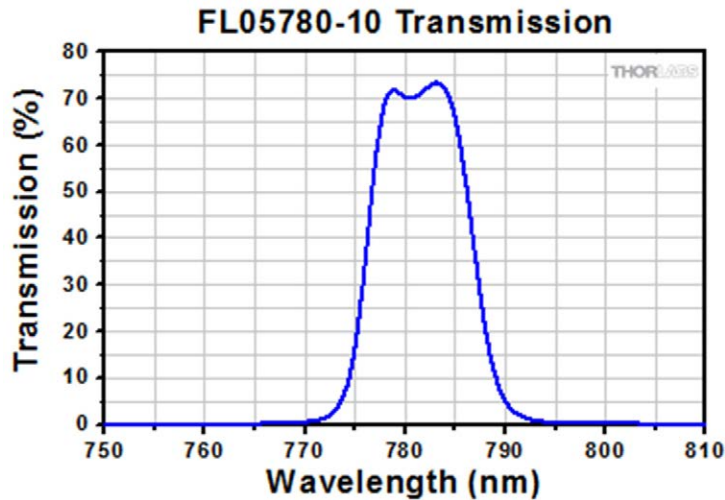
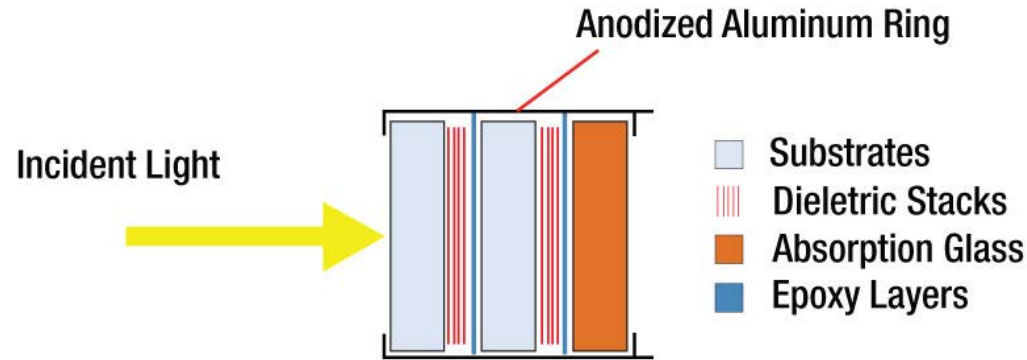

Fiber Bragg grating

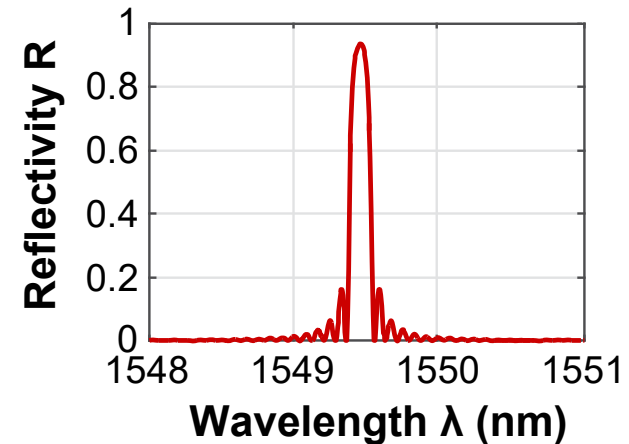
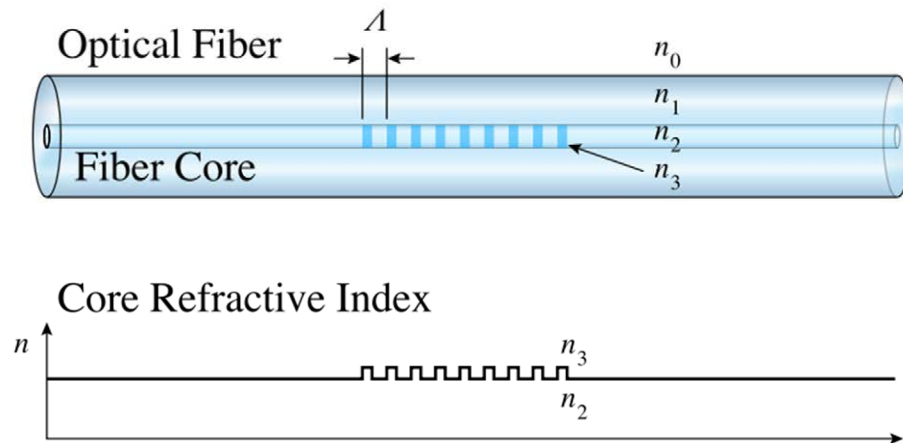

Polarization controller (slow)

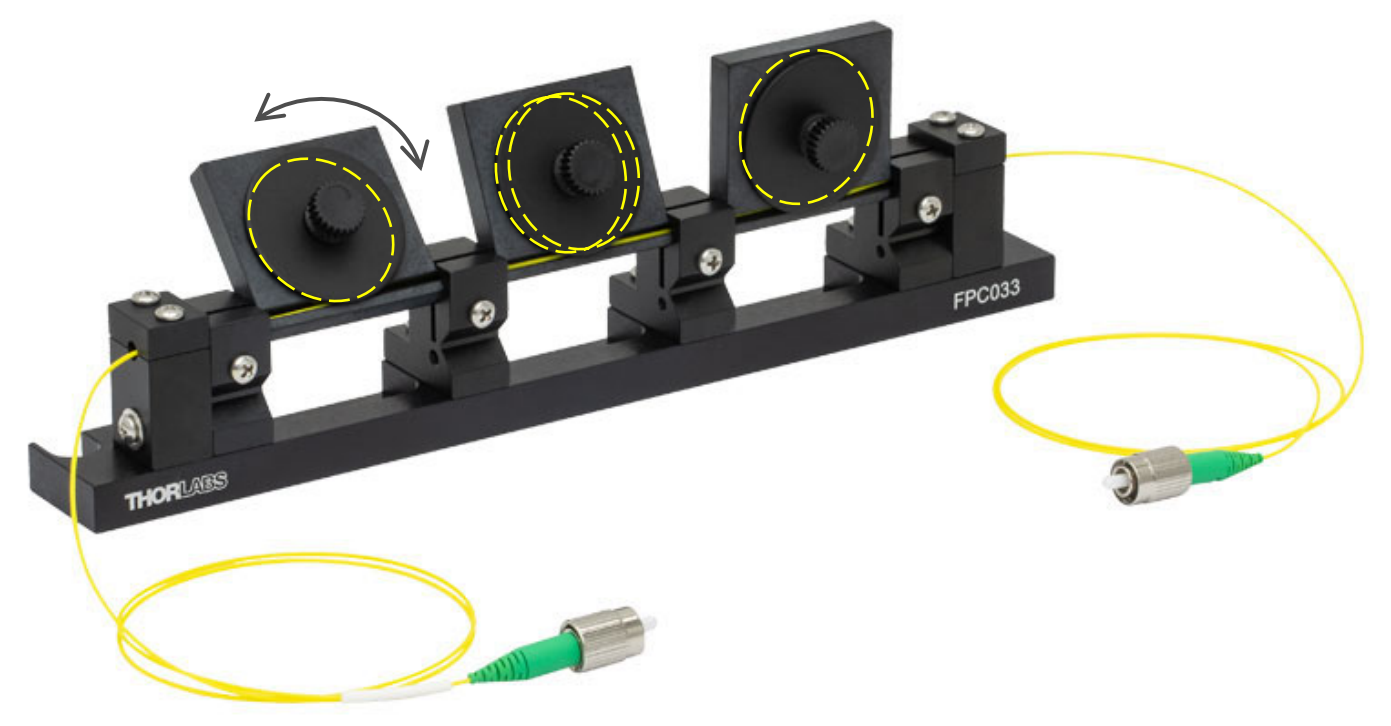
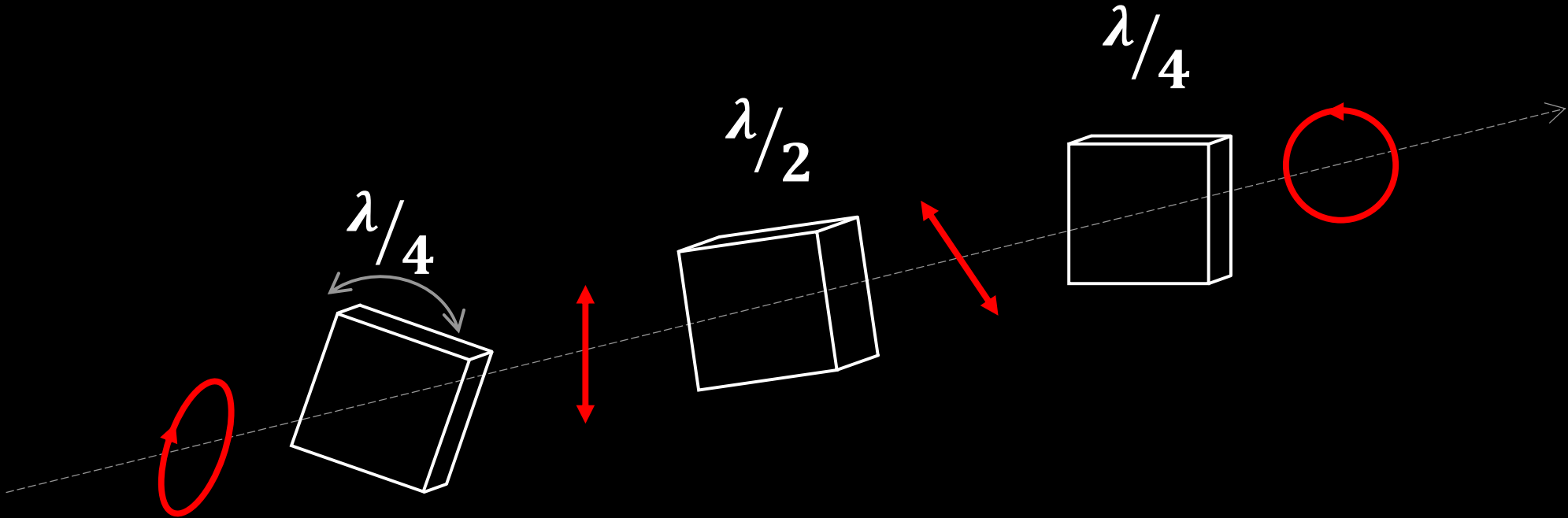
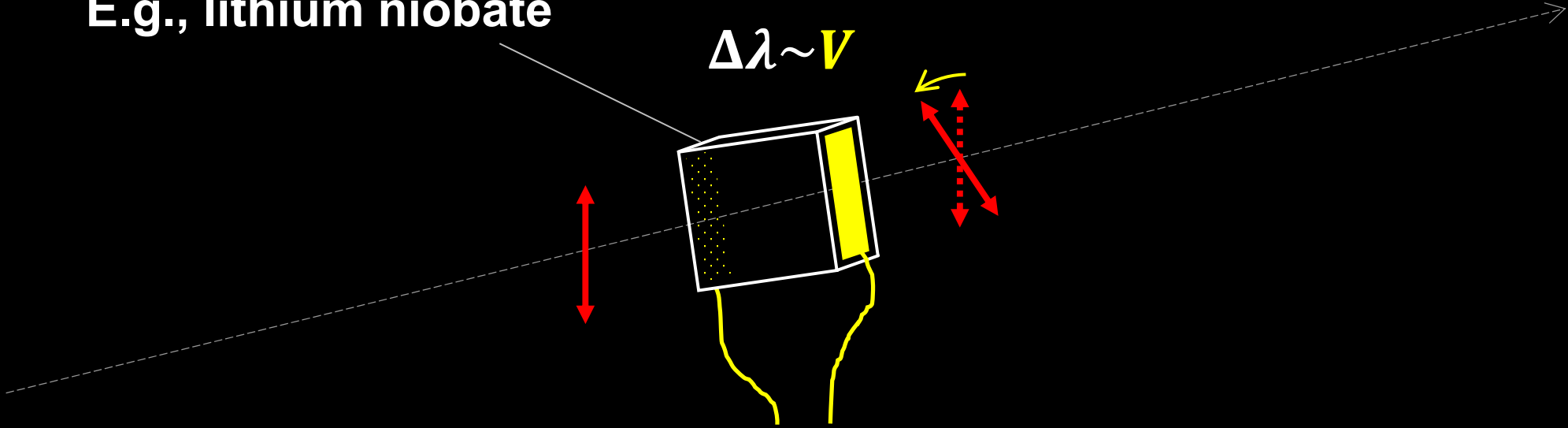

Image reprinted from: Thorlabs

Polarization modulator (fast)

E.g., lithium niobate



$$\Delta\lambda \sim V$$

$$0 \text{ or } V_{\pi}$$

Pockels cell

Phase modulator

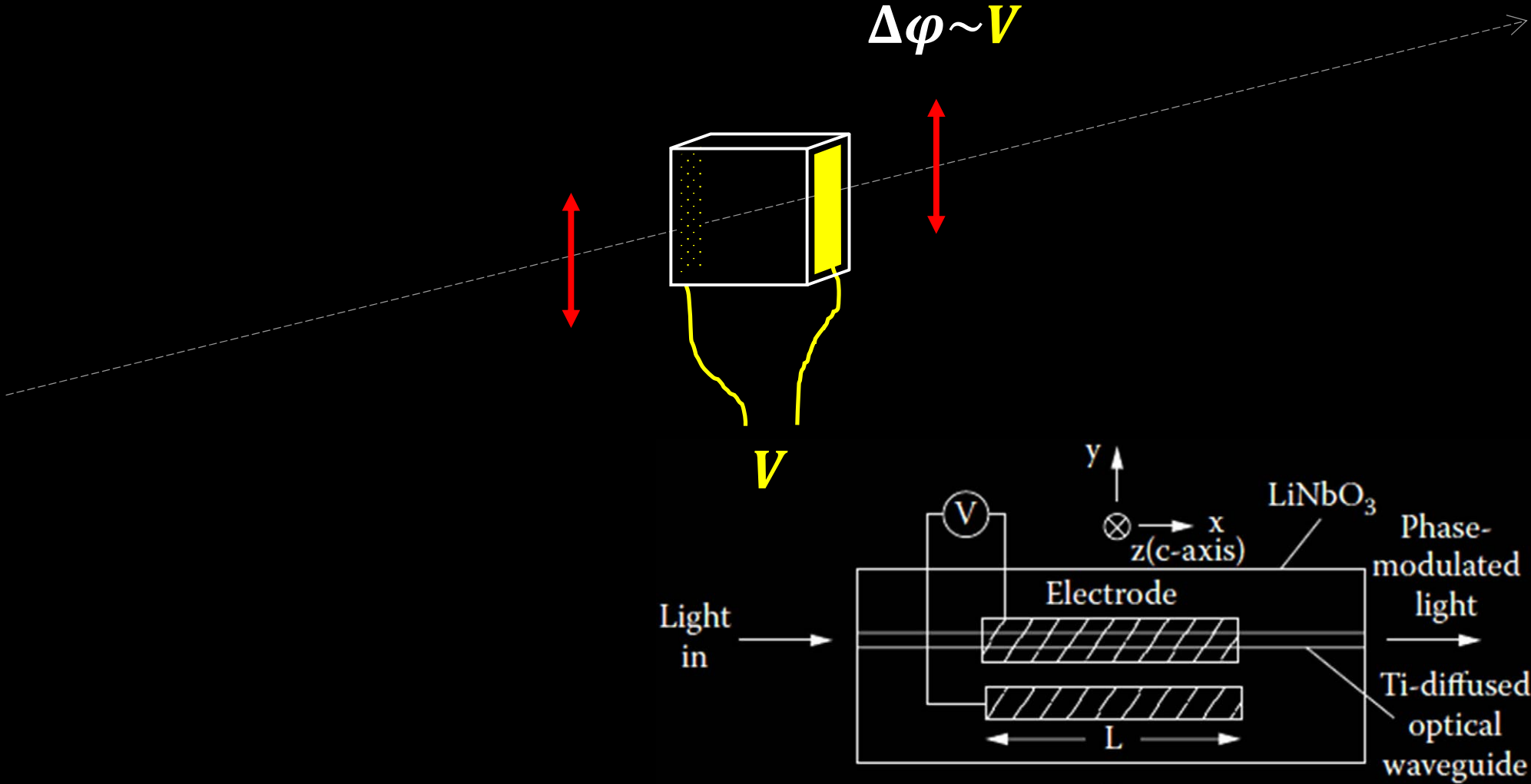

Images reprinted from: A. E.-N. A. Mohamed *et al.*, Int. J. Multidiscip. Sci. Eng. 2, 13 (2011); ixblue Photonics

Intensity modulator

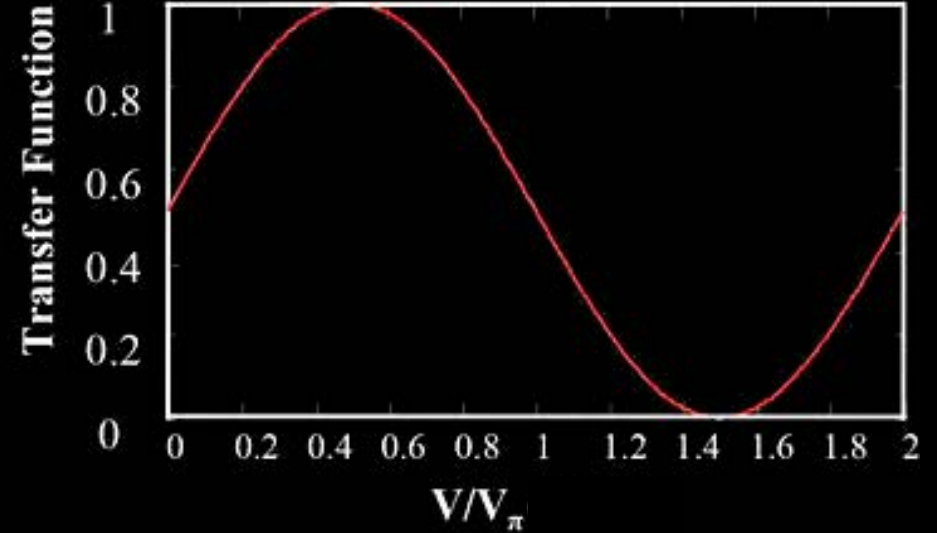
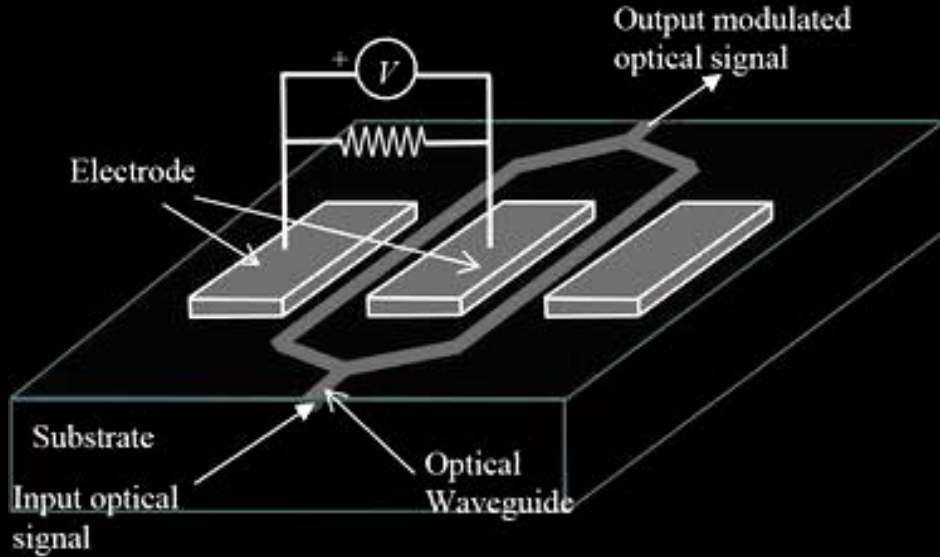

Mach-Zehnder interferometer

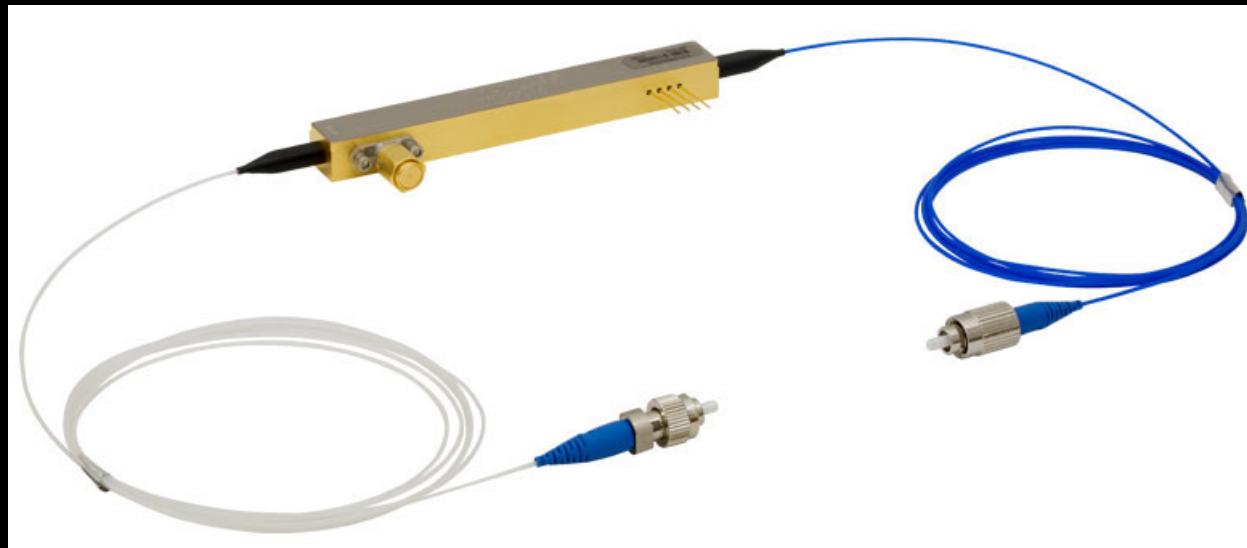

Optical power meters

Thermal

$> 10 \mu\text{W}$

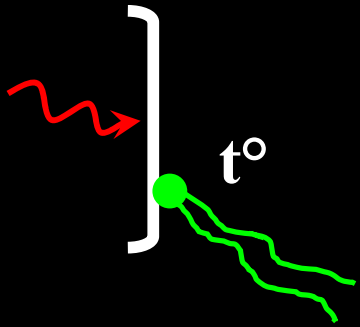

Photodiode

$> 0.1 \text{ nW}$

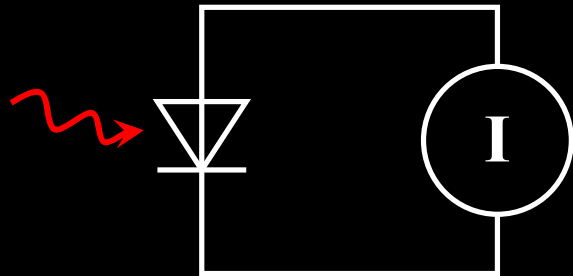

Single-photon detectors

Photon energy

$$E = \frac{hc}{\lambda} = \frac{19.9 \times 10^{-26}}{1.55 \times 10^{-6}} = 1.28 \times 10^{-19} \text{ J}$$



Need a gain mechanism

Photomultiplier tube

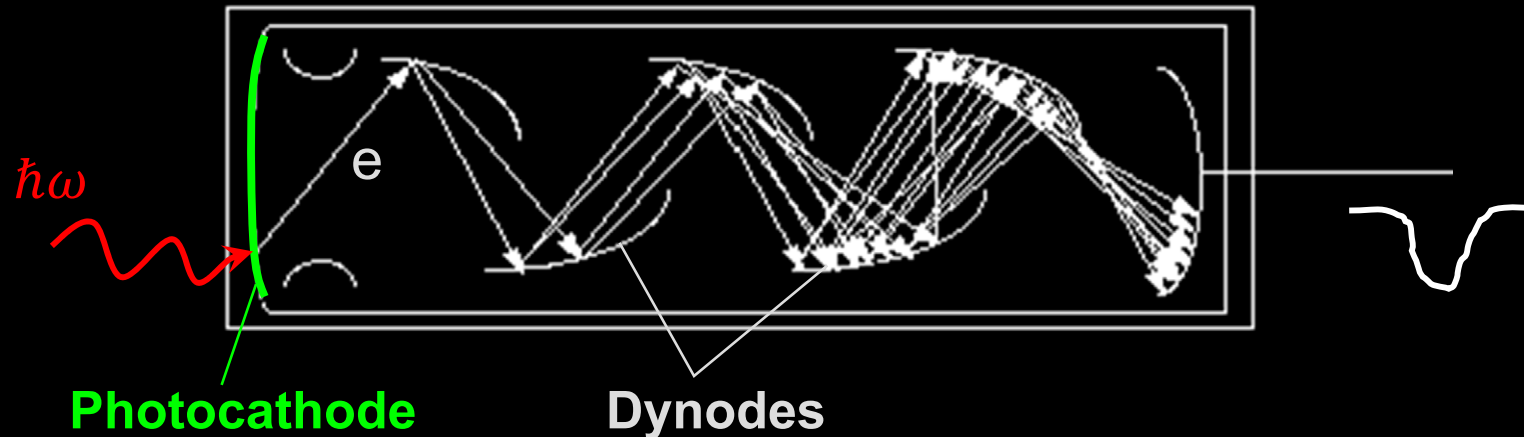

Single-photon avalanche photodiode

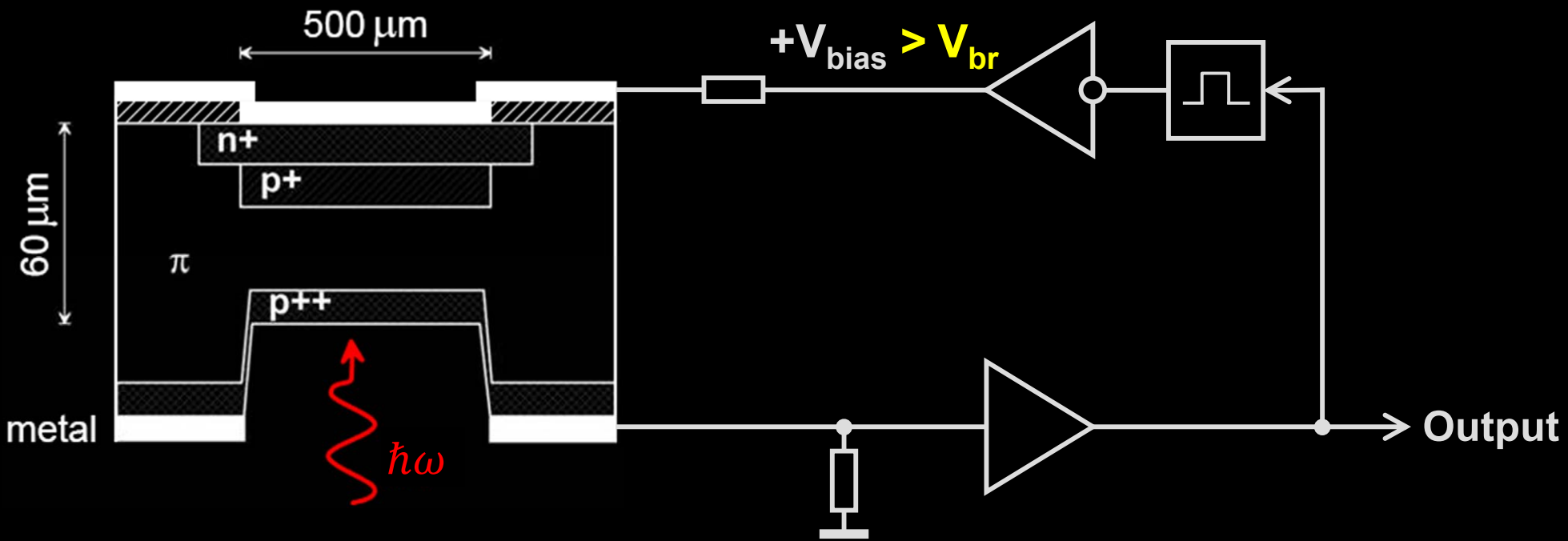
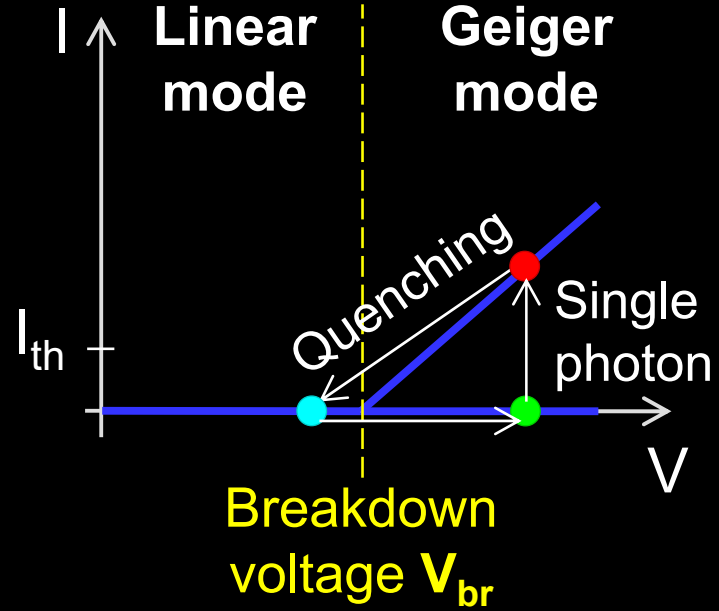
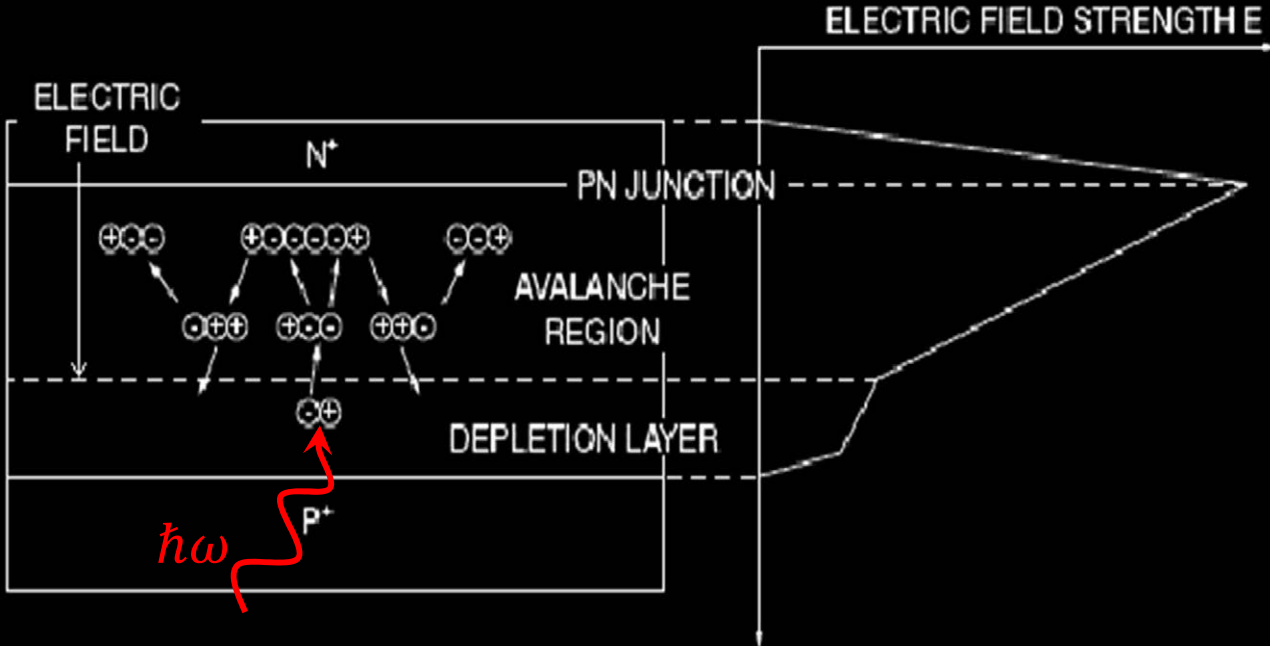

Images reprinted from: <https://www.photonicsonline.com/doc/avalanche-photodiodes-theory-and-applications-0001>; S. Cova *et al.*, J. Mod. Opt. 51, 1267 (2004)

Cooling requirements

Photomultiplier: room temperature

Avalanche photodiode: $-50\text{ }^{\circ}\text{C}$

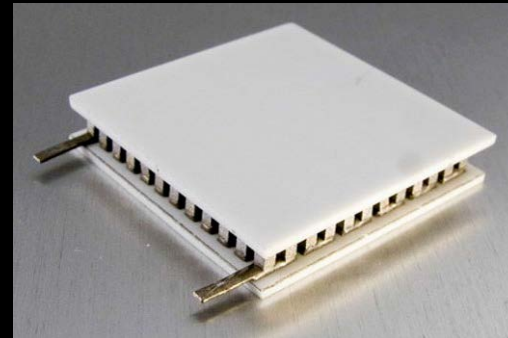

Thermoelectric cooling

0 5 mm

Superconducting nanowire: 4 K

Transition-edge sensor: 100 mK



Assembled fiber optics

Quantum key distribution unit Alice (ID Quantique Clavis2)

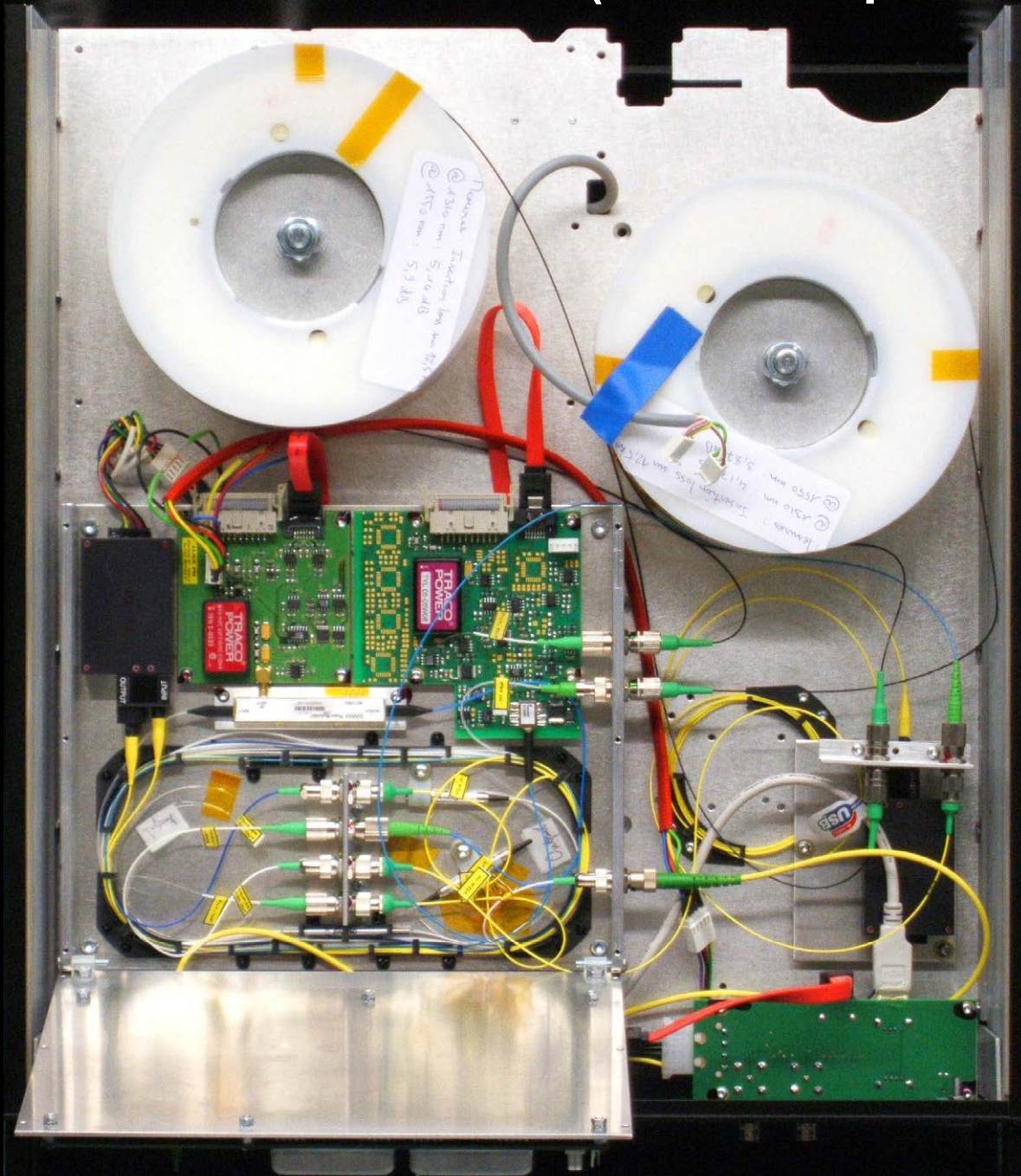

0 100 mm

Assembled free-space optics

Bob's polarization analyzer with single-photon detectors

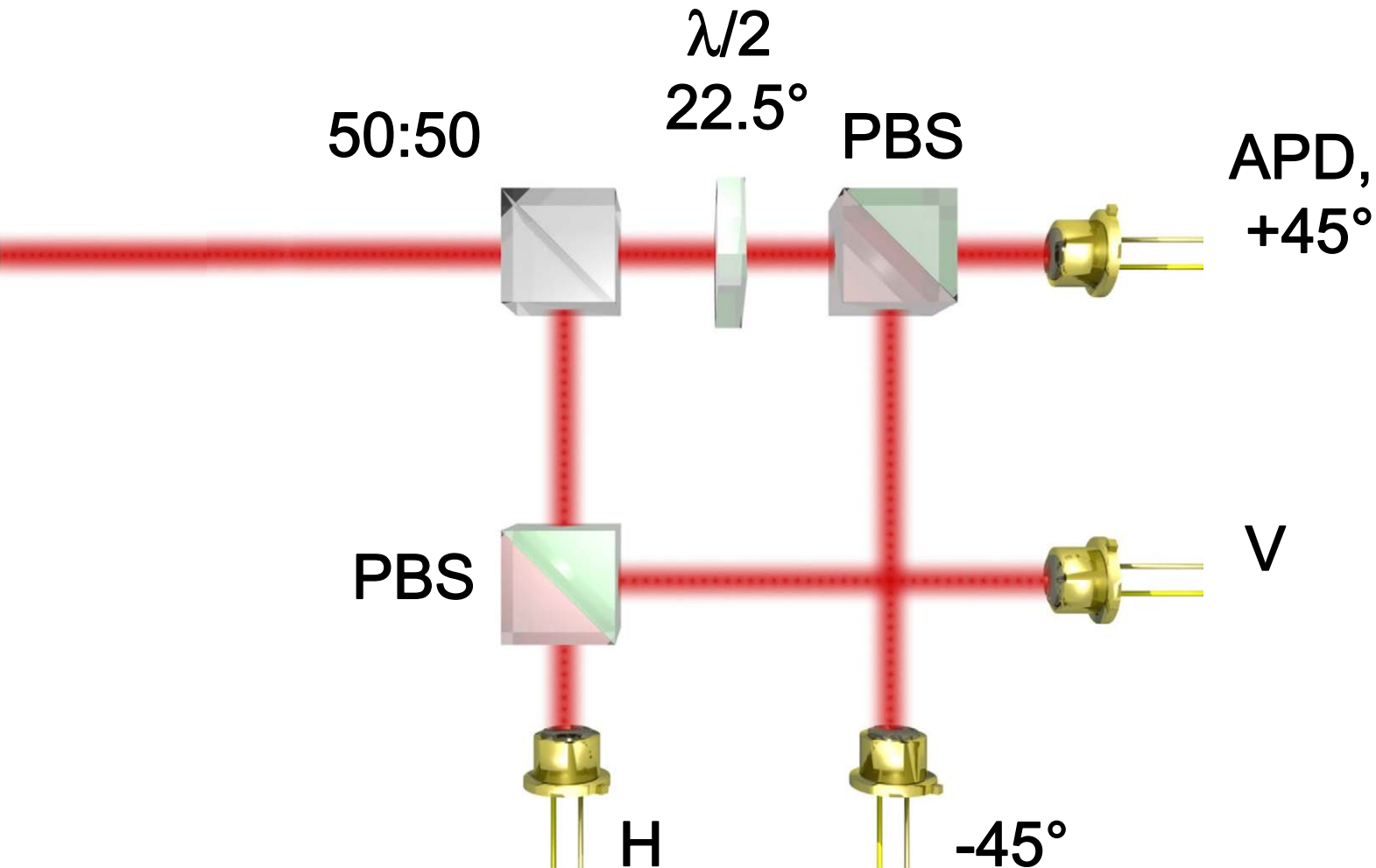

Assembled free-space optics

Bob's polarization analyzer with single-photon detectors

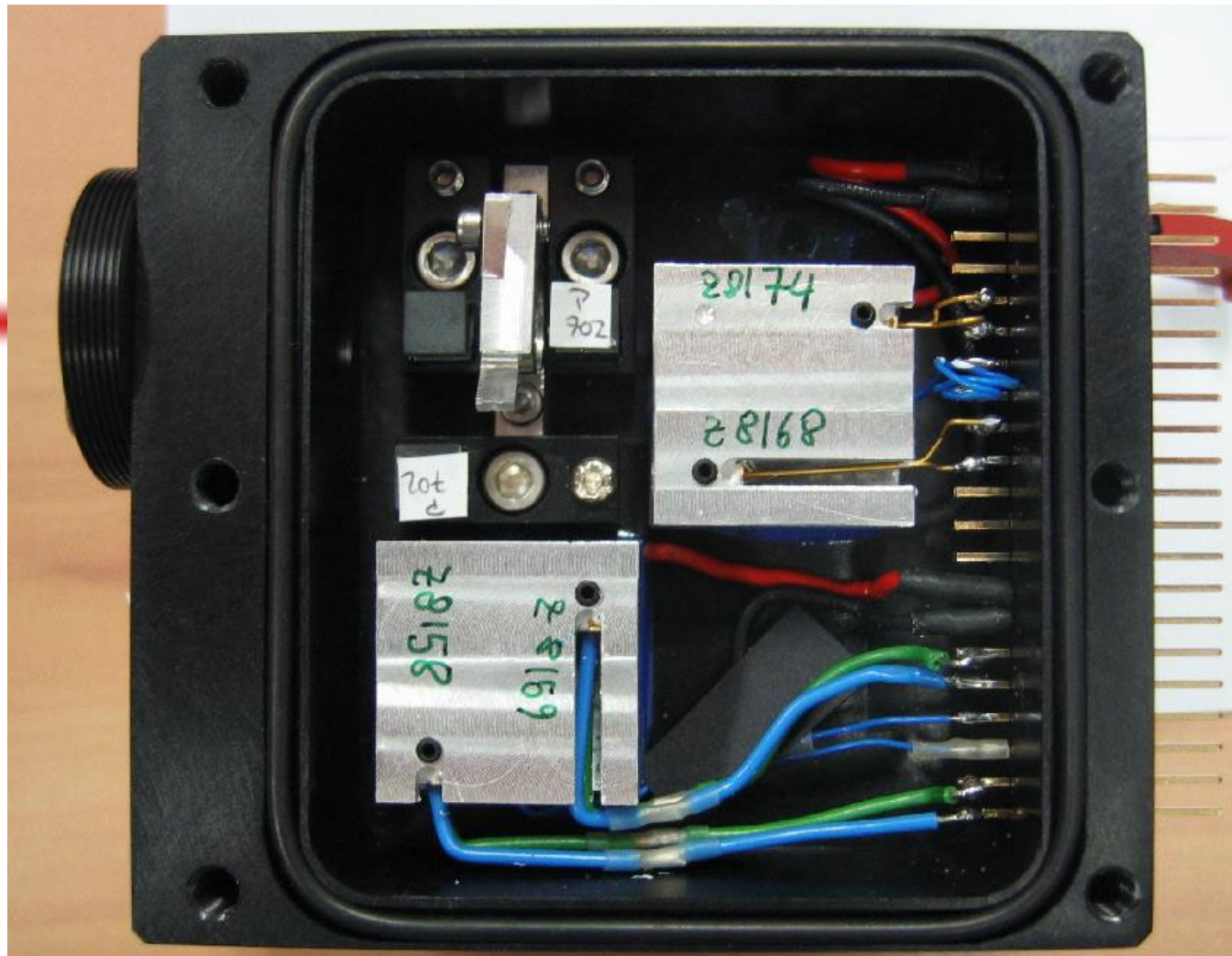

Emerging: integrated optics

Quantum key distribution system

